



Technical catalogue - Edition 05.2014

SACE Emax 2

New low voltage air circuit-breakers

Power and productivity
for a better world™ **ABB**

Index

Main characteristics	1
The ranges	2
Protection trip units	3
Communication devices and systems	4
Accessories	5
Installation	6
Overall dimensions	7
Wiring diagrams	8
Ordering codes	9

SACE Emax 2

Consultation guide



Chapter 1

Main characteristics

Overview of the SACE Emax 2 family, distinctive features of the series, product conformity and service.

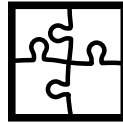

Chapter 5

Accessories

Accessories for SACE Emax 2 circuit-breakers (signaling, control, interlocks, etc..) and for Ekip protection trip units (connectivity, measurements, protection, etc).

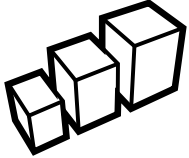

Chapter 2

The ranges

Electrical characteristics of automatic circuit-breakers, switch-disconnectors and derived versions.



Chapter 6

Installation

Installation and circuit-breaker performance in switchgear, installation environment, degree of protection and limiting curves.

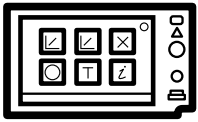

Chapter 3

Protection trip units

Latest generation Ekip protection trip units for power distribution, generator protection and power control.

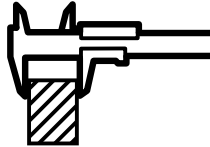

Chapter 7

Overall dimensions

Overall dimensions for fixed circuit-breakers, withdrawable circuit-breakers and accessories.



Chapter 4

Communication devices and systems

Supervision, Energy Management and complete integration in the systems with the possibility of communicating with all the main protocols used in the industrial sector.

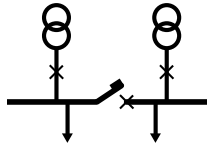

Chapter 8

Wiring diagrams

Circuit-breaker and accessories wiring diagrams.



Chapter 9

Ordering codes

Ordering codes with configuration examples.

Main characteristics

Overview of the SACE Emax 2 family

Guide to selection	1/2
--------------------	-----

Distinctive features of the series

Efficiency	1/3
Control	1/4
Connectivity	1/5
Performance	1/6
Ease of use and safety	1/7

Product conformity

Approvals and certifications	1/9
Quality and Sustainability	1/10

ABB SACE Global Service

1/12

Overview of the SACE Emax 2 family

1 Guide to selection

Ranges available

	E1.2	E2.2	E4.2	E6.2
Automatic circuit-breakers @ 690-1150 V AC	•	•	•	•
Switch-disconnectors @ 690-1150 V AC, 1000 V DC	•	•	•	•
Sectionalizing truck		•	•	•
Earthing switch with making capacity		•	•	•
Earthing truck		•	•	•

Automatic circuit-breakers

Icu (440Vac)	Versione	630	800	1000	1250	1600	2000	2500	3200	4000	5000	6300
200	X											
150	V											E6.2
100	H											
85	S											
66	N											
50	C											
42	B											

Switch-disconnectors

Icw (1s)	Version	630	800	1000	1250	1600	2000	2500	3200	4000	5000	6300
120	X											
100	V											E6.2
85	H											
66	N											
50	N											
42	B											

Protection trip units

Version	Application		
	Distribution	Power control	Generators
Ekip Dip	Protection devices	-	-
Ekip Touch	Protection devices and Measurements	Protection devices and Measurements	-
Ekip Hi-Touch	Protection devices, Measurements, Network Analyzer	Protection devices, Measurements, Network Analyzer	-
Ekip G Touch		Protection devices and Measurements	Protection devices and Measurements
Ekip G Hi-Touch		Protection devices, Measurements, Network Analyzer	Protection devices, Measurements, Network Analyzer

Distinctive features

SACE Emax 2 is a new series of low voltage air circuit-breakers available up to 6300 A and with the ability to efficiently and simply control electrical installations – from the traditional to the more complex – with minimum impact, the new SACE Emax 2 circuit-breakers represent the evolution of a circuit-breaker into a Power Manager.

Efficiency

SACE Emax 2 air circuit-breakers have been designed to manage, with maximum efficiency, all low voltage electrical installations: from industrial plants, naval applications, traditional and renewable power generation installations to buildings, shopping centres, data centres and communication networks.

Achieving maximum efficiency of an electrical installation in order to reduce consumption and waste requires intelligent management of power supplies and energy use. For this reason, the new technologies used in the SACE Emax 2 circuit-breakers allow the productivity and reliability of installations to be optimized, and at the same time, power consumption to be reduced while fully respecting the environment.



1SDC200402F001

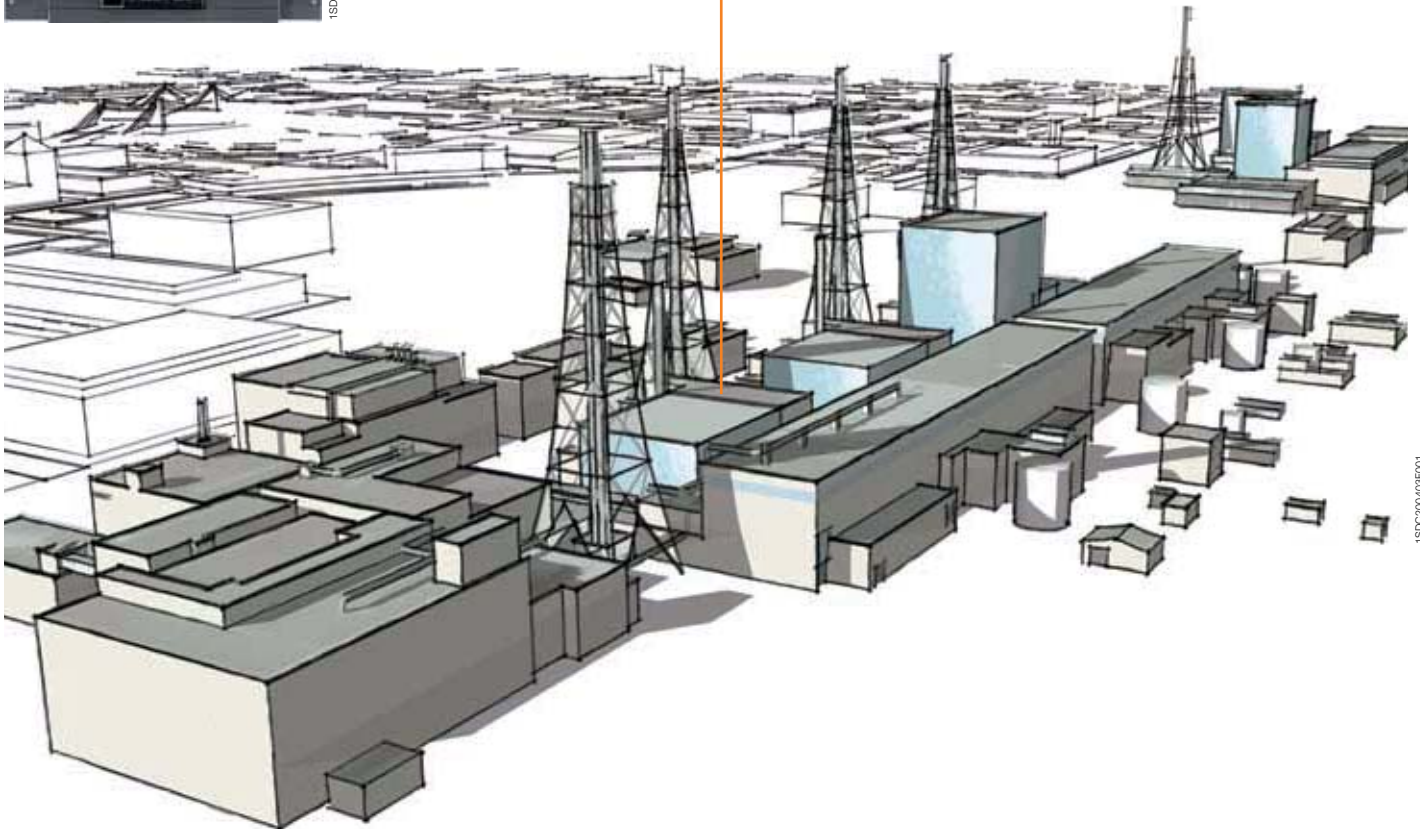

1SDC200403F001

Distinctive features

1

Control

The exclusive **Power Controller** function available on the new SACE Emax 2 circuit-breakers monitors the power managed by the circuit-breaker, keeping it below the limit set by the user. As a result of this more effective use, the peak of power consumed can be limited allowing savings on electricity bills.

The Power Controller, patented by ABB, disconnects non-priority utilities, such as electric car charging stations, lighting or refrigeration units, during the times when consumption limits need to be respected, and connects them again as soon as it is appropriate. When required, it automatically activates auxiliary power supplies such as generator sets. No monitoring system is required: it is sufficient to set the required load limit on Emax 2, which can control any circuit-breaker located downstream, even if it is not equipped with a measurement function. In installations that are already equipped with energy management systems, the load limit can also be modified remotely.

SACE Emax 2 circuit-breakers are equipped with a new generation of protection trip units that are easy to programme and read. The Ekip Touch trip units measure power and energy with precision and store the most recent alarms, events and measurements in order to prevent faults to the installation or trip effectively when necessary. On request, the **Network Analyzer** function is also available, which controls the quality of absorbed power in real time and with extreme precision.

In addition, the innovative Ekip Touch and Hi-Touch trip units in the G version include all the functions of generator protection switchgear, offering a safe control solution that is ready to use. No external devices, wiring or inspections are required.

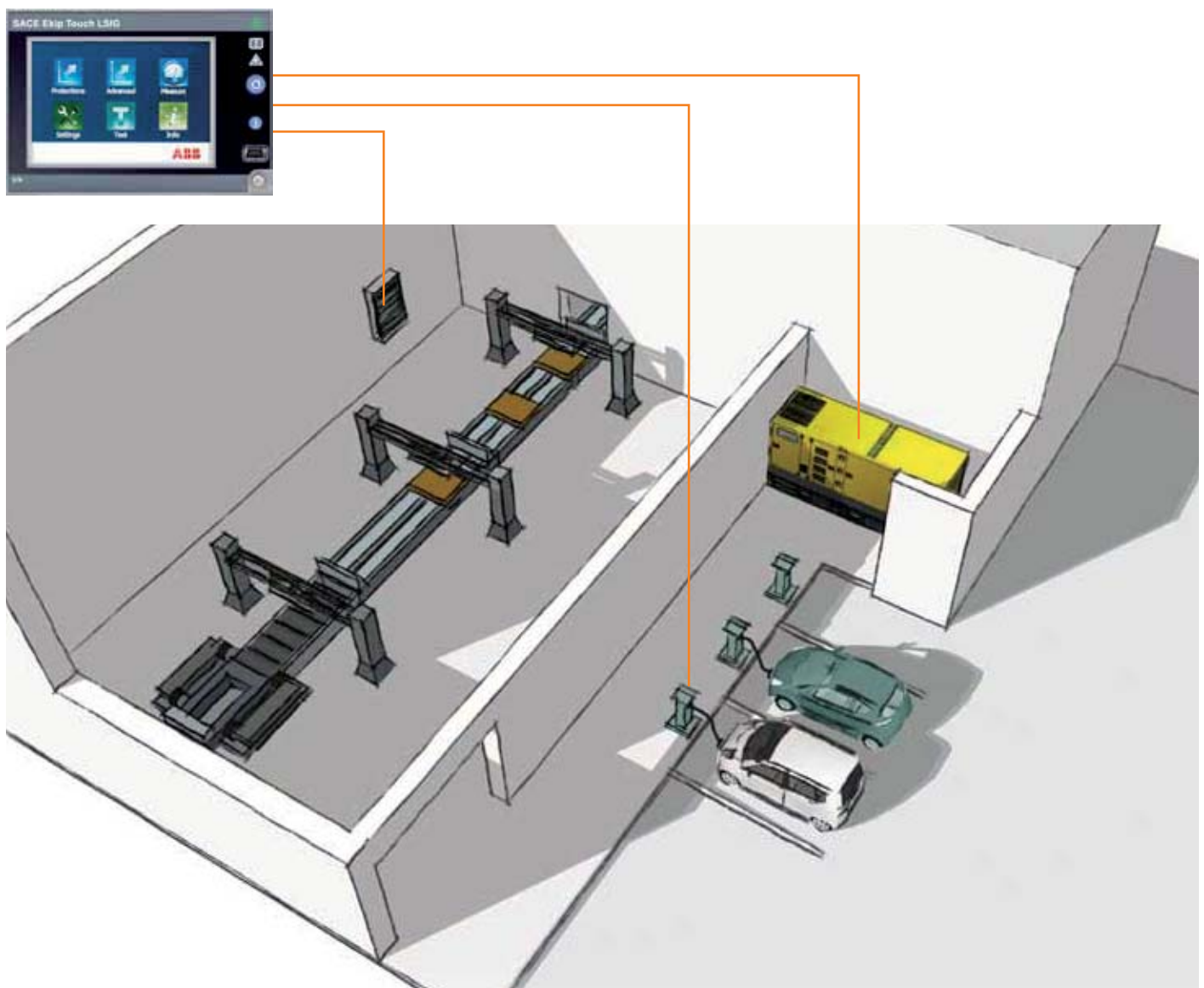

1SDC200023D0203

Connectivity

SACE Emax 2 series circuit-breakers can be integrated perfectly into all automation and energy management systems to improve productivity and energy consumption and to carry out remote service.

All circuit-breakers can be equipped with communication units available for use with Modbus, Profibus, and DeviceNet protocols as well as the modern Modbus TCP, Profinet and EtherNet IP protocols. The cartridge-type modules can be easily installed directly on the terminal box, even at a later date.

Furthermore, the integrated IEC61850 communication module enables connection to automation systems widely used in medium voltage power distribution to create intelligent networks (Smart Grids).

Accurate measurements of current, voltage, power and energy are all available by means of the communication modules.

The trip units themselves can be used as multimeters that display the measurements available, or the Ekip Multimeter can be connected in the front of the switchgear without the need for external instruments and bulky transformers.

All circuit-breaker functions are also accessible via the Internet, in complete safety, through the Ekip Link switchgear supervision system and the Ekip Control Panel operator panel.

The power and auxiliary connections are optimized to simplify connection to the switchgear. The power terminals, which can be oriented horizontally or vertically, have been designed for the most common busbars, while the push-in connections of the auxiliaries ensure immediate and safe wiring.



1SDC200406F001

Distinctive features

1

Performance

The SACE Emax 2 range is made up of 4 sizes: E1.2, E2.2, E4.2 and E6.2 up to 6300A, which enable switchgear of compact dimensions and high ratings to be built with busbars of reduced length and cross-section.

The protection trip units, auxiliary connections and main accessories are the same throughout the range to simplify design and installation. Furthermore, the sizes from E2.2 to E6.2 have the same height and depth.

The rating levels are updated and uniform throughout the sizes to meet the demands and needs of today's installations, from 42kA to 200kA, and to standardize switchgear projects.

High short-time currents, together with the efficiency of the protection functions, guarantee complete selectivity in all situations. Accurate design and choice of materials enable optimization of the overall dimensions of the circuit-breaker. In this way switchgear of compact dimensions can be built and outstanding savings at the same performance can be obtained.

In particular:

- **E1.2** offers 1,600A with an interrupting rating of up to 66kA and withstand current of 50kA for 1 second in an extremely compact structure. In the three and four pole version, it offers the sturdiness of SACE Emax with reduced dimensions and enables switchgear of 66kA to be built in units of 400mm, which is indispensable in places where reduced dimensions are essential, such as naval and offshore installations.
- **E2.2** enables in the three pole version ratings of up to 2,500A to be achieved in switchgear with a width of 400mm. In addition, it provides short-circuit currents up to 100kA and 85kA for 1 second.
- **E4.2** is the new 4,000A circuit-breakers designed to withstand high currents with a withstand rating of 100kA for 1 second without the need for particular precautions.
- **E6.2** is the top of the range, with an interrupting rating of 200kA and a structure that allows 6,300A to be reached, even in complex installation conditions.

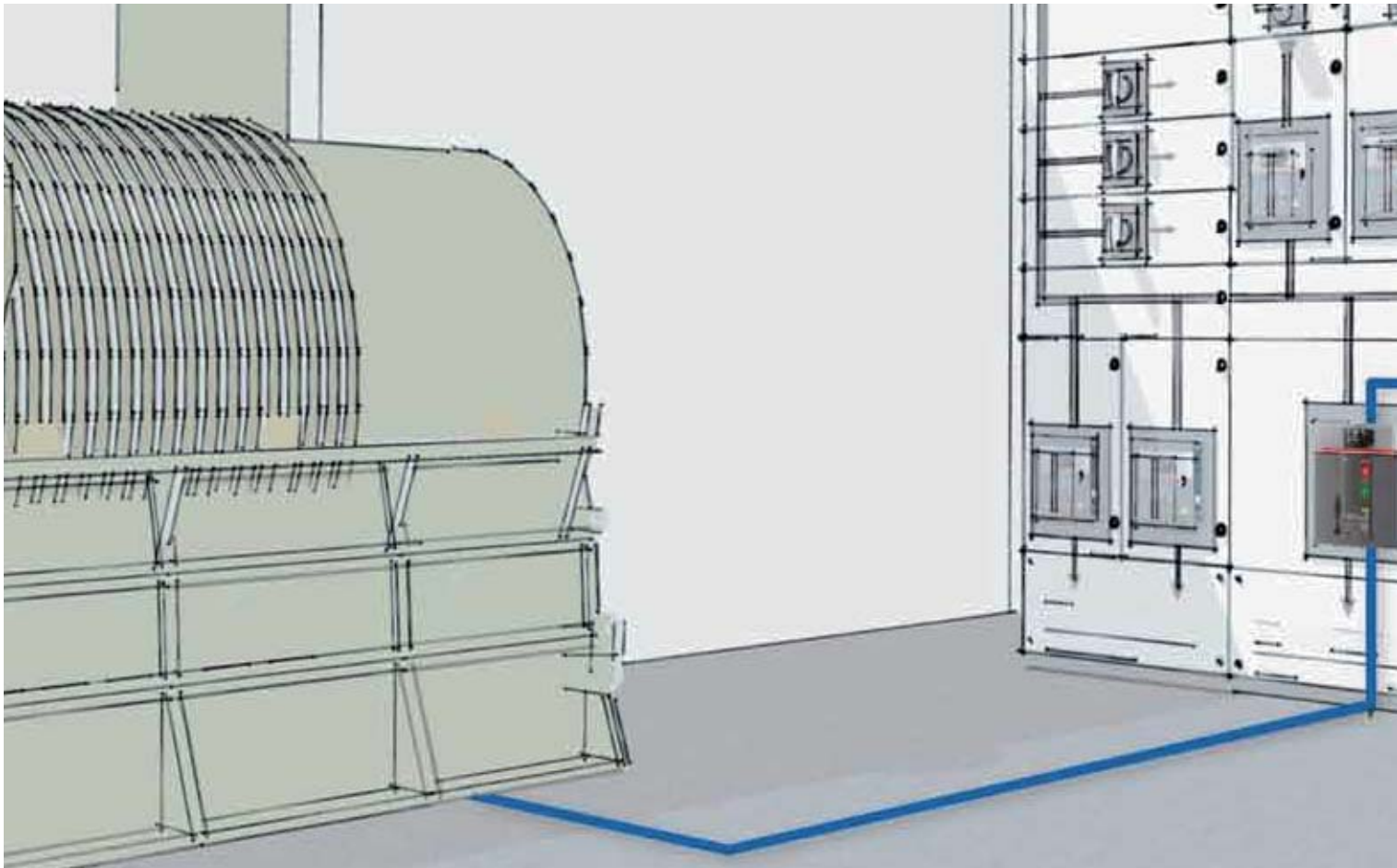

Ease of use and safety

The entire range is available in fixed and withdrawable versions, with double insulation between the front of the switchgear and the live parts to ensure operation in complete safety. The circuit-breakers can be powered indifferently from above or below. All essential information is available in the central area of the front shield and enables immediate identification of the status of the circuit-breaker: open, closed, ready to close, charged and discharged springs.

Maintenance is simply and safe. Thanks to the new front shield, the main accessories can be frontally accessed without completely removing it.

The withdrawable circuit-breaker is inserted and removed via dedicated guide rails that simplify movement. The correct movement from racked-in, test isolated, to racked-out position is guaranteed by a lock in each position. As a further guarantee of safety, the shutters of the fixed part can be locked from the front when the circuit-breaker is removed. The shutters of the upper terminals are independent of those of the lower terminals to facilitate checking and maintenance operations.

The Ekip Touch protection trip units are equipped with a large colour touch-screen display which enables safe and intuitive operation. Furthermore the Ekip units can be programmed and consulted from a tablet, smart phone or portable PC via the Ekip Connect application, which allows the parameters of the safety devices calculated in the DOC software to be set automatically.

The trip units are easily interchangeable from the front of the circuit-breaker, and all communication units can be installed directly on the terminal box with a few simple operations.

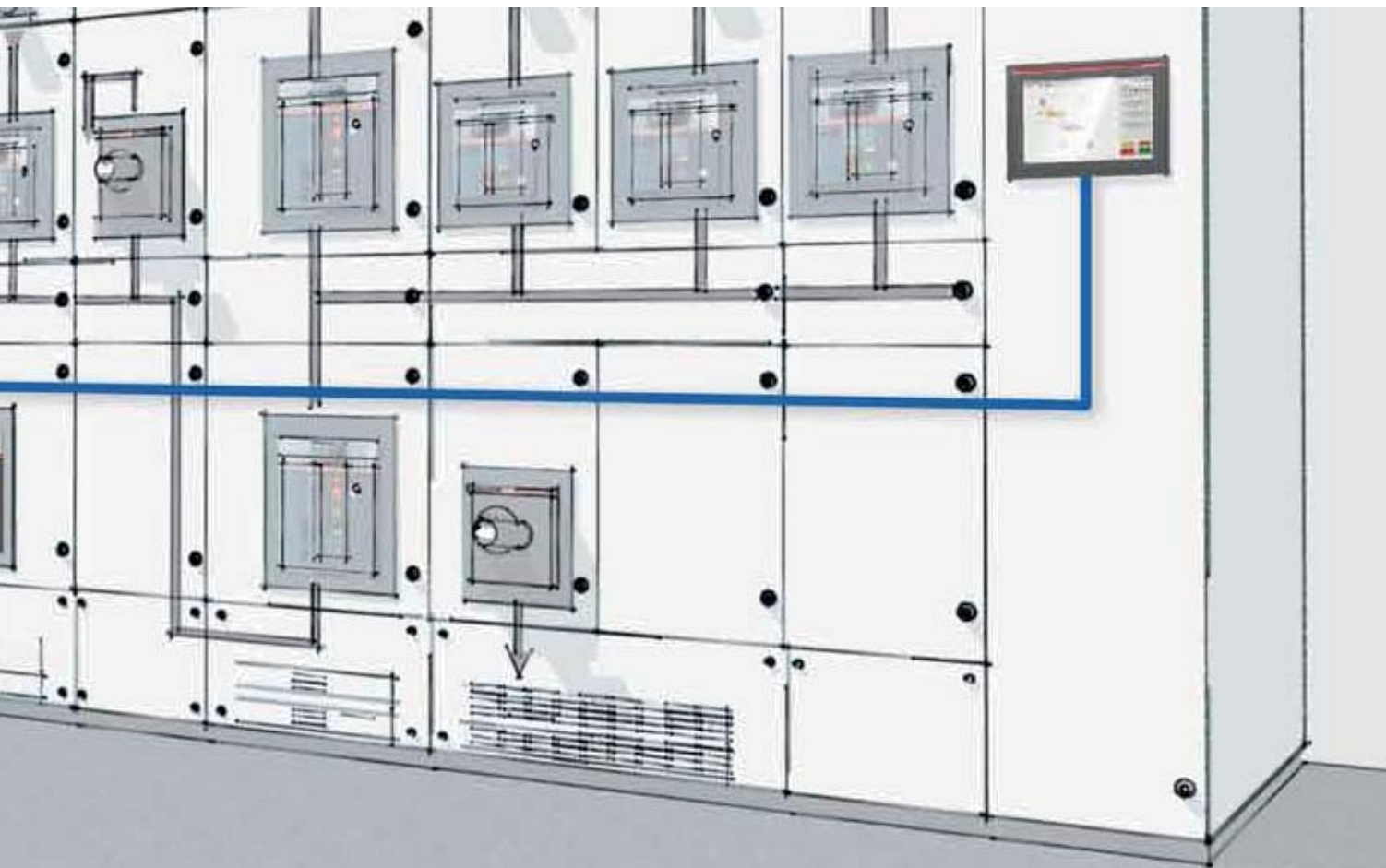

1SDC200407F001

Distinctive features

1



Key

- 1 Trademark and size of circuit- breaker
- 2 SACE Ekip protection trip unit
- 3 Pushbutton for manual opening
- 4 Pushbutton for manual closing
- 5 Lever to manually charge closing springs
- 6 Electrical rating plate
- 7 Mechanical device to signal circuit-breaker open "O" and closed "I"
- 8 Signal for springs charged or discharged
- 9 Mechanical signalling of overcurrent release tripped
- 10 Size and serial number

Product conformity

SACE Emax 2 circuit-breakers and their accessories conform to IEC 60947, EN 60947 international Standard

Approvals and certifications

SACE Emax 2 circuit-breakers and their accessories conform to the international IEC 60947, EN 60947 (harmonized in 30 CENELEC countries), CEI EN 60947 and IEC 61000 Standards and comply with the following EC directives:

- "Low Voltage Directives" (LVD) no. 2006/95/EC
- "Electromagnetic Compatibility Directive" (EMC) no. 2004/108/EC.

The ABB air circuit-breakers include a range that has been certified according to American UL 1066 Standards; it is also certified by the Russian certification body GOST (Russia Certificate of Conformity) and has achieved China CCC Certification (China Compulsory Certification).

Certification of conformity with the above-mentioned product Standards is carried out in compliance with the European EN 45011 Standard by the Italian certification body ACAE (Association for the Certification of Electrical Equipment), which is recognized by the European organization LOVAG (Low Voltage Agreement Group), and by the Swedish Intertek SEMKO certification organization Intertek Semko which is recognized by the international organization IECEE.

The main versions of the devices are about to be approved by the following shipping registers



Registro Italiano Navale (RINA): Italian

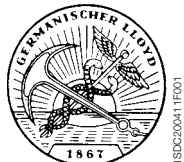

Germanischer Lloyd (GL): Deutsch



Russian Maritime Register of Shipping (RMRS): Russian



Lloyd's Register of Shipping (LR): English



Bureau Veritas (BV): French



Nippon Kaiji Kyokai (NKK): Japan



American Bureau Shipping (ABS): American



Det Norske Veritas (DNV): Norway

For the types of certified circuit-breakers, certified ratings and corresponding validity, please contact ABB SACE.

Product conformity

1

Quality and Sustainability: company efficiency and integrated management systems. Quality, Sustainability and Customer Satisfaction have always been ABB SACE's major commitment.

The involvement of all company departments and organization of processes have led the company to develop, implement and certify management systems in compliance with international Standards:

- ISO 9001 for quality management
- IRIS for the quality of supplies in the railway sector (International Railway Industry Standards)
- ISO 14001 for environmental management
- OHSAS 18001 for the management of the health and safety of employees in the workplace
- SA 8000 for the management of social responsibility.



The ABB SACE testing laboratory, accredited by ACCREDIA in compliance with ISO/IEC 17025 Standard, provides both ABB and external customers with a qualified service for performing certification tests on devices and electric equipment of low and medium voltage in accordance with the relevant product Standards.

Thanks to the implementation of systems and their integration (Integrated Management System), ABB SACE, with a view to continuous improvement, has implemented processes with a focus on:

- quality, preventing defects and faults along the entire supply chain
- environment, reviewing production processes in terms of ecology and waste reduction, rationalizing the consumption of raw materials and energy, preventing pollution, containing noise emissions and reducing the quantity of rejects in the production processes
- health and safety of employees, offering a healthy and safe workplace in all of the various stages of work with a “zero accident objective”
- social responsibility, guaranteeing the respect of human rights and the absence of any discrimination throughout the supply chain, and offering a favourable and transparent working atmosphere.

A further commitment aimed at safeguarding the environment has been achieved by assessing products' life cycles (LCA, Life Cycle Assessment): this includes the assessment and improvement of the environmental performance of products from the engineering stage throughout their entire life cycle. The materials, processes and packaging used are chosen with a view to optimising the actual environmental impact of each product, including its energy efficiency and recyclability.



ABB SACE Global Service

1

ABB's technical assistance service offers solutions aimed at supporting the customer in all stages of the lifespan of the circuit-breaker in service and covering the entire chain of value; ABB is present from the moment of selection to the end of the life of the product, thereby guaranteeing the investments of its customers.

ABB supplies annual updates regarding the evolution of the circuit-breaker ranges (Life Cycle Management) and for each product it provides details of associated services and the level of support available, so that customers can choose the products and spare parts best suited to their needs.

ABB's organisation offers services that include installation and commissioning, technical training on the use and maintenance of products, the supply of original spare parts, corrective and preventive maintenance, equipment diagnostics, modernisation of systems with upgrades and retrofitting kits, consultancy services and personalised maintenance and service contracts. All this is supported by one of the most extensive global sales and service networks.

Retrofitting kit

Through continuous research targeted at the needs of the customer, ABB SACE Service has developed innovative retrofitting kits in order to simplify and speed up installation of a new circuit-breaker, updating the customer's investment with the latest technology available and with very limited down times.

The retrofitting kit between Emax2 and Emax is a refill solution: it is therefore possible to replace the withdrawable version of Emax with an equivalent Emax2 model without changing the switchboard busbars, by simply removing the fixed part of Emax replacing it with a fixed part of Emax2 which has been suitably modified with dedicated terminals.

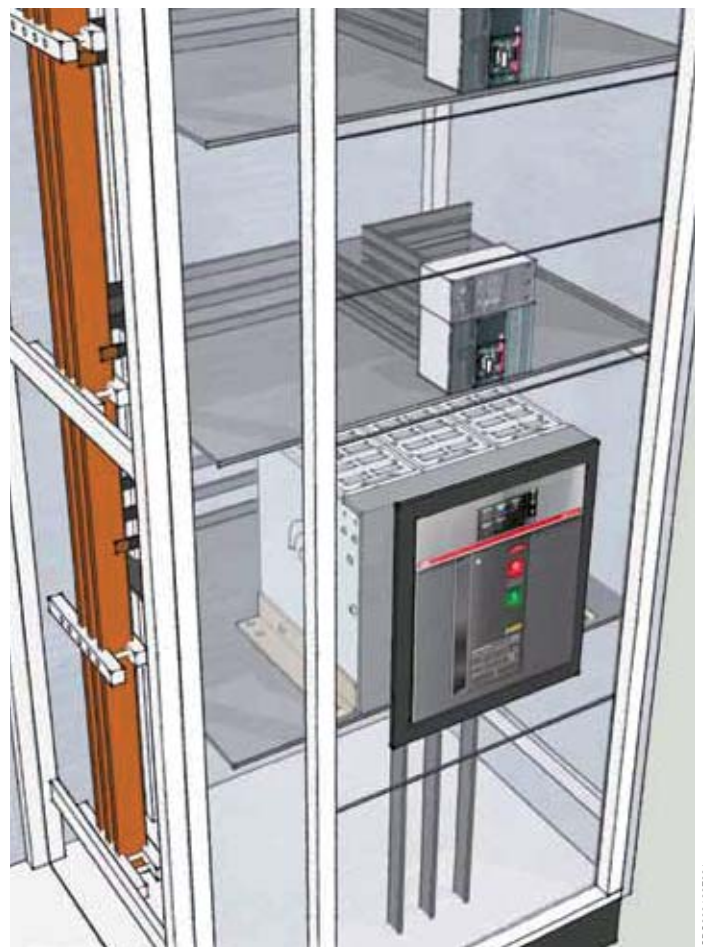
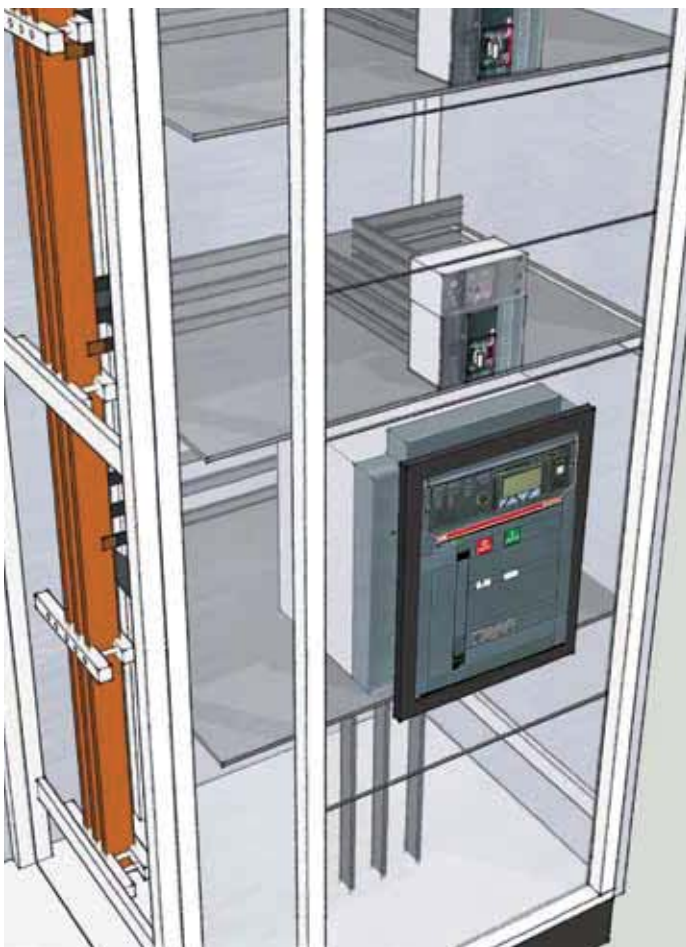

The Ranges

[SACE Emax 2 automatic circuit-breakers](#) [2/2](#)

[SACE Emax 2 switch-disconnectors](#) [2/4](#)

[SACE Emax 2 automatic circuit-breakers
for applications up to 1150V AC](#) [2/6](#)

[SACE Emax 2 switch-disconnectors
for applications up to 1150V AC](#) [2/8](#)

[SACE Emax 2 switch-disconnectors
for applications up to 1000V DC](#) [2/10](#)

[SACE Emax 2 derived versions](#) [2/12](#)

2

SACE Emax 2 automatic circuit-breakers

2

Common data

Rated service voltage Ue	[V]	690
Rated insulation voltage Ui	[V]	1000
Rated impulse withstand voltage Uimp	[kV]	12
Frequency	[Hz]	50 - 60
Number of poles		3 - 4
Version		Fixed - Withdrawable
Isolation behaviour		IEC 60947-2



1SDC20042-4F001

SACE Emax 2

Performance levels			E1.2			
			B	C	N	L
Rated uninterrupted current Iu @ 40°C		[A]	630	630	250	630
		[A]	800	800	630	800
		[A]	1000	1000	800	1000
		[A]	1250	1250	1000	1250
		[A]	1600	1600	1250	
		[A]			1600	
		[A]				
Neutral pole current-carrying capacity for 4-pole CBs		[%Iu]	100	100	100	100
Rated ultimate short-circuit breaking capacity Icu	400-415 V	[kA]	42	50	66	150
	440 V	[kA]	42	50	66	130
	500-525 V	[kA]	42	42	50	100
	690 V	[kA]	42	42	50	60
Rated service short-circuit breaking capacity Ics		[%Icu]	100	100	100 ¹⁾	100
Rated short-time withstand current Icw	(1s)	[kA]	42	42	50	15
	(3s)	[kA]	24	24	36	-
Rated short-circuit making capacity (peak value) Icm	400-415 V	[kA]	88	105	145	330
	440 V	[kA]	88	105	145	286
	500-525 V	[kA]	88	88	105	220
	690 V	[kA]	88	88	105	132
Utilization category (according to IEC 60947-2)			B	B	B	A
Breaking	Breaking time for I<Icw	[ms]	40	40	40	40
	Breaking time for I>Icw	[ms]	25	25	25	10
Dimensions	H - Fixed/Withdrawable	[mm]	296/363.5	296/363.5	296/363.5	296/363.5
	D - Fixed/Withdrawable	[mm]	183/271	183/271	183/271	183/271
	W - Fixed 3p/4p/4p FS	[mm]	210/280			
	W - Withdrawable 3p/4p/4p FS	[mm]	278/348			
Weights (CB with trip unit and current sensor)	Fixed 3p/4p	kg	14/16			
	Withdrawable 3p/4p/4p FS including fixed part	kg	38/43			

1) Ics : 50kA for 400V...440V voltage; 2) Ics: 125kA for 400V...440V voltage; 3) E4.2H 3200A: 66 Icw (3s)

SACE Emax 2

Mechanical and electrical life with regular ordinary maintenance prescribed by the manufacturer			E1.2			
		[Iu]	≤ 1000	1250	1600	1250 L
		[No. cycles x 1000]	20	20	20	20
	Frequency	[Oper./Hour]	60	60	60	60
Electrical life	440 V	[No. cycles x 1000]	8	8	8	3
	690 V	[No. cycles x 1000]	8	6,5	6,5	1
	Frequency	[Oper./Hour]	30	30	30	30



1SDC20042BF001



1SDC20042BF001



1SDC20042TF001

E2.2				E4.2				E6.2			
B	N	S	H	N	S	H	V	H	V	X	
1600	800	250	800	3200	3200	3200	2000	4000	4000	4000	
2000	1000	800	1000	4000	4000	4000	2500	5000	5000	5000	
	1250	1000	1250				3200	6300	6300	6300	
	1600	1250	1600				4000				
	2000	1600	2000								
	2500	2000	2500								
		2500									
100	100	100	100	100	100	100	100	50-100	50-100	50-100	
42	66	85	100	66	85	100	150	100	150	200	
42	66	85	100	66	85	100	150	100	150	200	
42	66	66	85	66	66	85	100	100	130	130	
42	66	66	85	66	66	85	100	100	100	120	
100	100	100	100	100	100	100	100 ²⁾	100	100	100	
42	66	66	85	66	66	85	100	100	100	120	
42	50	50	66	50	66	73 ³⁾	75	100	100	100	
88	145	187	220	145	187	220	330	220	330	440	
88	145	187	220	145	187	220	330	220	330	440	
88	145	145	187	145	145	187	220	220	286	286	
88	145	145	187	145	145	187	220	220	220	264	
B	B	B	B	B	B	B	B	B	B	B	
40	40	40	40	40	40	40	40	40	40	40	
25	25	25	25	25	25	25	25	25	25	25	
371/425	371/425	371/425	371/425	371/425	371/425	371/425	371/425	371/425	371/425	371/425	
270/383	270/383	270/383	270/383	270/383	270/383	270/383	270/383	270/383	270/383	270/383	
276/366				384/510				762/888/1014			
317/407				425/551				803/929/1069			
41/53				56/70				109/125/140			
54/99				110/136				207/234/260			

E2.2				E4.2				E6.2			
< 1600	1600	2000	2500	< 2500	2500	3200	4000	4000	5000	6300	
25	25	25	20	20	20	20	15	12	12	12	
60	60	60	60	60	60	60	60	60	60	60	
15	12	10	8	10	8	7	5	4	3	2	
15	10	8	7	10	8	7	4	4	2	2	
30	30	30	30	20	20	20	20	10	10	10	

SACE Emax 2 switch-disconnectors

Switch-disconnectors, identified with the abbreviation “/MS”, are devices that satisfy the isolating specifications provided by the IEC 60947-3 Standard. The switch-disconnectors are derived from the corresponding automatic circuit-breakers, and they have the same dimensions and accessory options. This version differs from the automatic circuit-breakers only because of the absence of protection trip units.

2

Common data

Rated service voltage Ue	[V]	690
Rated insulation voltage Ui	[V]	1000
Rated impulse withstand voltage Uimp	[kV]	12
Frequency	[Hz]	50 - 60
Number of poles		3- 4
Version		Fixed - Withdrawable
Isolation behaviour		IEC 60947-3



SACE Emax 2

SACE Emax 2			E1.2		
Performance levels			B/MS	N/MS	
Rated uninterrupted current I _u @ 40°C		[A]	630	250	
		[A]	800	630	
		[A]	1000	800	
		[A]	1250	1000	
		[A]	1600	1250	
		[A]		1600	
Neutral pole current-carrying capacity for 4-pole CBs		[%I _u]	100	100	
Rated short-time withstand current I _{cw}	(1s)	[kA]	42	50	
	(3s)	[kA]	24	36	
Rated short-circuit making capacity (peak value) I _{cm}	400-415 V	[kA]	88	105	
	440 V	[kA]	88	105	
	500-525 V	[kA]	88	105	
	690 V	[kA]	88	105	
Utilization category (according to IEC 60947-3)			AC-23A	AC-23A	
Dimensions	H - Fixed / Withdrawable	[mm]	296 / 363.5	296 / 363.5	
	D - Fixed / Withdrawable	[mm]	183 / 271	183 / 271	
	W - Fixed 3p/4p/4p FS	[mm]	210 / 280		
	W - Withdrawable 3p/4p/4p FS	[mm]	278 / 348		

1) E4.2H/MS 3200A: 66kA I_{cw} (3s)

SACE Emax 2

SACE Emax 2			E1.2		
Mechanical and electrical life with regular ordinary maintenance prescribed by the manufacturer		[I _u]	< 1000	1000	1600
		[No. cycles x 1000]	20	20	20
	Frequency	[Oper./Hour]	60	60	60
Electrical life	440 V	[No. cycles x 1000]	8	8	8
	690 V	[No. cycles x 1000]	8	6.5	6.5
	Frequency	[Oper./Hour]	30	30	30

The device, when in the open position, guarantees an isolating distance between the main contacts of the circuit-breaker that is sufficient to ensure that the installation downstream is not live.

Furthermore the switch-disconnectors, if used with an external protection relay with maximum delay of 500ms, enable a breaking capacity at a maximum rated operating voltage (Ue) equal to the value of rated short-time withstand current (Icw) for one second.



E2.2			E4.2			E6.2		
B/MS	N/MS	H/MS	N/MS	H/MS	V/MS	H/MS	X/MS	
1600	800	800	3200	3200	2000	4000	4000	
2000	1000	1000	4000	4000	2500	5000	5000	
	1250	1250			3200	6300	6300	
	1600	1600			4000			
	2000	2000						
	2500	2500						
100	100	100	100	100	100	50-100	50-100	
42	66	85	66	85	100	100	120	
42	50	66	50	75 ¹⁾	75	100	100	
88	145	187	145	187	220	220	264	
88	145	187	145	187	220	220	264	
88	145	187	145	187	220	220	264	
88	145	187	145	187	220	220	264	
AC-23A	AC-23A	AC-23A	AC-23A	AC-23A	AC-23A	AC-23A	AC-23A	
371 / 425	371 / 425	371 / 425	371 / 425	371 / 425	371 / 425	371 / 425	371 / 425	
270 / 383	270 / 383	270 / 383	270 / 383	270 / 383	270 / 383	270 / 383	270 / 383	
276 / 366			384 / 510			762 / 888 / 1014		
317 / 407			425 / 551			803 / 929 / 1069		

E2.2				E4.2				E6.2			
< 1600	1600	2000	2500	< 2500	2500	3200	4000	4000	5000	6300	
25	25	25	20	20	20	20	15	12	12	12	
60	60	60	60	60	60	60	60	60	60	60	
15	12	10	8	10	8	7	5	4	3	2	
15	10	8	7	10	8	7	4	4	2	2	
30	30	30	30	20	20	20	20	10	10	10	

SACE Emax 2 automatic circuit-breakers for applications up to 1150V AC

ABB SACE offers a solution designed for electrical applications with voltages up to 1150V in alternating current. The 1150V AC range, which maintains the same dimensions and accessories as the standard 690V AC range, is identified by the letters “/E”.

2

Common data

Rated service voltage U_e	[V]	1150
Rated insulation voltage U_i	[V]	1250
Rated impulse withstand voltage U_{imp}	[kV]	12
Frequency	[Hz]	50 - 60
Number of poles		3- 4
Version		Fixed - Withdrawable
Isolation behaviour		IEC 60947-2



SACE Emax 2

E1.2

Performance levels

N/E

Rated uninterrupted current I_u @ 40°C		[A]	630
		[A]	800
		[A]	1000
		[A]	1250
		[A]	1600
		[A]	
Neutral pole current-carrying capacity for 4-pole CBs		[% I_u]	100
Rated ultimate short-circuit breaking capacity I_{cu}	1000 V	[kA]	30
	1150 V	[kA]	25
Rated service short-circuit breaking capacity I_{cs}		[% I_{cu}]	100
Rated short-time withstand current I_{cw} (1s)		[kA]	25
	(3s)	[kA]	25
Rated short-circuit making capacity (peak value) I_{cm}	1000 V	[kA]	63
	1150 V	[kA]	53
Utilization category (according to IEC 60947-3)			B

SACE Emax 2

E1.2

Mechanical and electrical life with regular ordinary maintenance prescribed by the manufacturer		[I_u]	< 1000	1000	1600
		[No. cycles x 1000]	20	20	20
	Frequency	[Oper./Hour]	60	60	60
Electrical life	1150 V	[No. cycles x 1000]	1	1	1
	Frequency	[Oper./Hour]	30	30	30



1SDC20042BF001



1SDC20042BF001



1SDC200427F001

E2.2			E4.2			E6.2		
H/E			H/E			X/E		
800			3200			4000		
1000			4000			5000		
1250						6300		
1600								
2000								
2500								
100			100			50 - 100		
30			50			65		
30			30			65		
100			100			100		
30			50			65		
30			30			65		
63			105			143		
53			105			143		
B			B			B		

E2.2			E4.2			E6.2		
< 2000	2000	2500	< 3200	3200	4000	4000	5000	6300
25	25	20	20	20	15	12	12	12
60	60	60	60	60	60	60	60	60
2	2	2	1	1	1	1	1	1
30	30	30	20	20	20	10	10	10

SACE Emax 2 switch-disconnectors for applications up to 1150V AC

The switch-disconnectors for applications at 1150V, identified by the letters “/E” and “/MS”, are derived from the corresponding standard automatic circuit-breakers, of which maintain the overall dimensions and the possibility of mounting accessories. The switch-disconnectors are not equipped with Ekip protection trip units. By means of external protection relay with 500 ms maximum timing, the Icu breaking capacity is equal to the value of Icw (1s).

2

Common data

Rated service voltage Ue	[V]	1150
Rated insulation voltage Ui	[V]	1250
Rated impulse withstand voltage Uimp	[kV]	12
Frequency	[Hz]	50 - 60
Number of poles		3- 4
Version		Fixed - Withdrawable
Isolation behaviour		IEC 60947-3



1SDC200428FV01

SACE Emax 2

E1.2

Performance levels

N/E MS

Rated uninterrupted current Iu @ 40°C		[A]	630
		[A]	800
		[A]	1000
		[A]	1250
		[A]	1600
		[A]	
Neutral pole current-carrying capacity for 4-pole CBs		[%Iu]	100
Rated short-time withstand current Icw	(1s)	[kA]	25
	(3s)	[kA]	25
Rated short-circuit making capacity (peak value) Icm	1000 V	[kA]	53
	1150 V	[kA]	53

SACE Emax 2

E1.2

Mechanical and electrical life with regular ordinary maintenance prescribed by the manufacturer		[Iu]	< 1000	1000	1600
		[No. cycles x 1000]	20	20	20
Electrical life	Frequency	[Oper./Hour]	60	60	60
	1150 V	[No. cycles x 1000]	1	1	1
	Frequency	[Oper./Hour]	30	30	30



1SDC200425F001



1SDC200439F001



1SDC200431F001

E2.2			E4.2			E6.2		
H/E MS			H/E MS			X/E MS		
800			3200			4000		
1000			4000			5000		
1250						6300		
1600								
2000								
2500								
100			100			50 - 100		
30			50			65		
30			30			65		
53			105			143		
53			105			143		

E2.2			E4.2			E6.2		
< 2000	2000	2500	< 3200	3200	4000	4000	5000	6300
25	25	20	20	20	15	12	12	12
60	60	60	60	60	60	60	60	60
2	2	2	1	1	1	1	1	1
30	30	30	20	20	20	10	10	10

SACE Emax 2 Switch-disconnectors for applications up to 1000V DC

ABB SACE extends its solutions to applications in direct current with a range of switch-disconnectors for applications up to 1000V, which comply with the international IEC60947-3 standard.

For all applications in which integrated protection is requested in addition to isolation, ABB SACE offers SACE Emax automatic circuit-breakers with PR122/DC and PR123/DC. For further information, please refer to the technical catalogue "SACE Emax DC. Low voltage air circuit-breakers for direct current applications".

2

Common data

Rated service voltage U_e	[V]	750 (3p) / 1000 (4p)
Rated insulation voltage U_i	[V]	1000
Rated impulse withstand voltage U_{imp}	[kV]	12
Number of poles		3- 4
Version		Fixed - Withdrawable
Isolation behaviour		IEC 60947-3



SACE Emax 2

Performance levels

				E1.2		
				N/DC MS		
Rated uninterrupted current I_u @ 40°C		[A]		800		
		[A]		1250		
		[A]				
		[A]				
		[A]				
		[A]				
Poles			3	4	4	
Rated service voltage U_e			750	750	1000	
Rated insulation voltage U_i			1000	1000	1000	
Rated short-time withstand current I_{cw}	(1s)	[kA]	20	25	20	
Rated short-circuit making capacity (peak value) I_{cm}	750 V	[kA]	40	53	40	
	1000 V	[kA]			40	
Utilization category (according to IEC 60947-3)						

SACE Emax 2

				E1.2	
Mechanical and electrical life with regular ordinary maintenance prescribed by the manufacturer		[l_u]		< 1000	1250
		[No. cycles x 1000]		20	20
	Frequency	[Oper./Hour]		60	60
Electrical life	1000 V	[No. cycles x 1000]		1	1
	Frequency	[Oper./Hour]			

Note: by means of external protection relay with 500 ms maximum timing, the breaking capacity I_{cu} at the maximum rated use voltage is equal to the value of I_{cw} (1s).



1SDC200425F001



1SDC200439F001



1SDC200431F001

E2.2			E4.2			E6.2		
S/DC MS			H/DC MS			X/DC MS		
1250			1250			4000		
1600			1600			5000		
2000			2000			6300		
2500			2500					
			3200					
			4000					
3	4	4	3	4	4	3	4	4
750	750	1000	750	750	1000	750	750	1000
1000	1000	1000	1000	1000	1000	1000	1000	1000
25	40	25	40	50	40	65	65	65
53	84	53	84	105	84	143	143	143
		53			84			143

E2.2			E4.2			E6.2		
< 2000	2000	2500	< 3200	3200	4000	4000	5000	6300
25	25	20	20	20	15	12	12	12
60	60	60	60	60	60	60	60	60
2	2	2	1	1	1	1	1	1

SACE Emax 2 derived versions

Safety is an indispensable requirement that must always be guaranteed in electrical installations. In this regard, ABB SACE offers devices developed to further increase safety standards during inspection and maintenance activities on electrical installations.

In particular, in a withdrawable version, ABB SACE Emax 2 offers:

2

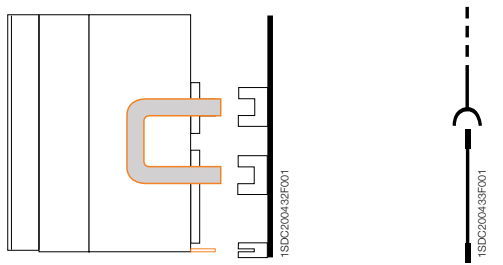

- **Sectionalizing truck CS:** in normal operating conditions of the electrical circuit, this device is inserted in the fixed part and short-circuits the upper and lower terminals of the power circuit. When maintenance activities need to be carried out, the sectionalizing truck is removed and the part of the system involved is isolated. The device can be accessorised with a keylock and padlocks for locking in the withdrawn position.

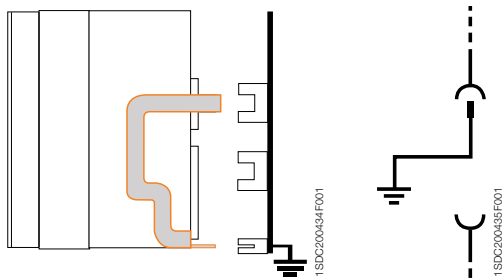

- **Earthing truck MT:** this device enables all phases of the electrical circuit in which maintenance needs to be performed to be earthed ¹⁾. The earthing truck is available in two versions: for earth connection from the upper or lower terminals.

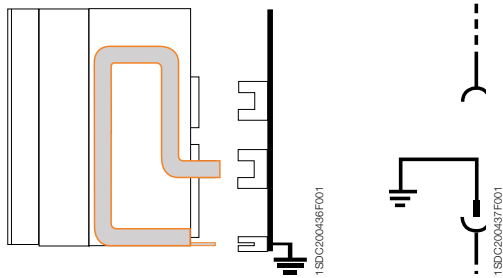

- **Earthing switch with making capacity MTP:** similar to the MT device, this differs due to the presence of a mechanical stored energy control which allows the circuit to be opened and closed. Two versions of this earthing switch are also available: for earth connection from the upper or lower terminals. It can also be accessorised with a keylock or padlocks for locking in the open position.

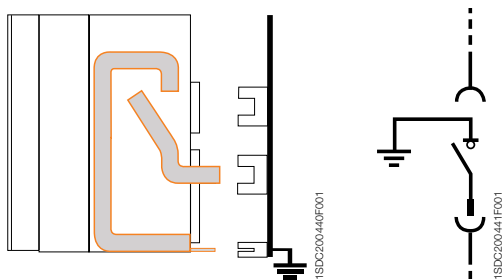
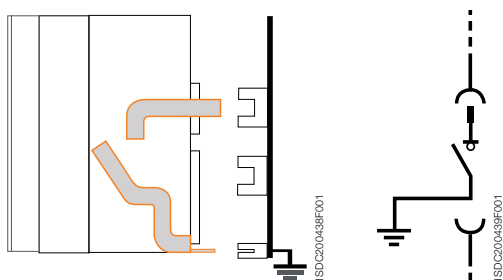

¹⁾ The earthing circuit is dimensioned for a short-time current equal to 60% of the maximum Icw of the circuit-breaker from which it is derived (IEC 60439-1)

Common data

Rated service voltage U _e	[V]	690
Rated insulation voltage U _i	[V]	1000
Rated impulse withstand voltage U _{imp}	[kV]	12
Frequency	[Hz]	50 - 60
Number of poles		3 - 4
Version		Withdrawable

SACE Emax 2	E2.2			E4.2			E6.2		
Performance levels	CS	MT	MTP	CS	MT	MTP	CS	MT	MTP
Rated uninterrupted current I _u @ 40°C	2500	2500	2500	4000	4000	4000	6300	6300	6300
Neutral pole current-carrying capacity for 4-pole CBs	100	100	100	100	100	100	50-100	50-100	50-100
Rated short-time withstand current I _{cw} (1s) [kA]	-	30	30	-	50	50	-	50	50

Other versions

Corrosive substances, vibrations, shocks or very low temperatures can be present in particular applications. In this regard, SACE Emax 2 circuit-breakers offer specific solutions developed precisely for:

- **Aggressive environments**, such as industrial processes for paper production, oil refining or water treatment, which are subject to high levels of sulphur dioxide (SO₂) and hydrogen sulphide (H₂S) contamination.
- **Antiseismic installations**, for areas with seismic risk where industrial and civil activities take place and where the continuity of critical processes must be guaranteed even in the case of particular natural events.

For further detail, please contact ABB SACE.

Protection trip units

Introduction	3/2
---------------------	------------

Architecture	3/4
---------------------	------------

Protection trip units for power distribution

Ekip Dip	3/6
Ekip Touch	3/10
Ekip Hi-Touch	3/20

Protection trip units for generators

Ekip G Touch	3/24
Ekip G Hi-Touch	3/29

Protection trip units for power control

Ekip Power Controller	3/32
-----------------------	------

Technical characteristics for protection trip units

Protection functions	3/38
Measurement functions	3/46

Protection trip units

Introduction

The SACE Emax 2 Ekip protection trip units are the new benchmark for the protection, measurement and control of low voltage electrical systems. The result of ABB SACE's experience and research, they make Emax 2 not only a circuit-breaker, but an actual Power Manager with all the functions necessary for optimal management of the system without the need for external devices.

3

The protection units are divided into two families: Ekip for distribution protection and Ekip G for generator protection. The range of trip units is available with three levels of performance, Dip, Touch and Hi-Touch, to satisfy simple to advanced applications. Exclusive functions such as the Ekip Power Controller and Network Analyzer complete the range, enabling power management and analysis of energy quality.

The complete, flexible Ekip protection trip unit offering, which can be adapted to the actual level of protection required, is shown below:

	Fields of applications	Measurement and Protection of Current	Measurement of Voltage, Power, Energy	Measurement and Protection of Voltage, Power, Energy	Network Analyzer	Power Control
Ekip Dip	Distribution	with Ekip Multimeter	–	–	–	–
Ekip Touch		•	with Ekip Measuring	with Ekip Measuring Pro	–	with Ekip Power Controller
Ekip Hi-Touch		•	•	•	•	
Ekip G Touch	Generators	•	•	•	–	with Ekip Power Controller
Ekip G Hi-Touch		•	•	•	•	



Ekip Power Controller function monitors installation loads and generators, permitting the power consumed to be limited and allowing savings on electricity bills.

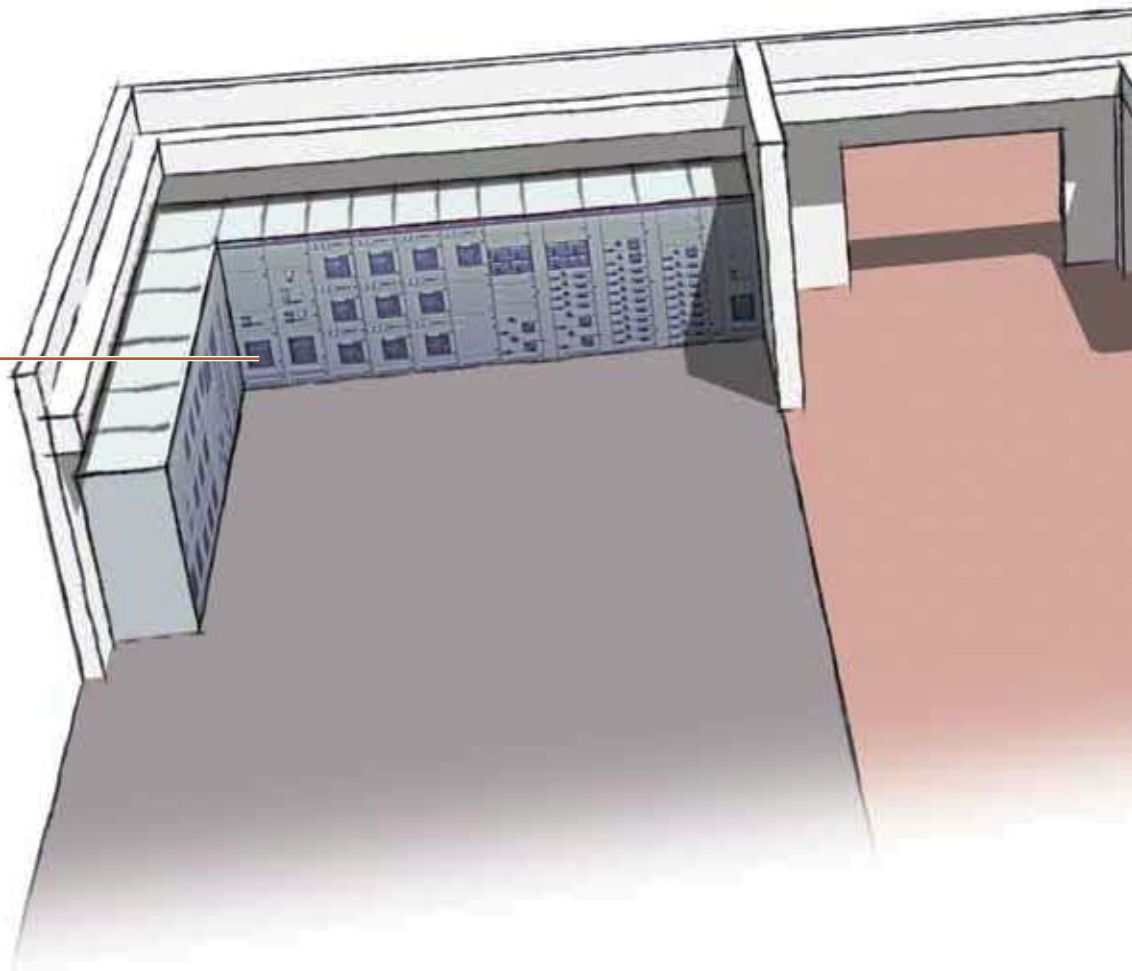

The **protection units for power distribution**, available in the LI, LSI and LSI-G versions, are suited to all distribution systems. The Ekip trip units are designed to protect a vast range of applications, such as use with transformers, motors and drives. Ekip Dip, Ekip Touch or Ekip Hi-Touch can be selected, depending on the complexity of the system, the need to take voltage or energy measurements or to include control systems in switchgear.

Ekip G enables the **protection of generators** without the use of external devices that require dedicated relays and wiring. Ekip G increases efficiency from the design stage to installation, minimizing the time needed for realization and commissioning of the system, and ensuring high levels of accuracy and reliability of all protection devices required for running generators in applications such as naval, GenSet or cogeneration.

Ekip Power Controller is the new function that controls the power absorbed, thereby increasing the efficiency of the system. This ABB SACE patented function measures power and energy but also controls, without the use of complex external automation logic, loads and generators in order to optimize the power consumed.

Thanks to the **Network Analyzer** function integrated in all Hi-Touch versions, the quality of energy in terms of harmonics, micro-interruptions or voltage dips is monitored without the need for dedicated instrumentation. This allows effective preventive and corrective action to be implemented through accurate analysis of the faults, thereby improving the efficiency of the system.

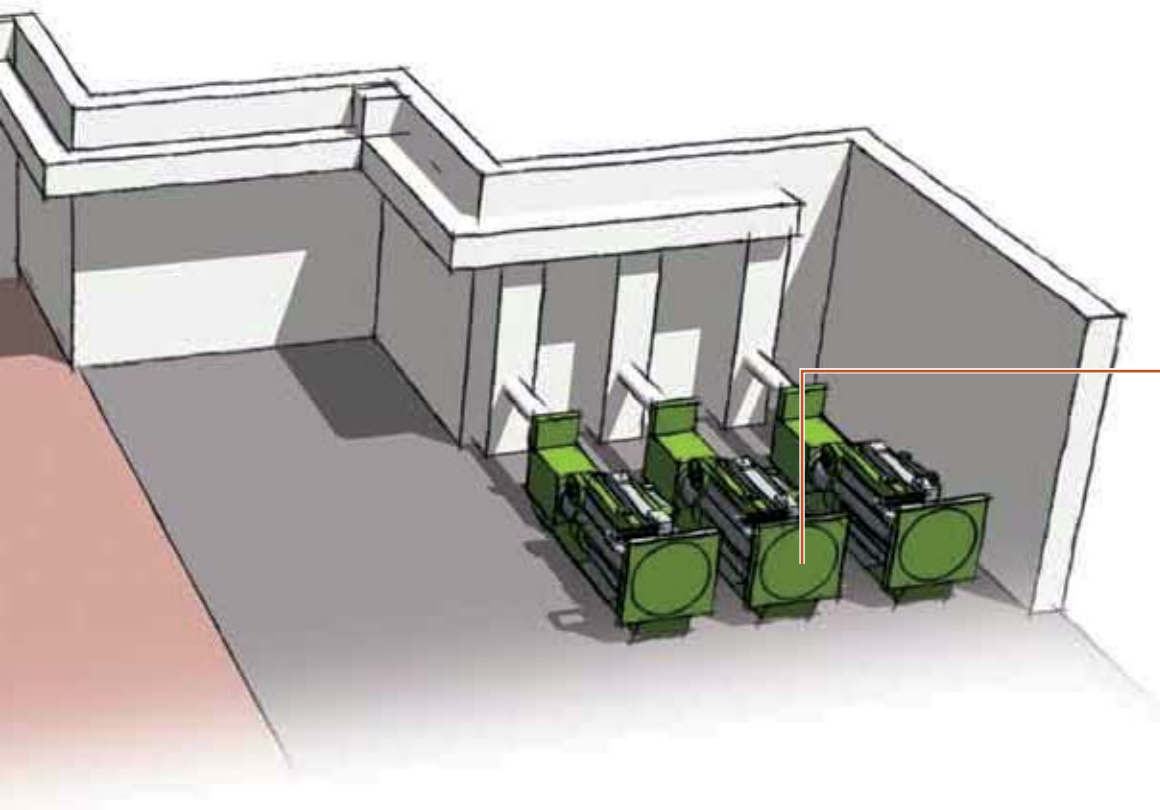

Ekip G enables the protection of generators without the use of external devices that require dedicated relays and wiring.

1SDC200442F001

Protection trip units

Architecture

All SACE Emax 2 circuit-breakers are equipped with protection trip units that are interchangeable from the front with just a few, simple operations by the customer. There is no need to dismantle the circuit-breaker or access any internal or sensitive parts.

3

This enables personalization of the functions available, even during commissioning or when the circuit-breaker has already been installed. In particular, SACE Ekip consists of:

- **Protection trip unit**, available with different interfaces and versions that range from basic to more complete; it contains a latest generation microprocessor that performs all the functions of protection and control.
- **Ekip Measuring Module**, connected internally to Emax 2, performs voltage, power and energy measurements with high accuracy without requiring any external connection or voltage transformer. The Ekip Measuring Pro version also performs all protection functions based on voltage and power without the need for external units, thereby simplifying design and construction of the system.
- **Interchangeable rating plug** enables all protection thresholds to be adjusted according to the rated current, increasing flexibility for the customer. It is useful in installations that are prepared for future development or in cases in which the power supplied may be limited temporarily.
- **Main board** is the mechanical housing of the trip unit, which includes a micro-controller for measuring currents and the self-protection functions. The separation of trip units ensures excellent reliability and immunity to conducted and radiated emissions. Integrated new generation Rogowski sensors, which are sensitive to the true r.m.s. value of the current, guarantee high accuracy of both measurements and protection.



All protection trip units of the SACE Emax 2 family are self-powered by current that crosses the circuit-breaker. They guarantee excellent reliability due to a system of self-control of internal connections. The setting, testing and downloading of reports can be carried out directly from a Smartphone, Tablet or PC.

In addition, the commissioning stage can be further accelerated, minimizing the possibility of errors, by directly configuring the protection trip unit with the DOC design software settings.

Cartridge-type modules that are easily installed on-board enable the units to be integrated into the most complex systems. Additional functions can be created, such as:

- **Synchrocheck**, to check the synchronization of the two half-busbars before enabling circuit-breaker closing;
- Communication with all **supervision systems** available in the Modbus, Profibus and DeviceNet protocols as well as the modern Modbus TCP, Profinet and EtherNet/IP protocols;
- **Integration into Smart Grids** thanks to the possibility of communicating without the assistance of any external converter, according to standards (IEC 61850) already in use in the automation systems of high and medium voltage substations;
- Multi-voltage **supply module**, which enables the protection trip unit and modules present to be supplied with any auxiliary voltage available in direct or alternating current;
- Programmable logic management with **Ekip Signalling** modules that make a high number of electrical input and output contacts;
- Logical interlocks between circuit-breakers, which can be made with the **Ekip Link** proprietary communication protocol, avoiding complex wiring thanks to the transmission of all signals via bus.



1SDC200445F001

Protection trip units for power distribution

Ekip Dip

Characteristics

Ekip Dip is the new protection trip unit of the SACE Emax 2 family for all applications in which high accuracy and reliable protection against overcurrent are required. Ekip Dip offers a complete set of standard protection functions. Dedicated LEDs allow the fault that caused tripping to be determined.

3

The unit is available in the following versions:

- Ekip Dip LI
- Ekip Dip LSI
- Ekip Dip LSIG

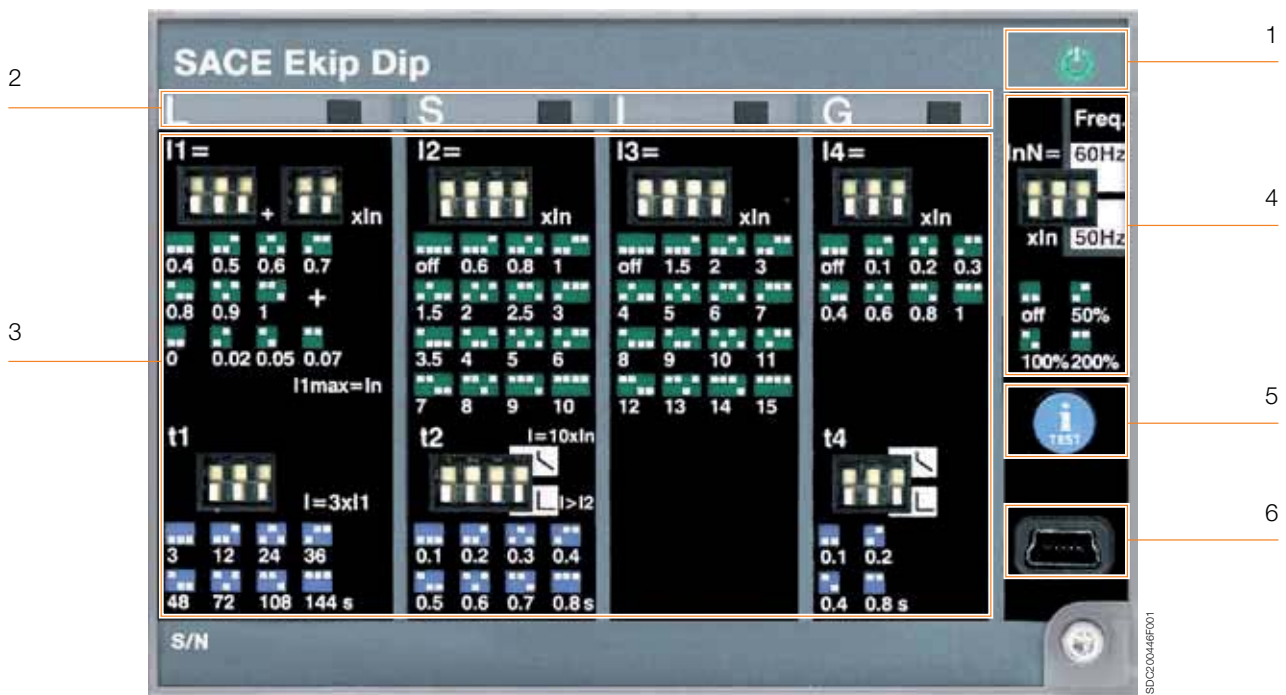

Key:

- | | |
|---|---|
| <ol style="list-style-type: none"> 1. Power-on LED for signalling correct operation (watchdog) 2. LEDs for alarm signalling of L, S, I and G protection functions and diagnostics 3. Dip switches for setting the protection functions | <ol style="list-style-type: none"> 4. Dip switches for setting the network frequency and neutral protection device 5. Pushbutton for test and for indicating the cause of tripping 6. Test and programming connector |
|---|---|

Protection functions

Ekip Dip offers overcurrent protection functions and, in the event of tripping, controls the opening of the circuit-breaker, preventing it from closing again unless it has been reset by the operator (lockout device – code ANSI 86).

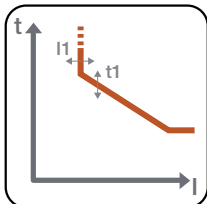

Overload (L - ANSI 49): with inverse long-time delay trip of the type $t = k/I^2$ available with 25 current thresholds and 8 curves, it provides effective protection of all systems. A pre-alarm warning is also available on reaching 90% of the threshold set.

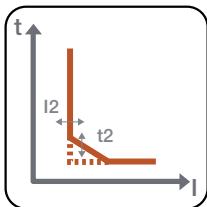

Time-delayed overcurrent (S - ANSI 51 & 50TD): with constant tripping time ($t = k$), or with constant specific let-through energy ($t = k/I^2$), it provides 15 current thresholds and 8 curves, for fine adjustment. The function can be excluded by setting the dip switch combination to “OFF”.

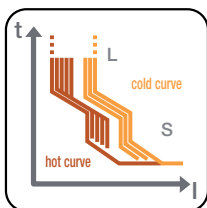

Thermal memory: for L and S protection functions, this is used to protect components, such as transformers, from overheating following an overload. The function, which can be enabled by the Ekip Connect software, adjusts the protection tripping time according to the length of time that has elapsed since the first overload, taking into account the amount of heat generated.

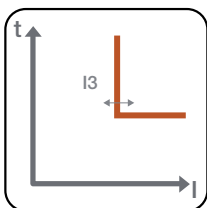

Instantaneous overcurrent (I - ANSI 50): with tripping curve without intentional delay, it offers 15 tripping thresholds and can be excluded by setting the dip switch combination to “OFF”.

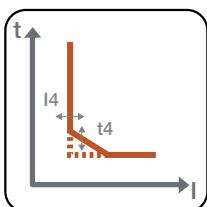

Earth fault (G - ANSI 51N & 50NTD): with tripping time independent of current ($t = k$) or constant specific let-through energy ($t = k/I^2$). The function can be excluded by setting the dip switch combination to “OFF”.

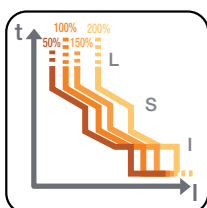

Neutral protection: available at 50%, 100% or 200% of the phase currents, or disabled, it is applied to the overcurrent protections L, S and I.

Protection trip units for power distribution

Ekip Dip

Measurements

The Ekip Dip unit measures phase and neutral current with great accuracy: 1% including the current transformers in the 0.2 ... 1.2 In range (class 1 in accordance with IEC 61557-12). Using the current sensors in the circuit-breaker and without the need to install an external measuring system, it is possible to view the measurements by the display on the front of the Ekip Multimeter and Ekip Control Panel.

Ekip Dip also records the characteristics of the circuit-breaker, to enable a rapid analysis in the event of maintenance:

- Maximum and average current values per phase;
- Date, time, fault current per phase and type of protection tripped over the last 30 trips;
- Date, time and type of operation of the last 200 events (for example: opening/closing of circuit-breaker, pre-alarms, editing settings);
- Number of mechanical and electric operations of the circuit-breaker;
- Total operating time;
- Contact wear;
- Date and time of the last maintenance carried out, in addition to the estimate of the next maintenance required;
- Circuit-breaker identifying data: type, serial number, firmware version, name of the device as assigned by the user.

The values can be displayed on the front of the Ekip Multimeter or Ekip Control Panel or by Ekip Connect software on a Smartphone, Tablet or PC by using the communication units Ekip T&P or Ekip Bluetooth.

Watchdog

All the protection trip units of the SACE Emax 2 family ensure high reliability owing to an electronic circuit that periodically controls the continuity of the internal connections, such as trip coil, rating plug and each current sensor (Ansi 74). In the event of a malfunction, the LEDs indicate the corresponding alarm to enable the fault to be identified rapidly. Furthermore, Ekip Dip detects and indicates that the circuit-breaker has been opened because one of the protection functions has been tripped (Ansi BF code). In order to preserve the correct operation of the unit, Ekip Dip is also provided with self-protection against abnormal temperature (OT) inside the protection trip unit. The user can set it to open the circuit-breaker or to merely indicate an alarm.

User interface

Ekip offers a great variety of thresholds and trip times, the protections can be set by dip-switches. Up to 5 LEDs are also available (depending on the version) to indicate correct operation or alarms. The interface always enables the status of the installation to be identified clearly and quickly:

- correct operation (green LED)
- overcurrent pre-alarms or alarms
- presence of self-control functions alarms
- maintenance interval expired
- indication of tripped protection after a fault

The protection tripped indication is activated by pressing the iTest key, and operates without the need of an external power supply because a battery is installed inside the unit.

Communication

The Ekip Bluetooth wireless communication unit enables the operator to interact with the protection trip unit by computer, Smartphone or Tablet. In fact, the free Ekip Connect software for Smartphones, Tablets and PC, enables measurements and fault data to be read and alarm status and information on the circuit-breaker or maintenance to be displayed. It is also possible to set parameters such as date, time and thermal memory and for the records to be reset.

Test function

The test port on the front of the protection trip unit can be used to run the circuit-breaker tests by connecting one of the following devices:

- Ekip TT to run the trip test, the LEDs test and check absence of alarms detected by the watchdog function;
- Ekip T&P to permit not only the trip test and LEDs test but also to run the test of the individual protection functions and save the relative report;
- ITest key that is pressed to run the battery test when the circuit-breaker is disconnected.

Supply

The Ekip Dip protection trip unit does not require an external supply for the protection functions or for the alarm indication functions because it is self-supplied by the current sensors installed on the circuit-breaker. A three-phase 100A current suffices to activate the LED indications.

The Ekip Supply module enables an auxiliary supply to be easily connected and is able to receive both a direct current supply (24-48V DC or 110-240V DC) and an alternating current (110-240V AC) to activate additional functions such as:

- G protection at values below 100A or below 0.2 In;
- connecting to external devices such as Ekip Multimeter and Ekip Control Panel;
- recording the number of operations.

The Ekip Dip protection trip unit also has a battery that enables the indication of the cause of the fault to be viewed for an unlimited time after tripping. In addition to that, the battery enables date and time to be maintained and updated, thus ensuring the chronology of the events. On the other hand, when the unit is switched off, the battery test can be run by simply pressing the iTest key.

Supply	Ekip Supply	
Nominal voltage	24-48V DC	110-240V AC/DC
Voltage range	21.5 - 53V DC	105-265V AC/DC
Rated power (including modules)	10W max.	10W max.
Inrush current	~10 A for 5 ms	~10 A for 5 ms

Whenever cartridge modules are not used in the terminal box area, the trip unit can be supplied by means of a galvanically isolated 24V DC auxiliary voltage.

Protection trip units for power distribution

Ekip Touch

Characteristics

Ekip Touch is the new protection trip unit for SACE Emax 2 that provides a complete series of protections and high accuracy measurements of all electric parameters and can be integrated perfectly with the most common automation and supervision systems.

3 The simple and intuitive interface enables the operator to access all the information and settings rapidly and easily by minimizing installation and commissioning time.

The unit is available in the versions:

- Ekip Touch LI
- Ekip Touch LSI
- Ekip Touch LSIG



Key:

- | | |
|--|---|
| 1. Wide high-resolution colour touchscreen display | 4. Alarm LED |
| 2. Power-on LED to indicate correct operation (watchdog) | 5. Home pushbutton to return to home page |
| 3. Pre-alarm LED | 6. Pushbutton for test and indicating cause of trip |
| | 7. Test and programming connector |

Protection functions

Ekip Touch enables all the protection functions to be set with a few simple steps directly from the wide touchscreen display. If the circuit breaker is tripped it must be reset manually or electrically by the operator (lockout relay – code ANSI 86).

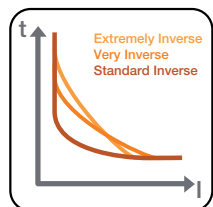

Overload (L - ANSI 49): available with three different types of trip curve:

1. $t = k/I^2$ with inverse long time;
2. IDMT in accordance with IEC 60255-3 for coordination with medium voltage protections, that are available according to the Standard Inverse (SI), Very Inverse (VI) and Extremely Inverse (EI) curves;
3. with $t = k/I^4$ curve for better coordination with upstream circuit-breakers or with fuses.

The thresholds can be fine tuned (for example 1A for circuit-breaker E1.2 1000A) and the timings to the second can be set directly from the display. The settable pre-alarm indicates the set threshold is reached before the protection is tripped. The protection can be disabled by rating plug L=off.

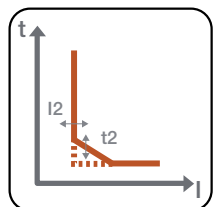

Time-delayed overcurrent (S - ANSI 51 & 50TD): with constant trip time ($t = k$), or constant specific let-through energy ($t = k/I^2$).

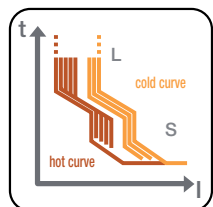

Thermal memory: for protections L and S it is used to protect the components, such as transformers, against overheating following overloads. The protection adjusts the trip time of the protection according to how much time has elapsed after the first overload, taking account of the overheating caused.

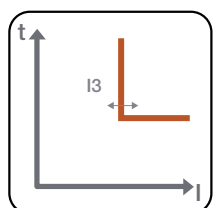

Instantaneous overcurrent (I - ANSI 50): with trip curve without intentional delay.

Closing on short-circuit (MCR): the protection uses the same algorithm of the protection I, limiting operation to a settable time window from the closing of the circuit-breaker. The protection can be disabled, also alternatively to protection I. The function is active with an auxiliary supply.

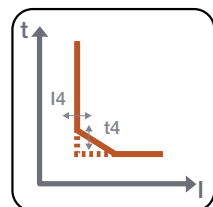

Earth fault (G - ANSI 51N & 50NTD): with trip time independent of the current ($t = k$) or with constant specific let-through energy ($t = k/I^2$). A pre-alarm indication is also available when 90% of the threshold is reached to activate corrective measures before the protection is tripped. The function also enables the trip to be excluded so that only the alarm is indicated, for use in installations where continuity of service is an essential requirement.

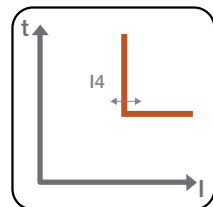

Instantaneous Earth Fault (G-ANSI 50N): with trip curve without instantaneous delay.

Protection trip units for power distribution

Ekip Touch

3

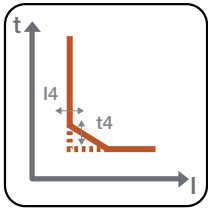

Earth fault on toroid (G ext - ANSI 51G & 50GTD): with trip time independent of the current ($t = k$) or with constant specific let-through energy ($t = k/I^2$). Pre-alarm that 90% threshold has been reached permit the fault to be reported to supervision systems without interruption of continuity. The protection uses the external toroid installed, for example, on the star centre of the transformer, and is an alternative to the G and Rc functions. The function is active with an auxiliary supply.

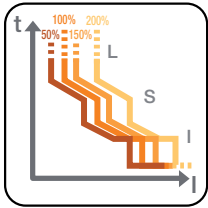

Neutral protection: available at 50%, 100%, 150% or 200% of the phase currents, or disabled, it is applied to the overcurrent protections L, S and I.

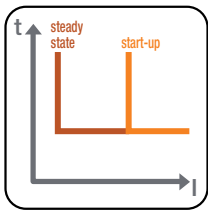

Start-up function: enables protections S, I and G to operate with higher trip thresholds during the starting phase, avoiding untimely trips due to high inrush currents of certain loads (motors, transformers, lamps). The starting phase lasts 100 ms to 30 s and is recognized automatically by the trip unit:

- at the closing of the circuit-breaker with a self-supplied trip unit;
- when the peak value of the maximum current exceeds the set threshold ($0.1 \dots 10 \times I_n$) with an externally supplied trip unit; a new start-up is possible after the current falls below the threshold.

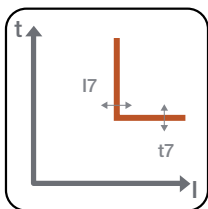

Current unbalance (IU – ANSI 46): with constant trip time ($t = k$), protects from an unbalance between the currents of the single phases protected by the circuit-breaker.

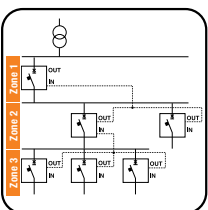

Zone selectivity for S and G protection (ANSI 68): can be used to minimize circuit-breaker trip times closer to the fault. The protection is provided by connecting all the zone selectivity outputs of the trip units belonging to the same zone and taking this signal to the trip unit input that is immediately upstream. Each circuit-breaker that detects a fault reports it to the circuit-breaker upstream; the circuit-breaker thus detects the fault but does not receive any communication from those downstream and opens without waiting for the set delay to elapse. It is possible to enable zone selectivity if the fixed-time curve has been selected and the auxiliary supply is present.

Current thresholds: this function enables the realization of four independent thresholds to be indicated in order to enable corrective action implementation before the overload L protection trips the circuit-breaker. For example, by disconnecting loads located downstream of the circuit-breaker that are controlled by Ekip Signalling.

Power Controller: Power controller function (optional) with Ekip Measuring module.

Protection functions with Ekip Measuring Pro



The Ekip Touch protection functions can be further increased by using the Ekip Measuring Pro measuring and protection module. With this module, all the protection functions linked to voltage, frequency and power can be enabled, thus making Ekip Touch a multifunction unit that can measure, control and protect even the most complex installation.

A different operating mode can be chosen for each protection function:

1. Active: protection enabled by opening of the circuit-breaker when the threshold is reached;
2. Only alarm: protection active, with only alarm indication when the threshold is reached;
3. Deactivated: protection disabled.

Furthermore, when the voltage and frequency protections are activated, they indicate an alarm status even when the circuit-breaker is open so that a fault can be identified before the circuit-breaker closes.

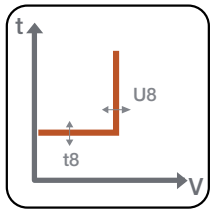

Undervoltage (UV - ANSI 27): with constant trip time ($t = k$), function is tripped when phase voltage falls below set threshold.

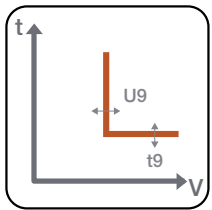

Overvoltage (OV - ANSI 59): with constant trip time ($t = k$), function is tripped when phase voltage exceeds the set threshold.

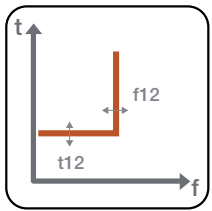

Underfrequency (UF - ANSI 81L): with constant trip time ($t = k$), function is tripped when network frequency falls below set threshold.

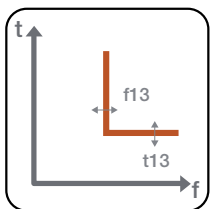

Overfrequency (OF - ANSI 81H): with constant trip time ($t = k$), function is tripped when network frequency exceeds the set threshold.

Protection trip units for power distribution

Ekip Touch

3

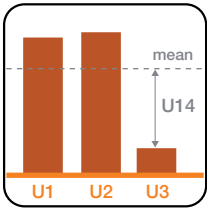

Voltage unbalance (VU – ANSI 47): with constant trip time ($t = k$), protects against an unbalance between the voltages of the individual phases that are protected by the circuit-breaker.

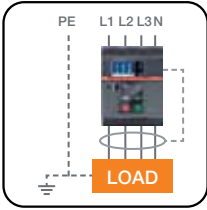

Residual current (Rc – ANSI 64 & 50NDT): with constant temperature ($t=k$) protects against indirect contacts and is integrated into Ekip Touch by a dedicated residual current rating plug and external toroid. The protection is an alternative to the functions G and Gext.

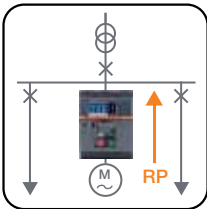

Reverse active power (RP - ANSI 32R): with constant trip time ($t = k$), function is tripped when total active power – in the opposite direction of the current - exceeds the set threshold.

In addition to the protection functions, the following indication and control functions are available to warn the user that a given condition has been reached. The active indications are always shown on the display and are also available by communication on the system bus (with Ekip Com modules) or electrical indication (with Ekip Signalling modules).

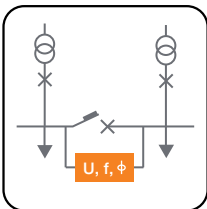

Synchrocheck (SC - ANSI 25): the synchronism control function compares the voltages in the module, the frequency and phase of the two circuits to which the circuit-breaker is connected. Ekip Touch indicates that conditions have been reached that enable the two lines to be made parallel. The function is available with two work modes:

- In systems with both busbars supplied, where synchronism is determined by:
 1. voltage of the two half-busbars above the U_{live} threshold for the set time
 2. difference of the module of the two voltages below the threshold ΔU
 3. difference of the frequency of the two voltages below the threshold Δf
 4. difference of the phase of the two voltages below the threshold $\Delta \Phi$
 5. desirable time for synchronism condition t_{syn}
 6. circuit-breaker open
- In systems with an out-of-service line (dead busbar), where the synchronism condition is determined by the concurrence of the following conditions for the t_{ref} set time:
 1. voltage of the active half-busbar above threshold U_{live}
 2. voltage of the dead half-busbar below threshold U_{dead}
 3. circuit-breaker open

In both cases, synchronism consent is withdrawn when one of the above conditions is missing and it has not been less than 200ms from the change of the circuit-breaker condition (when the relationship has been set). The indication of reached synchronism is available directly as an electrical indication via a contact that is always supplied with the module. The function can be activated simply by connecting the Ekip Synchrocheck module to any Ekip Touch provided with an Ekip Measuring Pro module.

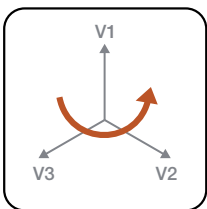

Cyclical direction of the phases (ANSI 47): indicates an alarm through inversion of the phases sequence.

Power factor (ANSI 78): available with a three-phase threshold, warns when the system operates with a power factor that is less than the set power factor.

Measurements



Measurements and meters

All versions of the Ekip Touch unit measure the RMS value of the currents of the three phases (L1, L2, L3) and of neutral (Ne) with 1% accuracy in the 0.2 to 1.2 In range (class 1 in accordance with IEC 61557-12). The complete range of measurement is from 0.03 to 16x In, where In is the value of the rating plug. The display shows the current of the most loaded phase both in numeric and analogue format on an ammeter with a 0-125% In scale for rapid identification of the load of the circuit-breaker.



Alternatively, bar graphs that show the currents of the three phases and of neutral on a 0-125% In scale in addition to the numeric value of the most loaded phase can be selected as the default page. The bar graphs are yellow in the event of a pre-alarm and red in the event of an overload to enable an irregular condition to be identified immediately.

Where applicable, the measurement of the earth fault current is shown on a dedicated page. The ammeter can operate both in self-supplied mode and with auxiliary voltage. In the latter case, the display always has back lighting and the ammeter is also active at currents below 100A.



Adding the Ekip Measuring or Ekip Measuring Pro module to Ekip Touch enables Ekip Touch to be used as a multimeter to measure the values of:

- Voltage: phase-phase, phase-neutral (accuracy 0.5%);
- Power: active, reactive, apparent (accuracy 2%);
- Energy: active, reactive, apparent (accuracy 2%);
- Frequency (accuracy 0.2%);
- Power factor by phase and total;
- Peak factor.

Maximum values and values register

The Ekip Touch unit is able to supply the measurement trend of certain parameters over a settable period of time such as: average power, maximum power, maximum and minimum current, maximum and minimum voltage. The values of the last 24 time intervals are recorded in the unit with a relative timestamp and can be consulted directly from the display or remotely using one of the available communication protocols. The communication can also be used to synchronize the recording time interval.

Data logger

Ekip Touch is always supplied with the exclusive Data Logger (register) function that stores with high sampling frequency the instantaneous values of all the measurements in two memory buffer registers. The data can be easily downloaded by the Ekip Connect unit and transferred to any personal computer. This enables the current and voltage waveforms to be analyzed for rapid fault analysis. The function continuously stores and stops recording, with a selectable delay, whenever the event set by the user occurs (e.g. trip or alarm). In this manner, it is possible to analyze the complete evolution of the fault: from the start to its complete elimination.

Protection trip units for power distribution

Ekip Touch

3

Information on trip and opening data

If a trip occurs, Ekip Touch stores all the information that is required for rapid identification and elimination of the causes:

- Protection tripped
- Opening data (current, voltage or frequency)
- Time-stamping (date, time and consecutive opening number)

If the iTest key is pressed, the trip unit displays all these data directly on the display. No auxiliary supply is required. The information is also available to the user with the circuit-breaker open or without current flow, due to the battery installed inside the unit.



Maintenance indicators

A complete set of information about the circuit-breaker and its operation is available for effective fault analysis and preventive scheduling of maintenance. All the information can be seen from the display or from a PC using a communication unit. In particular:

- Date, time, fault current by phase and type of protection tripped over the last 30 trips;
- Date, time and type of operation of the last 200 events (example: opening/closing of circuit-breaker, pre-alarms, editing of settings, ect.);
- Number of operations of the circuit-breaker: divided into mechanical operations (no current), electrical operations (with current) and protection function (trip);
- Contact wear estimated in function of the number and type of openings;
- Total operating time of the circuit-breaker with circulating current;
- Date and time of the last maintenance session, scheduling of the next maintenance session;
- Circuit-breaker identifying data: type, serial number, firmware version, device name assigned by the user.

All the information can be viewed directly from the display and from a Smartphone, Tablet (with Ekip Bluetooth) or PC using the front port of the trip unit or the system communication.

Watchdog

All of the trip units in the SACE Emax 2 family ensure high reliability because of an electronic circuit that periodically controls continuity of the internal connections, such as trip coil, rating plug and each current sensor (Ansi 74). In the event of an alarm, a message is shown on the display, and if it is set during the installation phase, the trip unit can command the opening of the circuit-breaker. If a protection function intervenes, Ekip Touch always checks that the circuit-breaker has been opened by auxiliary contacts that indicate the position of the main contacts. Otherwise, Ekip Touch indicates an alarm (ANSI BF code - Breaker Failure) to be used to command the opening of the circuit-breaker located upstream.

Ekip also contains self-protection that preserves the correct operation of the unit against abnormal temperatures (OT) inside the protection trip unit. The user disposes of the following indications or controls:

- "Warning" LED for temperature below -20 °C or above +70 °C, at which the trip unit operates correctly with the display switched off
- "Alarm" LED for temperature outside the operating range, at which the trip unit commands the opening of the circuit-breaker (if set during the configuration phase).

User interface



All Ekip Touch operations are simple and intuitive due to the wide graphic colour touchscreen display. For example, all the main information is listed on one page (settable by default), thus enabling the state of the installation to be identified rapidly: maximum current, maximum voltage, active, reactive, apparent power and energy. In addition, the use of Ekip Touch is further simplified by the possibility of scrolling through the menu and reading the alarms in one of the languages that can be set directly from the display: Italian, English, German, French, Spanish, Chinese, Russian, Turkish and Thai.

The home pushbutton enables you to return, at any moment, to the main page and the iTest key enables the information to be viewed after a circuit-breaker trip and test.

As in the previous generation of trip units, a password system is used to manage "Read" or "Edit" modes. The default password, 00001, can be edited by the user. The protection parameters (curve and trip thresholds) are settable in "Edit" mode whereas it is always possible to consult the information in "Read" mode.



On the front of the trip unit there are also two LEDs: a pre-alarm LED (square yellow LED) and an alarm LED (red triangular LED); a message on the display always accompanies the flashing of the LEDs for clear identification of the type of event. The list of all the alarms active at that moment can be viewed by simply touching the display on the white strip in the bottom left of the alarms zone.

Ekip Touch is also supplied with a front port that permits a temporary connection to devices for test, supply or communication (for example Ekip T&P).

Protection trip units for power distribution

Ekip Touch

Communication

Communication modules that can be installed inside the circuit-breaker enable Ekip Touch to be integrated into the most modern supervision systems with protocols:

- IEC 61850
- Modbus TCP
- Modbus RS-485
- Profibus
- Profinet
- DeviceNet
- EtherNet/IP

3

The integration into communication systems enables measurements, statuses and alarms to be programmed and viewed by remote functions. If the circuit-breaker has to be opened and closed remotely, the Ekip Com Actuator module can be installed in the circuit-breaker front, in the right-hand accessories chamber.

For each circuit-breaker, several communication modules with different protocols can be used simultaneously; for example, this enables the circuit-breaker to be connected to the Ekip link system to obtain local supervision from the front of the switchgear and to simultaneously integrate it into a communication network. In addition, for applications requiring very high reliability, up to two modules of the same protocol can be inserted by use of the redundant version that enables two different addresses to communicate on the same bus.

Test function

For circuit-breaker testing it is possible to use the test port and the iTest key positioned on the front of the protection trip unit. The available functions are:

- trip test, test of the display and of the LEDs and check of absence of alarms detected by the watchdog function using Ekip TT (always supplied with Ekip Touch);
- test of the single protection functions and saving of the report, in addition to the trip test and test of the display, using Ekip T&P;
- test of the battery with the circuit-breaker switched off by pressing the iTest key.

Supply

The Ekip Touch protection trip unit is self-supplied by the current sensors and does not require an external supply for the basic protection functions or for the alarm indication functions. All protection settings are stored in a non-volatile memory that maintains the information, even without a power supply. To activate the indication functions the ammeter and the display, a 100A three-phase current suffices.

An auxiliary supply can easily be connected. The Ekip Supply module can be connected to supplies of both direct current and alternating current to activate additional functions such as:

- using the unit with circuit-breaker open;
- using additional modules such as Ekip Signalling and Ekip Com;
- connection to external devices such as Ekip Multimeter and Ekip Control Panel;
- recording the number of operations;
- G protection with values below 100A or below 0.2 In;
- zone selectivity;
- Gext and MCR protection functions.

Supply	Ekip Supply	
Nominal voltage	24-48V DC	110-240V AC/DC
Voltage range	21.5-53V DC	105-265V AC/DC
Rated power (including modules)	10W max.	10W max.
Inrush current	~10 A for 5 ms	~10 A for 5 ms

The Ekip Supply module allows the cartridge modules to be used in the terminal box area. Otherwise, the trip unit can be supplied by means of a galvanically isolated 24V DC auxiliary voltage.

The Ekip Measuring Pro module can supply the Ekip Touch trip unit with line voltage above 85V. In addition, if the module is installed with voltage pick-ups on the supply side, the trip unit can be used even if the circuit-breaker is open.

The Ekip Touch protection trip unit is also supplied with a battery that enables the cause of the fault to be indicated after a trip, without a time limit. In addition, the battery enables date and time to be updated, thus ensuring the chronology of the events. When Ekip Touch is operating, it uses an internal control circuit to indicate automatically that the battery is flat. On the other hand, when the unit is switched off the battery test can be run by simply pressing the iTest key.

Protection trip units for power distribution

Ekip Hi-Touch

Characteristics

The Ekip Hi-Touch of SACE Emax 2 is a high-performance multifunction unit that is extraordinarily versatile and can be used in even the most complex installations. Ekip Hi-Touch, in fact, features exclusive functions such as: directional protection, restricted earth fault and dual setting of the protections. In addition, Ekip Hi-Touch is supplied with the exclusive Network Analyzer function that can monitor the quality of the power absorbed by the installation in accordance with existing standards.

Ekip Hi-Touch boasts all the features of Ekip Touch; as standard, it features the measuring and protection module Ekip Measuring Pro and can also be fitted, like Ekip Touch, with the additional features provided by the internal modules and by the external accessories.

The front interface of the unit, which is common to Ekip Touch, is extremely simply because of the touchscreen colour display; it is able to show measurements, bar graphs and sine curves of the different electrical values.

The unit is available in the versions:

- Ekip Hi-Touch LSI
- Ekip Hi-Touch LSI G

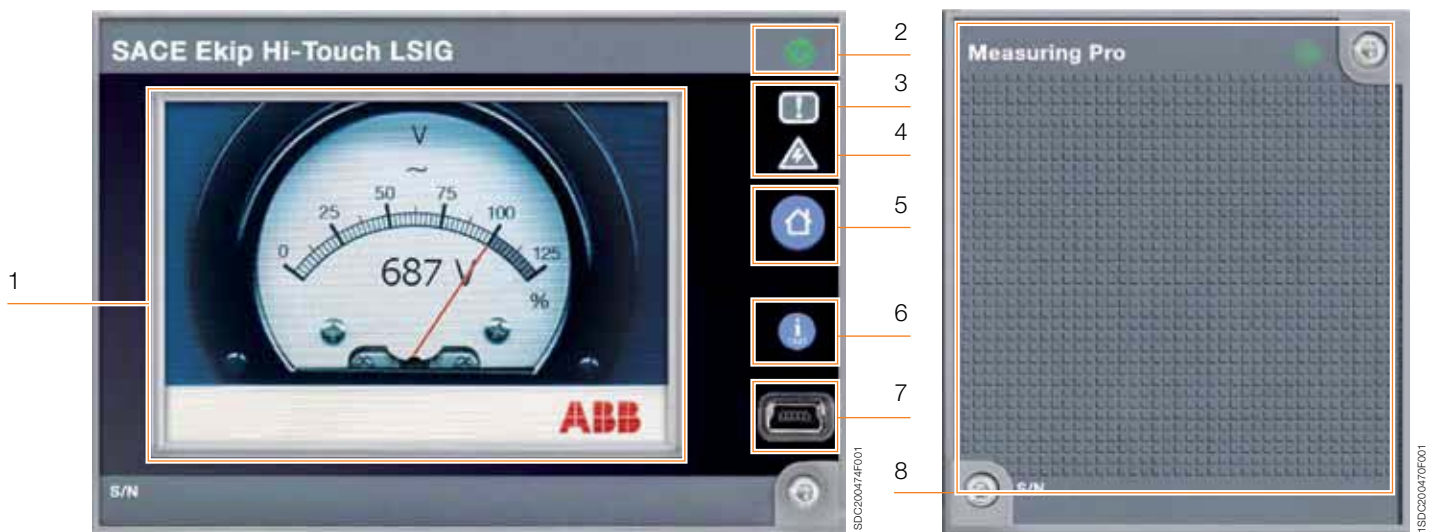

Key:

1. Wide high-resolution colour touchscreen display
2. Power-on LED indicating correct operation
3. Pre-alarm LED
4. Alarm LED
5. Home pushbutton to return to home page
6. Pushbutton for test and for indicating cause of the trip
7. Test and programming connector
8. Ekip Measuring Pro module, with relative LED power on

Protection functions

The Ekip Hi-Touch trip unit has the following protection functions, which it shares with Ekip Touch:

- Overload (L – ANSI 49);
- Time-delayed overcurrent (S – ANSI 51 & 50TD);
- Thermal memory;
- Instantaneous overcurrent (I – ANSI 50);
- Closing on short-circuit (MCR);
- Earth fault (G – ANSI 51N & 50NTD);
- Instantaneous Earth Fault (G – ANSI 50N);
- Earth fault on toroid (G ext – ANSI 51G & 50GTD)
- Neutral protection;
- Start-up function;
- Zone selectivity for functions S and G (ANSI 68);
- Current unbalance (IU – ANSI 46);
- Undervoltage (UV – ANSI 27);
- Overvoltage (OV – ANSI 59);
- Underfrequency (UF – ANSI 81L);
- Overfrequency (OF – ANSI 81H);
- Voltage unbalance (VU – ANSI 47);
- Residual current (Rc – ANSI 64 & 50NTD);
- Reverse active power (RP – ANSI 32R);
- Synchrocheck (SC – ANSI 25, optional);
- Cyclical direction of the phases (ANSI 47);
- Power factor (ANSI 78);
- Current thresholds;
- Power Controller function (optional).

The following protections are also available:

Second time-delayed overcurrent protection (S2 – ANSI 50TD): in addition to the standard protection S, a second (excludible) time-constant protection is available that enables two independent thresholds to be set in order to ensure precise selectivity, especially in highly critical conditions.

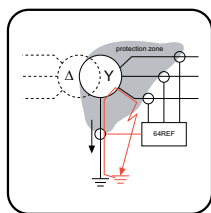

Second protection against earth fault (ANSI 50GTD/51G & 64REF): whereas with Ekip Touch the user has to choose between implementation of the protection G by internal current sensors (calculating the vector sum of the currents) or G ext external toroids (direct measurement of the earth fault current), Ekip Hi-Touch offers the exclusive feature of simultaneous management of both configurations by two independent earth fault protection curves. Owing to this characteristic, the trip unit is able to distinguish a non-restricted earth fault and then activate the opening of Emax 2, from a restricted earth fault, and to thus command the opening of the medium voltage circuit-breaker.

Another possible configuration is with the residual current protection replacing the Gext protection, whilst the G protection remains active. The residual current protection is activated in the presence of the residual current rating-plug and of the toroid.

Protection trip units for power distribution

Ekip Hi-Touch

3

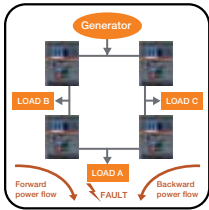

Directional overcurrent (D – ANSI 67): the protection is able to recognize the direction of the current during the fault period and thus detect if the fault is upstream or downstream of the circuit-breaker. The protection, with fixed time trip curve ($t=k$), intervenes with two different time delays (t_{7bw} and t_{7fw}), according to the current direction. In ring distribution systems, this enables the distribution portion to be identified in which the fault occurred and to disconnect it while maintaining the operation of the rest of the installation.

Zone selectivity for protection D (ANSI 68): enables the possibility to connect circuit-breakers among them, that in case of fault rapidly isolate the fault area, disconnecting the installation only at the level nearest to the fault, maintaining the operation of the rest of the installation. The function is particularly useful in ring and grid installations where, in addition to the zone, it is also essential to define the flow direction of the power that supplies the fault. It is possible to enable directional zone selectivity alternatively to the zone selectivity of the protections S and G, and in the presence of an auxiliary supply.

Start-up function for protection D: enables higher trip thresholds to be set at the outgoing point, as available for protections S, I and G.

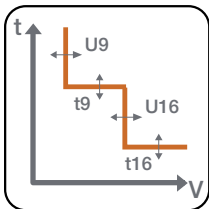

Second protection against undervoltage and overvoltage (UV2 and OV2 – ANSI 27 and 59): enables two minimum and maximum voltage thresholds to be set with different delays in order to be able to discriminate, for example, between voltage dip transients due to the start-up of a motor and an actual fault.

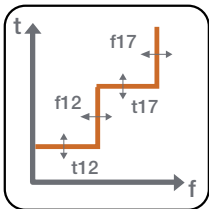

Second protection against underfrequency and overfrequency (UF2 and OF2 – ANSI 87L and 87H): enables two minimum and maximum frequency thresholds to be set simultaneously. For example, only an alarm can be set to be tripped when the first threshold is reached, and the circuit-breaker can be set to be opened when the second threshold is reached.

Dual setting of protections: Ekip Hi-Touch can store a set of alternative parameters for all protections. This second series (set B) can replace, if necessary, the default series (set A) by an external control. The control can be given when the network configuration is edited, for example when an emergency source is activated in the system, changing the load capacity and the short-circuit levels. Another typical application is protecting the operator opposite the switchgear against the electric arc. In this case, protection delays are minimized to safeguard the operator (Set A), whereas in the absence of an operator the protections are set to ensure selectivity with the circuit-breakers downstream (Set B). It is possible to activate series B by:

- Digital input available with an Ekip Signalling module;
- Communication network, by means of one of the Ekip Com communication modules;
- Directly from the Ekip Hi-Touch display;
- By a settable internal time, after the circuit-breaker has closed.

Measurements

The Ekip Hi-Touch trip unit offers a complete series of measurements, common to Ekip Touch:

- Measurements and counters: currents, voltage, power, energy;
- Maximum values and value log;
- Data logger;
- Information on the trip and opening data;
- Maintenance indicators.

Ekip Hi-Touch integrates the exclusive **Network Analyzer** function, which analyzes the quality of energy consumed by the installation, in accordance with the provisions of international standards EN50160 and IEC 61000-4-30, in terms of harmonic content, average value and long or short term changes in voltage. Changes in the quality energy can cause malfunctions in the switchgear and a reduction in their lifespan, as well as increasing losses and reducing the energy efficiency of the installation. It is therefore increasingly important to assess the quality of the energy and the economic impact it has on the productive process, so that the appropriate preventive and corrective actions can be taken. With Ekip Hi-Touch, the causes of an increase in power lost in transformers or motors, or a reduction in the lifespan of cables and capacitors, can be identified without the need to install any external instrumentation.

The Network Analyzer function performs continuous monitoring of the quality of energy, and shows all results through a display or communication module. In particular:

- **Hourly average voltage value:** in accordance with international standards, this must remain within 10% of the rated value, but different limits can be defined according to the needs of the installation. The positive sequence voltage is obtained from the three line voltages and compared with the limits. If the limits are exceeded, Ekip Hi-Touch generates a signalling event. The quantity of these events is stored in a suitable counter. The counter values are available for each of last 7 days, as well as the total. The measures available are the positive and negative sequence voltages and positive and negative sequence currents of the last interval monitored. The time of the calculation of the average values can be set between 5 minutes and 2 hours.
- **Interruptions / short dips in voltage** (voltage interruptions / voltage dip): if the voltage remains below the threshold for more than 40ms, Ekip Hi-Touch generates an event that is counted in a dedicated log. The voltage is monitored on all lines.
- **Short voltage spikes** (voltage transients, spikes): if the voltage exceeds the threshold for 40ms, set for a pre-determined time, Ekip Hi-Touch generates an event that is counted.
- **Slow voltage sags and swells** (voltage sag / voltage swell): when the voltage goes outside the range of acceptable limit values for a time greater than the one set, Ekip Hi-Touch generates an event that is counted. Three values can be configured for voltage sags and two for voltage swells, each of which associated to a time limit: this enables us to verify whether the voltage remains within a curve of values that are acceptable by equipment such as computers. The voltage is monitored on all lines.
- **Voltage unbalances:** if the voltages are not equal or the phase displacements between them are not exactly 120°, an unbalance occurs, which is manifested with a negative sequence voltage value. If this limit exceeds the threshold value set, an event is stored which is counted.
- **Harmonic analysis:** the harmonic content of voltages and currents, measured to the 50th harmonic, as well as the value of total harmonic distortion (THD), is available in real time on the display or through the communication modules. Ekip Hi-Touch also generates an alarm if the THD value or the magnitude of at least one of the harmonics exceeds the values set. The voltage is monitored on all lines and currents on all phases.

All information can be displayed directly on the screen or on a smartphone, tablet or PC using the front port of the trip unit (with Ekip Bluetooth) or installation communication.

Other functions

Ekip Hi-Touch integrates all the features in terms of user interface, communication, test and supply described for Ekip Touch equipped with Ekip Measuring Pro.

Protection trip units for generators

Ekip G Touch

Characteristics

Ekip G Touch by SACE Emax 2 is the new protection trip unit designed for use in applications with generators, such as Genset, cogeneration and marine applications, in conformity to international standards IEC 60034-1 and IEEE C37.102. Ekip G Touch has been approved by the main shipping registers and enables the number of components installed, such as external protection devices, current sensors, voltage transformers and the relative cabling, to be reduced. The reductions allow the installation to be significantly simplified. In addition, all the protection functions can be tested individually, using the Ekip T&P device that enables the function to be tested before commissioning.

The unit is available in the Ekip G Touch LSIG version and features all the characteristics provided by Ekip Touch. The Ekip Measuring Pro measuring and protection module is supplied as standard and, like Ekip Touch; the functions can be increased further using the internal modules and the external accessories.

The front interface of the unit, which is common to the Ekip Touch family, is characterised by a wide, high resolution touchscreen display that is simple to use and displays measurements and alarms clearly and accurately.

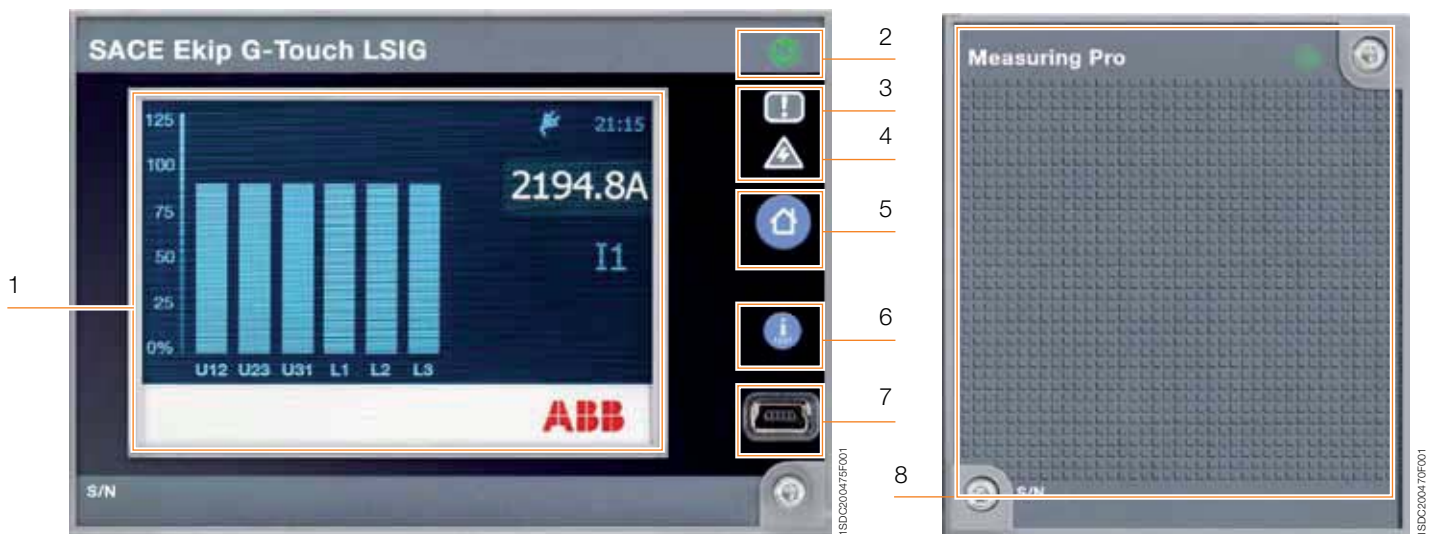

Key:

1. Wide, high resolution touchscreen display
2. Power-on LED indicating correct operation
3. Pre-alarm LED
4. Alarm LED
5. Home pushbutton to return to home page
6. Pushbutton for test and for indicating cause of the trip
7. Test and programming connector
8. Ekip Measuring Pro module with relative power-on LED

Protection functions

The Ekip G Touch trip unit provides all the protection functions of Ekip Touch and, in addition, provides a series of dedicated generator protections. If Ekip is tripped, it opens the circuit-breaker and prevents it from closing again until it has been reset manually or electrically by the operator (lockout relay – code ANSI 86).

The trip unit is provided with the following protection functions:

- Overload (L – ANSI 49);
- Time-delayed overcurrent (S – ANSI 51 & 50TD);
- Thermal memory;
- Instantaneous overcurrent (I – ANSI 50);
- Closing on short circuit (MCR);
- Earth fault (G – ANSI 51N & 50NTD);
- Instantaneous Earth Fault (G – ANSI 50N);
- Earth fault on toroid (G ext – ANSI 51G & 50GTD)
- Neutral protection;
- Start-up function;
- Zone selectivity for functions S and G (ANSI 68);
- Current unbalance (IU – ANSI 46);
- Undervoltage (UV – ANSI 27);
- Overvoltage (OV – ANSI 59);
- Underfrequency (UF – ANSI 81L);
- Overfrequency (OF – ANSI 81H);
- Voltage unbalance (VU – ANSI 47);
- Differential ground fault (Rc – ANSI 87N);
- Reverse active power (RP – ANSI 32R);
- Synchrocheck (SC – ANSI 25, optional);
- Cyclical direction of phases (ANSI 47);
- Power factor (ANSI 78);
- Current thresholds;
- Power Controller function (optional).

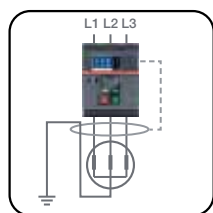

Differential ground fault (Rc - ANSI 87N): protects against internal earth fault on generator winding. It is required that the toroid hugs the active conductors and the ground conductor. Rc protection is integrated by a dedicated residual current rating plug and the external toroid.

Protection trip units for generators

Ekip G Touch

The specific functions for generator protections are described below, for each of which it is possible to choose the operating mode: active, only alarm or deactivated. All the voltage and frequency protections also operate when the circuit-breaker is open, enabling the fault to be identified before the closing of the circuit-breaker.

3

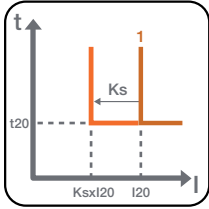

Voltage controlled overcurrent protection (S(V) - ANSI 51V): protection from maximum current with constant trip time ($t = k$) that is sensitive to the voltage value. The set current threshold, following a voltage drop, decreases by steps or linearly.

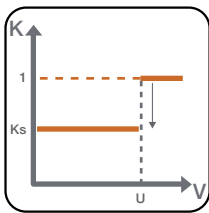

In step mode (controlled mode) the protection is tripped at the set threshold (I_{20}) if the voltage is above U , whereas it is tripped at the lower threshold of the factor K_s ($I_{20} * K_s$) if the voltage is below U .

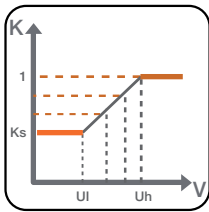

On the other hand, in linear mode (restrained mode) two voltage limits are selected within which the protection is tripped at the set threshold (I_{20}) reduced by the factor K corresponding to the measured voltage. The variation of the factor K is proportional to the voltage, and for voltages greater than the upper threshold (U_h) the threshold I_{20} works, whereas for voltages below the lower threshold (U_l) the minimum threshold ($I_{20} * K_s$) applies.

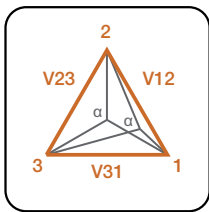

Residual overvoltage (RV - ANSI 59N): with constant trip time ($t = k$), protects against insulation loss in systems with insulated neutral or with neutral earthed with impedance.

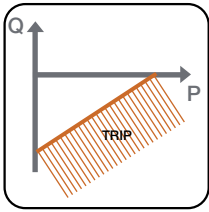

Loss of field or reverse reactive power (RQ – ANSI 40 or 32RQ): with constant trip time ($t = k$), is tripped when the total reactive power absorbed by the generator exceeds the set threshold. It is possible to select the constant threshold ($k=0$) or a function of the delivered active power of the generator ($k \neq 0$).

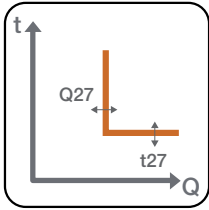

Reactive overpower (OQ – ANSI 32OF): with constant trip time ($t = k$), the function is tripped when reactive power exceeds the set threshold in the generator to network direction.

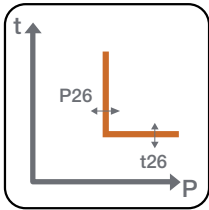

Active overpower (OP – ANSI 32OF): with constant trip time ($t = k$), the function is tripped when the active power exceeds the threshold set in the delivering direction of the generator.

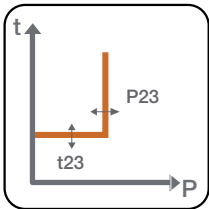

Active underpower (UP – ANSI 32LF): with constant trip time ($t = k$), the function is tripped when the active power delivered by the generator is lower than the set threshold. It is possible to disable the protection temporarily, to manage the start-up phase, by setting a time window from the closing of the circuit-breaker, by using an electric signal or via incoming communication to a relay.

Protection trip units for generators

Ekip G Touch

Measurements

The Ekip G Touch trip unit provides a complete series of measurements, which are common to Ekip Touch:

- Measurements and meters: currents, voltage, power, energy, frequency;
- Maximum values and values register;
- Data logger;
- Information on trip and opening data;
- Maintenance indicators.

3

All the information can be viewed directly from the display of the trip-unit, by means of the external Ekip Multimeter display or by Smartphone, Tablet or PC using the front port of the trip unit (with Ekip Bluetooth) or the system communications.

Other functions

Ekip G Touch provides the same characteristics in terms of user interface, communication, test and power supply described for Ekip Touch equipped with Ekip Measuring Pro.

Protection trip units for generators

Ekip G Hi-Touch

Characteristics

SACE Emax 2's Ekip G Hi-Touch is the new benchmark for the protection of low voltage electric generators. It provides optimum protection, even in complex installations, due to exclusive functions such as protection against frequency creep and maximum directional current.

Ekip G Hi-Touch, like all Hi-Touch trip units, is supplied as standard with the Ekip Measuring Pro measuring and protection module and enables an independent second set of protections to be set. In addition, the Network Analyzer function enables it to monitor the quality of the power delivered by the generator.

Ekip G Hi-Touch is available in the LSIG version and ensures all the protection, measuring and control functions of Ekip Hi-Touch and the specific protections for Ekip G Touch generators. The user interface and the accessories are common to the rest of the family.



Key:

1. Wide, high resolution touchscreen display
2. Power-on LED indicating correct operation
3. Pre-alarm LED
4. Alarm LED
5. Home pushbutton to return to home page
6. Pushbutton for test and for indicating cause of the trip
7. Test and programming connector
8. Ekip Measuring Pro module with relative power-on LED

Protection trip units for generators

Ekip G Hi-Touch

Protection functions

The Ekip G Hi-Touch trip unit is provided with the following protection functions, common to Ekip Hi-Touch:

- Overload (L – ANSI 49);
- Time-delayed overcurrent (S – ANSI 51 & 50TD);
- Time-delayed overcurrent, second threshold (S2 – ANSI 50TD);
- Thermal memory;
- Instantaneous overcurrent (I – ANSI 50);
- Directional overcurrent (D – ANSI 67);
- Voltage controlled overcurrent protection (S(V) – ANSI 51V);
- Closing on short circuit (MCR);
- Earth fault (G – ANSI 51N & 50NTD);
- Second protection against earth fault (ANSI 50GTD/51G & 64REF);
- Earth fault on toroid (Gext – ANSI 51G & 50GTD);
- Neutral protection;
- Start-up function;
- Zone selectivity for functions S and G (ANSI 68);
- Zone selectivity for directional protection D (ANSI 68)
- Start-up function for protection D;
- Current unbalance (IU – ANSI 46);
- Undervoltage (UV – ANSI 27);
- Undervoltage, second threshold (UV2 – ANSI 27);
- Overvoltage (OV – ANSI 59);
- Overvoltage, second threshold (OV2 – ANSI 59);
- Underfrequency (UF – ANSI 81L);
- Underfrequency, second threshold (UF2 – ANSI 81L);
- Overfrequency (OF – ANSI 81H);
- Overfrequency, second threshold (OF2 – ANSI 81H);
- Voltage unbalance (VU – ANSI 47);
- Residual overvoltage (RV – ANSI 59N);
- Differential ground fault (Rc – ANSI 87N);
- Loss of field or reverse reactive power (RQ – ANSI 40 or 32R);
- Reverse active power (RP – ANSI 32R);
- Reactive overpower (OQ – ANSI 32OF);
- Active overpower (OP – ANSI 32OF);
- Active underpower (UP - ANSI 32LF);
- Synchrocheck (SC – ANSI 25, optional);
- Cyclical direction of phases (ANSI 47);
- Power factor (ANSI 78);
- Current thresholds;
- Dual setting of protections;
- Power Controller function (optional).

In addition, the following protections are also available:

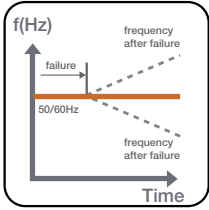

Rate of change of frequency (ROCOF – ANSI 81R): enables both positive and negative frequency variations to be detected rapidly. The protection is constant and is tripped when the frequency variation in Hz/s is greater than the set threshold.

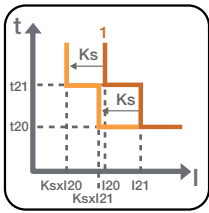

Second protection against voltage controlled overcurrent protection (S2(V) - ANSI 51V): available in addition to the protection S(V), enables total selectivity to be achieved in all installations.

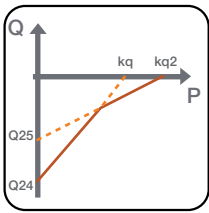

Second protection against loss of field or reverse reactive power (RQ – ANSI 40 or 32R): enables the generator’s de-energization curve to be followed very accurately, thereby avoiding any unnecessary disconnection.

Measurements

The Ekip G Hi-Touch trip unit provides all the measurements available with Ekip Hi-Touch:

- Network Analyzer, in conformity to EN50160 and IEC 61000-4-30;
- Measurements and meters: currents, voltage, power, energy, frequency;
- Maximum values and values register;
- Data logger;
- Information on trip and opening data;
- Maintenance indicators.

Other functions

Ekip G Hi-Touch has all the features of Ekip Touch equipped with Ekip Measuring Pro in terms of user interface, communication, test and power supply.

Protection trip units for power control

Ekip Power Controller

The exclusive Ekip Power Controller function, patented by ABB and available on new SACE Emax 2 circuit-breakers, monitors installation loads and generators, permitting the power consumed to be limited and allowing savings on electricity bills.

3

Ekip Power Controller, which can be used with all Ekip Touch trip units of the Emax 2 series, effectively helps to improve energy efficiency by managing the entire low voltage electrical system. It is, in fact, able to adapt the demand for power according to the availability of the energy source, the time of day and the costs indicated in the current pricing plan. In this way Ekip Power Controller is able to maintain power consumption within the limits defined, thereby optimizing the costs of managing the installation and reducing emissions.

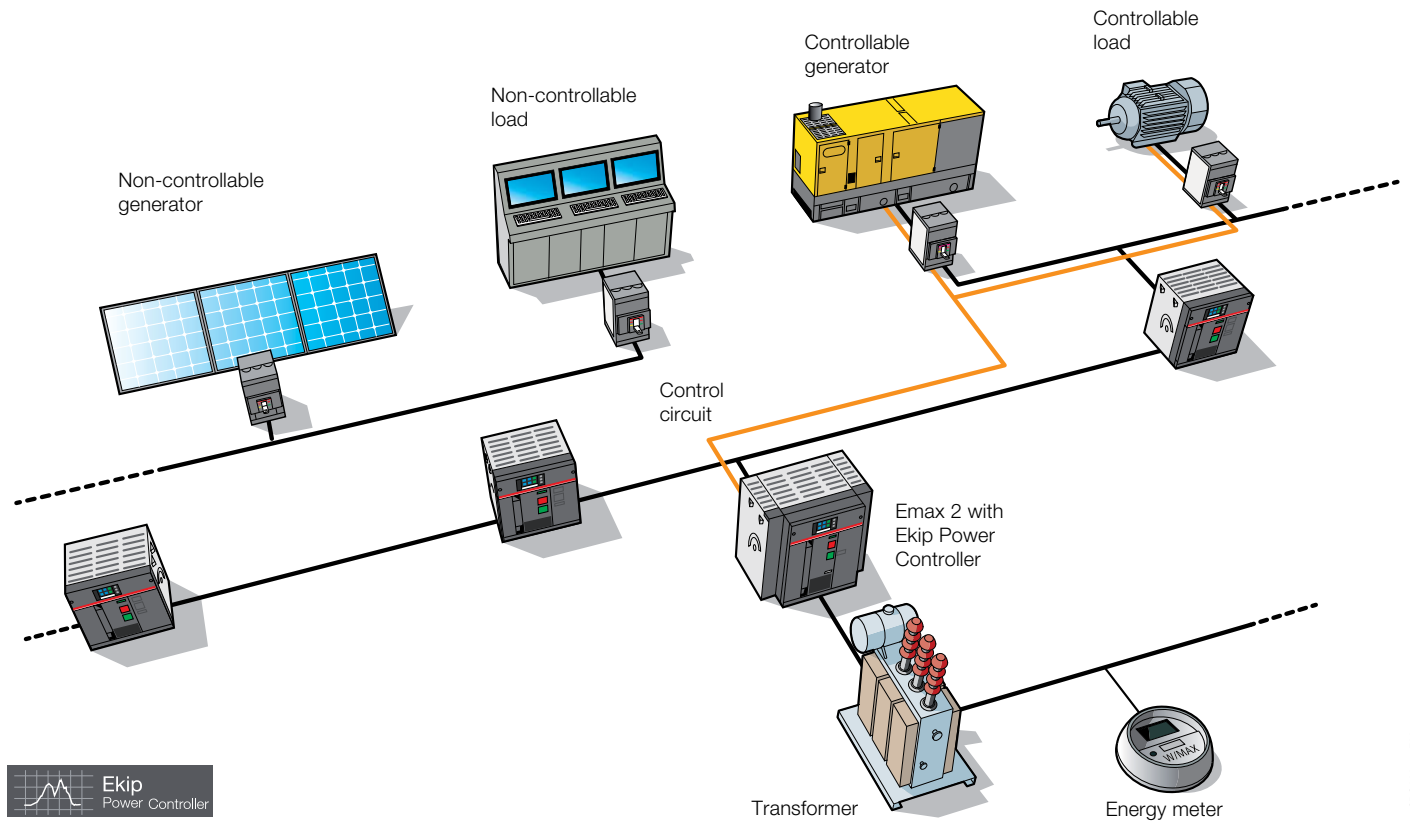

1SDC200477F001

Distinctive features

Reduction of energy costs with minimum impact. The loads are disconnected from the power supply for short periods, in the minimum number necessary and in a fixed order of priority, enabling power consumption peaks to be limited. This allows the contract drawn up with the energy provider to be renegotiated, reducing the power allocated, with a consequent reduction in total energy costs.

Power limited only when necessary. Ekip Power Controller manages up to four different time bands: it is therefore possible to respect a particular power limit according to whether it is during the day (peak) or night (off peak). In this way, consumption during the day when rates are at their highest can be limited.

Simple to install. Ekip Power Controller allows the installation to be managed efficiently with a simple architecture. Thanks to a patented design, it is sufficient to measure the total power of the installation without having to measure the power consumed by each load. Installation costs and times are thereby reduced to a minimum.

Ready to use. Ekip Power Controller does not require the writing, implementation and testing of complicated programmes for PLC or computer because the logic has already been implemented in the protection unit and is ready to use; it is sufficient to set the installation parameters from a smartphone or directly from the circuit-breaker display.

Improvement of the efficiency of the electrical system. Ekip Power Controller significantly helps to flatten the load curve, limiting the use of peaking power plants in favour of base load power plants with greater efficiency.

Graph of daily load

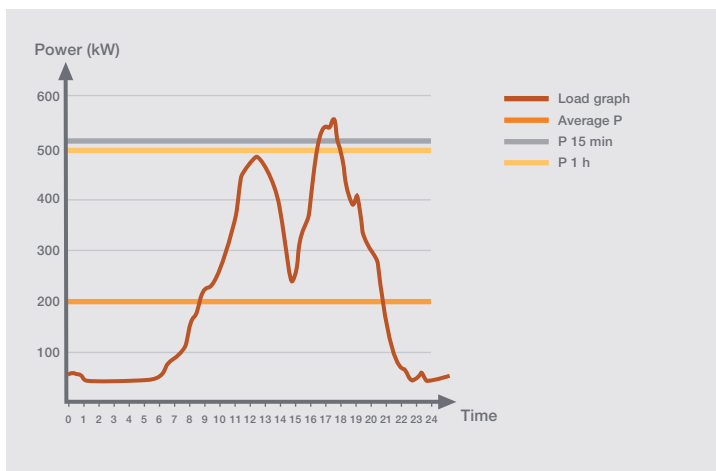

Perfect integration into intelligent networks. Thanks to integrated communication modules, Ekip Power Controller can receive the maximum absorbable power directly from the medium voltage control system, determining consumption for the next 15 minutes. Ekip Power Controller, according to the information received, manages the switching off of non-priority loads or the switching on of reserve generators. Ekip Power Controller gives maximum priority to non-programmable preferred energy sources, such as wind and solar, and they are therefore considered uninterruptable. In the event the production of internal power to the controlled network is reduced, due, for example, to decreased production of solar power, Ekip Power Controller will disconnect the necessary loads to respect the consumption limit set.

Perfect integration in self-generation systems. This benefit is used, for example, in installations with a system of cogeneration. Ekip Power Controller controls the total consumption drawn from the electrical network, interrupting non-indispensable loads when production is reduced and reconnecting them when generator power is sufficient to not exceed limits. There are multiple advantages: reduction in energy costs, maximum use of local production and greater overall energy efficiency.

Protection trip units for power control

Ekip Power Controller

Operating principle

Ekip Power Controller is an advanced system of control in real time that limits the average power consumed in each time range to a maximum, pre-determined value. This is achieved by delaying, only when necessary, the operation of controllable loads, which are then put back into operation as soon as possible without exceeding the limits of power set. In each instance, Ekip Power Controller optimizes the number of deactivated loads on the basis of a determined order of priority, constantly seeking to supply the most extensive part possible of the installation. If controllable generators are present such as, for example, diesel generators, Ekip Power Controller controls their switching on and off to limit the peak of power consumed. The types of loads that can be interrupted for a few minutes with a limited impact are many and vary according to the application, for example:

- industrial ovens, fridges;
- ventilation or air compression systems;
- electric car charging systems;
- electrical air conditioning/heating of corridors, stairways and passageways;
- electric kitchens in hotels/hospitals;
- swimming pool heating systems and circulation pumps.

The method of calculation

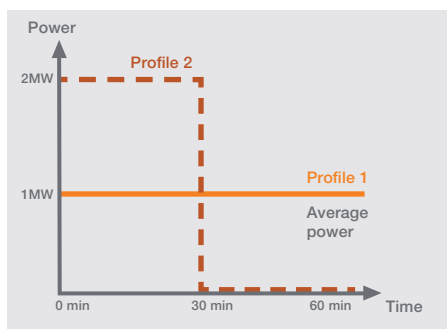

Ekip Power Controller controls the maximum power consumed by the installation, utilizing the same method as that used for fiscal metering, thereby achieving savings on the component connected to maximum power (\$/kW) on electricity bills. The power consumed is calculated by the energy meter as an average value over pre-determined time periods such as, for example, 15 minutes, or even 1 hour. The user therefore pays the same bill both in the event he consumes 1MW continuously (profile 1) or 2MW for 50% of the time and 0MW for the remaining 50% (profile 2), since the average power is the same.

Estimation of consumption

Ekip Power Controller uses this principle together with a predictive algorithm that estimates, moment by moment, power at the end of the period in order to decide whether to disconnect or connect loads and generators. This enables brief transient requests for high power to be tolerated, such as, for example, the starting up of motors, without causing the disconnection of loads as soon as the power exceeds the threshold set.

The operations of connection and disconnection therefore depend on the consumption from the beginning of the period up to the present moment: for example, if during the first few minutes of the period of reference consumption was very high, Ekip Power Controller will disconnect a greater number of loads in the minutes after; if, on the other hand, the initial consumption was low, it will leave a greater number of loads in operation.

Management of loads

According to the consumption estimate at the end of the period, Ekip Power Controller will take different actions:

- if the value estimated is greater than the power set as a target, Ekip Power Controller makes the decision to disconnect one of the loads controlled from the power supply, or to connect a generator;
- if the value estimated is equal or slightly less than the average power set as a target, Ekip Power Controller makes the decision to leave the conditions of the controlled loads and generators unchanged;
- if the value estimated is significantly lower than the average power set as a target, Ekip Power Controller makes the decision to reconnect one of the loads controlled to the power supply, or switch off a generator if one or more of these have been switched on previously.

This operation is carried out cyclically each time by calculating a new estimate: therefore, if the estimate of power consumed continues to be too high despite the fact that a load has been disconnected, Ekip Power Controller will proceed to disconnect another and so on, until the power limit is respected. In this way, the number of connected or disconnected loads varies dynamically, and always with the guarantee that only the minimum number needed to respect the power limit are disconnected.

Priority of loads

If the decision made is to disconnect or re-connect one of the loads controlled, Ekip Power Controller proceeds according to an established order: the load indicated as the first will be that of least importance, or that for which a temporary period of deactivation is acceptable; the load indicated as the second will be the next one in order of importance, and so on. The loads that have been disconnected in that order will be later re-connected in the reverse order, beginning with the load that is most important for the installation. In this way, the impact on the production process can be minimized, limiting the disconnection time for loads of the highest priority. Furthermore, by gradually connecting and disconnecting the loads in order of priority, voltage imbalances and consumption peaks affecting the network are avoided.

Protection of the installation

Ekip Power Controller can be integrated perfectly into the installation's protection devices. In fact, if one of the controlled circuit-breakers opens due to an overcurrent or by manual operation, Ekip Power Controller considers the load unavailable until the operator resets it, making it available again. In this way, safe operation of the installation is always guaranteed.

Protection trip units for power control

Ekip Power Controller

Architecture

Ekip Power Controller is installed on the main low voltage circuit-breaker, immediately downstream of the transformer and energy meter. By using the high precision current and voltage sensors located inside the SACE Emax 2, it is able to measure the average power consumed by the installation, using the same method as that used for fiscal metering, over an established time period. To control this average power, Ekip Power Controller performs controlled opening and closing of the switching devices.

A Power Controller system consists of:

- a SACE Emax 2 circuit-breaker with Ekip Touch protection trip unit equipped with Ekip Power Controller and Ekip Measuring. This circuit-breaker is the power controller and meter and implements the Power Controller function, determining the connection and disconnection of loads;
- up to 15 controlled loads and/or generators. The connection between Ekip Power Controller and users can be achieved:
 - with Ekip Signalling modules for connections inside the same switchboard. This allows circuit-breakers or contactors installed on the power circuit to be commanded directly through available outputs. The opening and closing operations are always carried out in safety due to an input that receives feedback on the state of the device.
 - with Ekip Signalling modules by acting on the generator starting circuit or on the control circuit of the loads. This allows, for example, the consumption of motors powered by drives to be reduced without interrupting the production cycle.
 - with Ekip Link communication modules for installations with circuit-breakers in different switchboards. This enables wiring between switchboards to be simplified to the use of only one EtherNet cable.

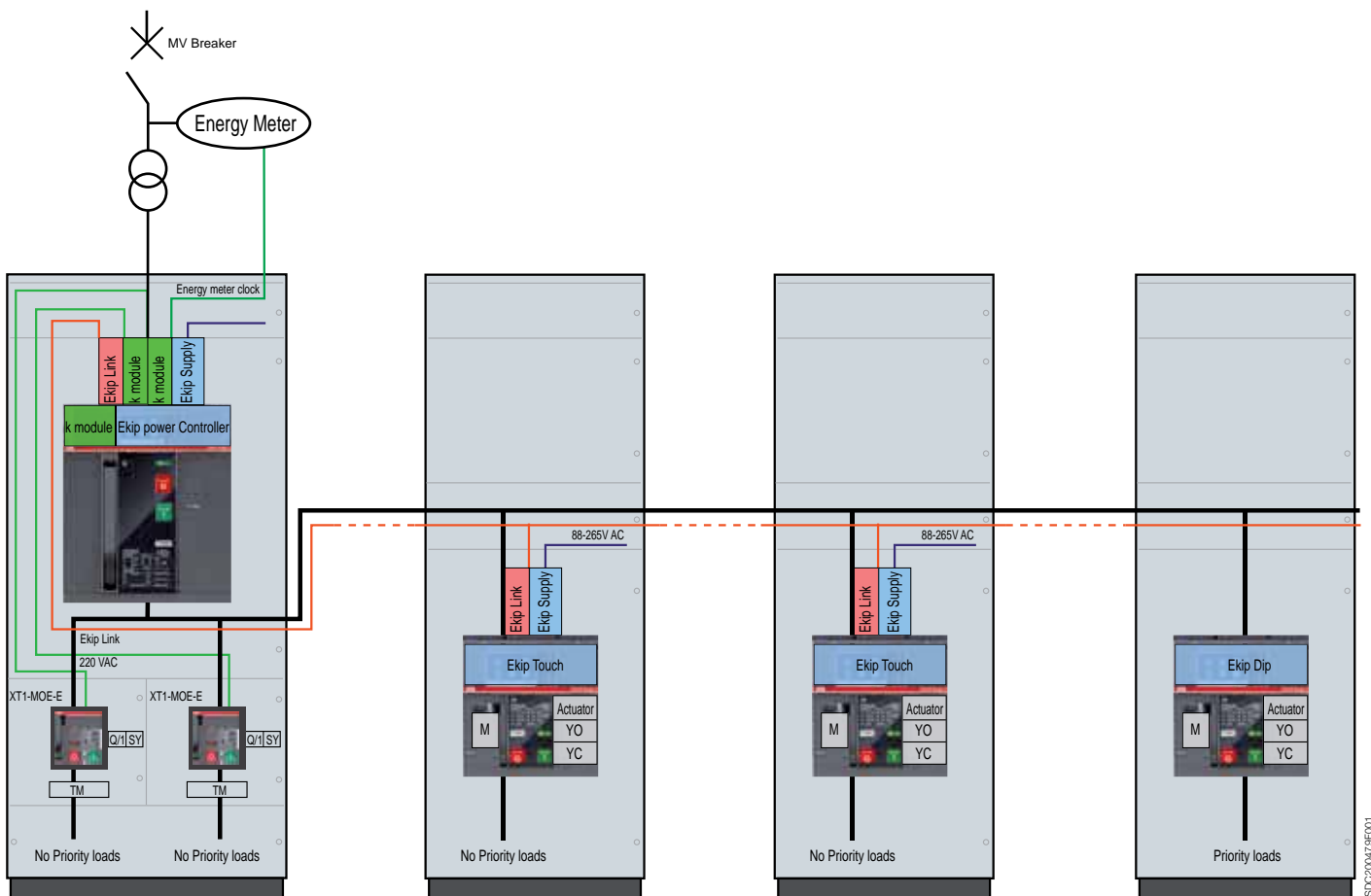

In the event that the installation is constructed with a single medium voltage delivery point and two or more transformers in parallel, Ekip Power Controller can acquire, via Ekip Link, the power measurement carried out by the other Emax 2 devices present. In this way the power limit can be respected at the medium voltage measuring point, without having to duplicate the control circuit of the loads.

Installation

Ekip Power Controller is not only simple to implement and use, it is also very flexible because of parameters which have been specially developed to satisfy the needs of all applications.

Installation parameters:

- Power limit: this is the average power that Ekip Power Controller respects, which can be selected in kW directly from the display.
- Evaluation window: this is the period in which the distributor of electrical energy evaluates the maximum power, which can be selected within a wide range to respect the local needs of each country.
- Synchronization input: this is used to synchronize the clock inside Ekip with that of the meter. It can also be used to signal a change in band.

Parameters of the user:

- Type of user: can be selected from among load and generator.
- Minimum disconnection time (T off min): this is the minimum time for which a load or generator is not supplied with power following disconnection. This is useful when you wish to avoid frequent operations on users that are at the top of the priority list. Ekip Power Controller reconnects the load or generator only after the time set has passed.
- Maximum disconnection time (T off max): this is the maximum time for which no power is permitted. It is required, for example, in the case of an oven to keep the temperature within the established limits. When the time has passed, Ekip Power Controller reactivates it automatically, disconnecting, if necessary, a load of a higher priority.
- Minimum connection time (T on min): minimum time for which a load or generator is kept powered following reconnection. It is useful in the event the generator has a minimum time for which it must remain connected. Until the time set has passed, Ekip Power Controller will not disconnect the load, connecting, if necessary, loads of a higher priority.
- Time window: this is the hours in the day when a load or generator can be operated. It is useful, for example, in the case of a canteen that cannot be disconnected during meal times, or a diesel generator that can not be operated at night due to noise pollution.
- Temporary unavailability: a user can be temporarily deactivated, for example, because it is undergoing maintenance, through the circuit-breaker display or digital input connected to a manual/automatic selector. The digital input can also be used, for example, in the case of a fridge, to manage its interruptability: with active input the fridge cannot be disconnected as it is above the minimum temperature, with inactive input, on the other hand, it can be disconnected.

Power limit	can be set directly in kW
Time bands	up to 4
Synchronization with contactor	•
Evaluation time	5...120 min
Number of loads/generators	up to 15
Priority	from 1 to 15
t on min	1...360 min
t off min	1...360 min
t off max	1...360 min
Temporary disabling input	1 for each device
Controllable devices	load/generator
Type of control	- moulded-case and air circuit-breaker - modular circuit-breakers - contactors - control circuit of load/generator
Type of connections	- wired - with Ekip Link communication for ACB

Technical characteristics for protection trip units

Protection functions

3

ABB Code	ANSI/IEEE C37.2 Code	Function	Threshold
L	49	Overload protection	I1 = 0.4 - 0.42 - 0.45 - 0.47 - 0.5 - 0.52 - 0.55 - 0.57 - 0.6 - 0.62 - 0.65 - 0.67 - 0.7 - 0.72 - 0.75 - 0.77 - 0.8 - 0.82 - 0.85 - 0.87 - 0.9 - 0.92 - 0.95 - 0.97 - 1 x In
		Thermal memory	
		Tolerance	tripping between 1.05 and 1.2 x I1
S	51	Short-circuit selective protection	I2 = 0.6 - 0.8 - 1 - 1.5 - 2 - 2.5 - 3 - 3.5 - 4 - 5 - 6 - 7 - 8 - 9 - 10 x In
		Tolerance	± 7% If ≤ 6 x In ± 10% If > 6 x In
		Short-circuit selective protection	I2 = 0.6 - 0.8 - 1 - 1.5 - 2 - 2.5 - 3 - 3.5 - 4 - 5 - 6 - 7 - 8 - 9 - 10 x In
		Thermal memory	
I	50	Short-circuit instantaneous protection	I3 = 1.5 - 2 - 3 - 4 - 5 - 6 - 7 - 8 - 9 - 10 - 11 - 12 - 13 - 14 - 15 x In
		Tolerance	± 10%
G	51N	Earth fault protection	I4 ⁽¹⁾ = 0.1 - 0.2 - 0.3 - 0.4 - 0.6 - 0.8 - 1 x In
		Tolerance	± 7%
		Earth fault protection	I4 ⁽¹⁾ = 0.1 - 0.2 - 0.3 - 0.4 - 0.6 - 0.8 - 1 x In
		Tolerance	± 7%

(1) G protection below 100A or below 0.2 In available with auxiliary supply

(2) The minimum trip time is 1s, regardless of the type of curve set (self-protection)

The tolerances above apply to trip units already powered by the main circuit with current flowing in at least two-phases or an auxiliary power supply. In all other cases the following tolerance values apply

ABB Code	Trip threshold	Trip time
L	Trip between 1.05 and 1.2 x I1	± 20%
S	± 10%	± 20%
I	± 15%	≤ 60ms
G	± 15%	± 20%



Trip time	Excludibility	Pre Alarm	Trip curve	Ekip Dip
with I = 3 I _n , t ₁ = 3 - 12 - 24 - 36 - 48 - 72 - 108 - 144 s ⁽²⁾	No	50 ... 90 I ₁ Step 1%	t = k / I ²	●
	Yes			●
± 10% If ≤ 6 x I _n ± 20% If > 6 x I _n				
t ₂ = 0.1 - 0.2 - 0.3 - 0.4 - 0.5 - 0.6 - 0.7 - 0.8s	Yes	No	t = k	●
The better of the two data: ± 10% or ± 40 ms				
with I = 10 I _n , t ₂ = 0.1 - 0.2 - 0.3 - 0.4 - 0.5 - 0.6 - 0.7 - 0.8s	Yes	No	t = k / I ²	●
	Yes	No		
± 15% If ≤ 6 x I _n ± 20% If > 6 x I _n				
Instantaneous ≤ 30 ms	Yes	No	t = k	●
t ₄ = 0.1 - 0.2 - 0.4 - 0.8s	Yes	No	t = k	●
The better of the two data: ± 10% or ± 40 ms				
t ₄ = 0.1 - 0.2 - 0.4 - 0.8s	Yes	No	t = k / I ²	●
± 15%				

Technical characteristics for protection trip units

Protection functions

3

ABB Code	ANSI Code	Function	Threshold	Threshold step	Tripping time	Time Step
L	49	Overload Protection	$I1 = 0.4 \dots 1 \times I_n$	$0.001 \times I_n$	with $I = 3 I1$, $t1 = 3 \dots 144 \text{ s}$	1s
		Thermal Memory Tolerance	tripping between 1.05 and $1.2 \times I1$		$\pm 10\% I \leq 6 \times I_n$ $\pm 20\% I > 6 \times I_n$	
	49	Overload Protection	$I1 = 0.4 \dots 1 \times I_n$	$0.001 \times I_n$	with $I = 3 I1$, $t1 = 3 \dots 144 \text{ s}$ Standard inverse SI: $k=0.14 \alpha=0,02$ Very Inverse VI: $k=13.5 \alpha=1$ Extremely Inverse EI: $k=80 \alpha=2$ $t=k/14$: $k=80 \alpha=4$	1s
		Thermal Memory Tolerance	tripping between 1.05 and $1.2 \times I1$		$\pm 10\% I \leq 6 \times I_n$ $\pm 20\% I > 6 \times I_n$	
S	50TD	Time-delayed overcurrent protection	$I2 = 0.6 \dots 10 \times I_n$	$0.1 \times I_n$	$t2 = 0.05 \dots 0.8 \text{ s}$	0.01s
	68	Zone selectivity			$t2\text{sel} = 0.04 \dots 0.2 \text{ s}$	0.01s
		Start up Tolerance	Activation: $0.6 \dots 10 \times I_n$ $\pm 7\% I \leq 6 \times I_n$ $\pm 10\% I > 6 \times I_n$	$0.1 \times I_n$	Range: $0.1 \dots 30 \text{ s}$ The better of the two data: $\pm 10\%$ or $\pm 40 \text{ ms}$	0.01s
	51	Time-delayed overcurrent protection	$I2 = 0.6 \dots 10 \times I_n$	$0.1 \times I_n$	with $I = 10 I_n$, $t2 = 0.05 \dots 0.8 \text{ s}$	0.01s
Thermal Memory Tolerance		$\pm 7\% I \leq 6 \times I_n$ $\pm 10\% I > 6 \times I_n$		$\pm 15\% I \leq 6 \times I_n$ $\pm 20\% I > 6 \times I_n$		
S2	50TD	Time-delayed overcurrent protection	$I5 = 0.6 \dots 10 \times I_n$	$0.1 \times I_n$	$t5 = 0.05 \dots 0.8 \text{ s}$	0.01s
		Start up	Activation: $0.6 \dots 10 \times I_n$	$0.1 \times I_n$	Range: $0.1 \dots 30 \text{ s}$	0.01s
		Tolerance	$\pm 7\% I \leq 6 \times I_n$ $\pm 10\% I > 6 \times I_n$		The better of the two data: $\pm 10\%$ or $\pm 40 \text{ ms}$	
S(V)	51V	Voltage controlled overcurrent protection	$I20 = 0.6 \dots 10 \times I_n$	$0.1 \times I_n$	$t20 = 0.05 \dots 30 \text{ s}$	0.01s
		Step mode (controlled mode)	$UI = 0.2 \dots 1 \times U_n$	$0.01 \times U_n$		
			$Ks = 0.1 \dots 1$	0.01		
		Linear mode (restrained mode)	$UI = 0.2 \dots 1 \times U_n$	$0.01 \times U_n$		
			$Uh = 0.2 \dots 1 \times U_n$	$0.01 \times U_n$		
		Tolerance	$Ks = 0.1 \dots 1$	0.01		The better of the two data: $\pm 10\%$ or $\pm 40 \text{ ms}$
S2(V)	51V	Voltage controlled overcurrent protection	$I21 = 0.6 \dots 10 \times I_n$	$0.1 \times I_n$	$t21 = 0.05 \dots 30 \text{ s}$	0.01s
		Step mode (controlled mode)	$UI2 = 0.2 \dots 1 \times U_n$	$0.01 \times U_n$		
			$Ks2 = 0.1 \dots 1$	0.01		
		Linear mode (restrained mode)	$UI2 = 0.2 \dots 1 \times U_n$	$0.01 \times U_n$		
			$Uh2 = 0.2 \dots 1 \times U_n$	$0.01 \times U_n$		
		Tolerance	$Ks2 = 0.1 \dots 1$	0.01		The better of the two data: $\pm 10\%$ or $\pm 40 \text{ ms}$
I	50	Instantaneous overcurrent protection	$I3 = 1.5 \dots 15 \times I_n$	$0.1 \times I_n$	Instantaneous	-
		Start up	Activation: $1.5 \dots 15 \times I_n$	$0.1 \times I_n$	Range: $0.1 \dots 30 \text{ s}$	0.01s
		Tolerance	$\pm 10\%$		$\leq 30 \text{ ms}$	
MCR		Closing on short-circuit protection	$I3 = 1.5 \dots 15 \times I_n$	$0.1 \times I_n$	Instantaneous Activation range: $40 \dots 500 \text{ ms}$	0.01s
		Tolerance	$\pm 10\%$		$\leq 30 \text{ ms}$	



Excludibility	Excludibility trip	Pre-alarm	Trip curve	Ekip Touch	Ekip Hi-Touch	Ekip G Touch	Ekip G Hi-Touch
yes, with rating plug L=off	no	50...90% I1	$t = k / I^2$	●	●	●	●
yes				●	●	●	●
yes, with rating plug L=off	no	50...90% I1	$t = \frac{k t I}{\left(\frac{I}{I_1}\right)^\alpha - 1}$	●	●	●	●
yes	yes	no	$t = k$	●	●	●	●
yes				●	●	●	●
yes				●	●	●	●
yes	yes	no	$t = k / I^2$	●	●	●	●
yes				●	●	●	●
yes	yes	no	$t = k$		●		●
yes					●		●
yes	yes	no	$t = k$			●	●
yes						●	●
yes	yes	no	$t = k$				●
yes							●
yes							●
yes	no	no	$t = k$	●	●	●	●
yes				●	●	●	●
yes	no	no	$t = k$	●	●	●	●

Table continued on next page

Technical characteristics for protection trip units

Protection functions

3

ABB Code	ANSI Code	Function	Threshold	Threshold step	Tripping time	Time Step
G	50N/50N TD 68	Earth fault protection	$I4^{(1)} = I_{nst}, 0.1 \dots 1 \times I_n$	$0.001 \times I_n$	with $I > I_4, t_4 = 0.1 \dots 1s$	0.05s
		Zone selectivity			$t_{4sel} = 0.04 \dots 0.2s$	0.01s
		Start up Tolerance	Activation: $0.2 \dots 10 \times I_n$ $\pm 7\%$	$0.2 \times I_n$	range: $0.1 \dots 30s$ The better of the two data: $\pm 10\%$ or $\pm 40ms$	0.01s
	51N	Earth fault protection	$I4^{(1)} = 0.1 \dots 1 \times I_n$	$0.01 \times I_n$	with $I = 4 I_n, t_4 = 0.1 \dots 1s$	0.05s
		Tolerance	$\pm 7\%$		$\pm 15\%$	
	Gext	50G TD	Earth fault protection	$I4^{(1)} = 0.1 \dots 1 \times I_n$ Toroid	$0.001 \times I_n$ Toroid	$t_4 = 0.1 \dots 1s$
Start up			Activation: $0.1 \dots 1 \times I_n$	$0.02 \times I_n$	range: $0.1 \dots 30s$	0.01s
Tolerance			$\pm 7\%$		The better of the two data: $\pm 10\%$ or $\pm 40ms$	
51G		Earth fault protection	$I4^{(1)} = 0.1 \dots 1 \times I_n$	$0.001 \times I_n$	with $I = 4 I_n, t_4 = 0.1 \dots 1s$	0.01s
		Tolerance	$\pm 7\%$		$\pm 15\%$	
D	67	Directional overcurrent protection	$I7 = 0.6 \dots 10 \times I_n$	$0.1 \times I_n$	$t7 = 0.2 \dots 0.8s$	0.01s
	68	Zone selectivity			$t7sel = 0.13 \dots 0.5s$	0.01s
		Start up Tolerance	Activation: $0.6 \dots 10 \times I_n$ $\pm 7\% I7 \leq 6 \times I_n$ $\pm 10\% I7 > 6 \times I_n$	$0.1 \times I_n$	range: $0.1 \dots 0.8s$ The better of the two data: $\pm 10\%$ or $\pm 40ms$	0.01s
IU	46	Current unbalance protection	$I6 = 2 \dots 90\% I_n$ unbalance	$1\% I_n$	$t6 = 0.5 \dots 60s$	0.5s
		Tolerance	$\pm 10\%$		The better of the two data: $\pm 10\%$ or $\pm 40ms$	
Rc	64 50N TD 87N	Residual current protection Differential ground fault protection	$I\Delta n = 3 - 5 - 7 - 10 - 20 - 30A$		$t\Delta n = 0.06 - 0.1 - 0.2 - 0.3 - 0.4 - 0.5 - 0.8s$	
		Tolerance	$-20\% \div 0\%$		0.06s	
UV	27	Undervoltage Protection	$U8 = 0.5 \dots 0.98 \times U_n$	$0.001 \times U_n$	$t8 = 0.05 \dots 120s$	0.05s
		Tolerance	$\pm 5\%$		The better of the two data: $\pm 10\%$ or $\pm 40ms$	
UV2	27	Undervoltage Protection	$U15 = 0.5 \dots 0.98 \times U_n$	$0.001 \times U_n$	$t15 = 0.05 \dots 120s$	0.05s
		Tolerance	$\pm 5\%$		The better of the two data: $\pm 10\%$ or $\pm 40ms$	
OV	59	Overvoltage protection	$U9 = 1.02 \dots 1.5 \times U_n$	$0.001 \times U_n$	$t9 = 0.05 \dots 120s$	0.05s
		Tolerance	$\pm 5\%$		The better of the two data: $\pm 10\%$ or $\pm 40ms$	
OV2	59	Overvoltage protection	$U16 = 1.02 \dots 1.5 \times U_n$	$0.001 \times U_n$	$t16 = 0.05 \dots 120s$	0.05s
		Tolerance	$\pm 5\%$		The better of the two data: $\pm 10\%$ or $\pm 40ms$	
RV	59N	Residual overvoltage protection	$U22 = 0.1 \dots 0.5 \times U_n$	$0.001 \times U_n$	$t22 = 0.5 \dots 120s$	0.05s
		Tolerance	$\pm 5\%$		The better of the two data: $\pm 10\%$ or $\pm 40ms$	
VU	47	Voltage unbalance protection	$U14 = 2 \dots 90\% U_n$ unbalance	$1\% U_n$	$t14 = 0.5 \dots 60s$	0.5s
		Tolerance	$\pm 10\%$		The better of the two data: $\pm 10\%$ or $\pm 40ms$	
UF	81L	Underfrequency protection	$f12 = 0.9 \dots 0.99 \times f_n$	$0.01 \times f_n$	$t12 = 0.2 \dots 120s$	0.1s
		Tolerance	$\pm 5\%$		The better of the two data: $\pm 10\%$ or $\pm 40ms$, min = 30ms	
UF2	81L	Underfrequency protection	$f17 = 0.9 \dots 0.99 \times f_n$	$0.01 \times f_n$	$t17 = 0.2 \dots 120s$	0.1s
		Tolerance	$\pm 5\%$		The better of the two data: $\pm 10\%$ or $\pm 40ms$, min = 30ms	
OF	81H	Overfrequency protection	$f13 = 1.01 \dots 1.1 \times f_n$	$0.01 \times f_n$	$t18 = 0.2 \dots 120s$	0.1s
		Tolerance	$\pm 5\%$		The better of the two data: $\pm 10\%$ or $\pm 40ms$	



Excludibility	Excludibility trip	Pre-alarm	Trip curve	Ekip Touch	Ekip Hi-Touch	Ekip G Touch	Ekip G Hi-Touch
yes	yes	90% I4	t = k	●	●	●	●
yes				●	●	●	●
yes				●	●	●	●
yes	yes	90% I4	t = k / I ²	●	●	●	●
yes	yes	90% I4	t = k	●	●	●	●
yes				●	●	●	●
yes	yes	90% I4	t = k / I ²	●	●	●	●
yes	yes	no	t = k		●		●
yes					●		●
yes					●		●
yes	yes	no	t = k	●	●	●	●
Attivabile with rating plug Rc	no	no	t = k	●	●	●	●
yes	yes	no	t = k	○	●	●	●
yes	yes	no	t = k		●		●
yes	yes	no	t = k	○	●	●	●
yes	yes	no	t = k		●		●
yes	yes	no	t = k			●	●
yes	yes	no	t = k	○	●	●	●
yes	yes	no	t = k	○	●	●	●
yes	yes	no	t = k		●		●
yes	yes	no	t = k	○	●	●	●

Table continued on next page

Technical characteristics for protection trip units

Protection functions

3

ABB Code	ANSI Code	Function	Threshold	Threshold step	Tripping time	Time Step
OF2	81H	Overfrequency protection	$f18 = 1.01 \dots 1.1 \times f_n$	$0.01 \times f_n$	$t18 = 0.2 \dots 120s$	0.1s
		Tolerance	$\pm 5\%$		The better of the two data: $\pm 10\%$ or ± 40 ms	
ROCOF	81R	Rate of change of frequency protection	$f28 = 0.4 \dots 10$ Hz/s	0.2 Hz/s	with $f > f28$ $t28 = 0.5 \dots 10s$	0.1s
		Tolerance	$\pm 10\%$		The better of the two data: $\pm 20\%$ or ± 200 ms	
RP	32R	Reverse active power protection	$P11 = -1 \dots -0.05 S_n$	$0.001 S_n$	$t11 = 0.5 \dots 100s$	0.1s
		Tolerance	$\pm 10\%$		The better of the two data: $\pm 10\%$ or ± 40 ms	
RQ	40/32R	Loss of field or reverse reactive power protection	$Q24 = -1 \dots -0.1 S_n$	$0.001 S_n$	$t24 = 0.5 \dots 100s$	0.1s
			$Kq = -2 \dots 2$	0.01		
		Loss of field or reverse reactive power protection	$Q25 = -1 \dots -0.1 S_n$	$0.001 S_n$	$t24 = 0.5 \dots 100s$	0.1s
			$Kq2 = -2 \dots 2$	0.01		
	Tolerance	$\pm 10\%$		The better of the two data: $\pm 10\%$ or ± 40 ms		
OP	320F	Active overpower protection	$P26 = 0.4 \dots 2 S_n$	$0.001 S_n$	$t26 = 0.5 \dots 100s$	0.5s
		Tolerance	$\pm 10\%$		The better of the two data: $\pm 10\%$ or ± 40 ms	
OQ	320F	Reactive overpower protection	$Q27 = 0.4 \dots 2 S_n$	$0.001 S_n$	$t27 = 0.5 \dots 100s$	0.5s
		Tolerance	$\pm 10\%$		The better of the two data: $\pm 10\%$ or ± 40 ms	
UP	32LF	Active underpower protection	$P23 = 0.1 \dots 1 \times S_n$	$0.001 \times S_n$	$t23 = 0.5 \dots 100s$	0.5s
		Temporary deactivation			range from closing: 0.1...30s o with digital input	
		Tolerance	$\pm 10\%$		The better of the two data: $\pm 10\%$ or ± 40 ms	
Synchrocheck SC	25	Synchrocheck (Live busbars)	$U_{live} = 0.5 \dots 1.1 U_n$ $\Delta U = 0.02 \dots 0.12 U_n$ $\Delta f = 0.1 \dots 1$ Hz $\Delta \Phi = 5 \dots 50^\circ$ elt	$0.001 U_n$ $0.001 U_n$ 0.1 Hz 5° elt	$t_{ref} = 0.1 \dots 30s$ Time settings stability voltage time for live state = 0.1...30s Minimum matching Time= 0.1...3s	0.1s
		Tolerance	$\pm 10\%$			
		Synchrocheck (Live, Dead busbars)	$U_{live} = 0.5 \dots 1.1 U_n$ $U_{dead} = 0.02 \dots 0.2 U_n$	0.01 U_n 0.01 U_n	$t_{ref} = 0.1 \dots 30s$	
	Tolerance	$\pm 10\%$				
	47	Cyclical direction of the phases	1-2-3 or 3-2-1			
	78	3phase Power factor	$PF3 = 0.2 \dots 0.95$	0.01		
Current threshold		$LC1 = 50\% \dots 100\% I1$ $LC2 = 50\% \dots 100\% I1$ $I_w = 0.3 \dots 10 I_n$	1% 1% $0.01 \times I_n$			
Tolerance		$\pm 10\%$				

1) G protection below 100A or $0.2 \times I_n$ available with auxiliary supply.
The tollerances above apply to trip units already powered by the main circuit with current flowing in at least two-phases or an auxiliary power supply.
In all other cases the following tollerance values apply:

ABB Code	Trip threshold	Trip time
L	Trip between 1.05 and $1.2 \times I1$	$\pm 20\%$
S	$\pm 10\%$	$\pm 20\%$
I	$\pm 15\%$	$\leq 60ms$
G	$\pm 15\%$	$\pm 20\%$
Other protection	$\pm 15\%$	$\pm 20\%$



Excludibility	Excludibility trip	Pre-alarm	Trip curve	Ekip Touch	Ekip Hi-Touch	Ekip G Touch	Ekip G Hi-Touch
yes	yes	no	t = k		●		●
yes	yes	no	t = k				●
yes	yes	no	t = k	○	●	●	●
yes	yes	no	t = k			●	●
yes	yes	no	t = k				●
yes	yes	no	t = k			●	●
yes	yes	no	t = k			●	●
yes	yes	no	t = k			●	●
yes	yes	no	t = k			●	●
yes	only signalling	no	-	○ ○○	○○	○○	○○
yes	only signalling	no	-				
yes	only signalling	no	-	○	●	●	●
yes	only signalling	no	-	○	●	●	●
yes	only signalling	no	-	●	●	●	●

Key:
 - not available
 ● available
 ○ available with Ekip Measuring and Ekip Measuring Pro
 ○○ available with Ekip Synchrocheck

Technical characteristics for protection trip units

Measurement functions

3

Instantaneous measurements		Displayed with Ekip Multimeter	Parameters
Currents (RMS)	[A]	•	L1, L2, L3, Ne
Earth fault current (RMS)	[A]	•	Ig
Record of values: of the parameter for each interval with time-stamping			Parameters
Current: minimum and maximum	[A]	•	I Min, I Max
Information on trip and opening data: after a fault with or without auxiliary supply			Parameters
Type of protection tripped		•	eg. L, S, I, G
Fault values per phase	[A]	•	eg. I1, I2, I3, neutral for S protection
Time-stamping		•	Date, time and progressive number
Maintenance indicators			Parameters
Information on last 30 trips		•	Type of protection, fault values and time-stamping
Information on last 200 events		•	Type of event, time-stamping
Number of mechanical operations ⁽¹⁾	[no]	•	Can be associated to alarm
Total number of trips	[no]	•	
Total operating time	[h]	•	
Wear of contacts	[%]	•	Prealarm >80%, Alarm = 100%
Date of maintenance operations performed		•	Last
Indication of maintenance operation needed		•	
Circuit-breaker I.D.		•	Type of circuit-breaker, assigned device name, serial number
Self-diagnosis			Parameters
Check of continuity of internal connections		•	Alarm due to disconnection: rating plug, sensors, trip coil
Failure of circuit-breaker to open (ANSI 50BF)		•	Alarm following non-tripping of protection functions
Temperature (T)		•	Pre-alarm and alarm for abnormal temperature

⁽¹⁾ with auxiliary supply present



Precision	Standard di riferimento	Ekip Dip
1%	Class 1 IEC 61557-12	●
2%		●
Window	Intervals	
Fixed, synchronizable by remote	Duration: 5...120min Number of intervals: 24	●
		●
		●
		●
		●
		●
		●
		●
		●
		●
		●
		●
		●
Note: Opening of circuit-breaker can be set in the event of alarm		●
		●
		●

Technical characteristics for protection trip units

Measurement functions

3

Instantaneous measurements		Parameters
Currents (RMS)	[A]	L1, L2, L3, Ne
Earth fault current (RMS)	[A]	Ig
Phase-phase voltage (RMS)	[V]	U12, U23, U31
Phase-neutral voltage (RMS)	[V]	U1, U2, U3
Phase sequence		
Frequency	[Hz]	f
Active power	[kW]	P1, P2, P3, Ptot
Reactive power	[kVAR]	Q1, Q2, Q3, Qtot
Apparent power	[kVA]	S1, S2, S3, Stot
Power factor		PF1, PF2, PF3, PF total
Peak factor		total
Counters recorded from installation or from the last reset		Parameters
Active energy	[kWh]	Ep total, Ep positive, Ep negative
Reactive energy	[kVARh]	Eq total, Eq positive, Eq negative
Apparent energy	[KVAh]	Es total
Network Analyzer		Parameters
Hourly average voltage value	[V] [no]	- Umin= 0.75...0.95 x Un - Umax= 1.05...1.25 x Un - Events counter (nr. of events day by day in the last year plus the total events in the breaker's lifetime)
Short voltage interruptions	[no]	- Umin= 0.75...0.95 x Un - Events counter (nr. of events day by day in the last year plus the total events in the breaker's lifetime)
Short voltage spikes	[no]	- Umax= 1.05...1.25 x Un - Events counter (nr. of events day by day in the last year plus the total events in the breaker's lifetime)
Slow voltage sags and swells	[no]	- Umin1= 0.75...0.95 x Un - Umin2= 0.75...0.95 x Un - Umin3= 0.75...0.95 x Un - Umax1= 1.05...1.25 x Un - Umax2= 1.05...1.25 x Un - Events counter (nr. of events day by day in the last year plus the total events in the breaker's lifetime)
Voltage unbalance	[V] [no]	- U neg. seq.= 0.02...0.10 x Un - Events counter (nr. of events day by day in the last year plus the total events in the breaker's lifetime)
Harmonic analysis		Current and Voltage - up to 50° - Alarm THD: 5...20% - Single harmonic alarm: 3...10% plus a count of minutes the harmonic has been exceeded



	Ekip Touch	Ekip Hi-Touch	Ekip G Touch	Ekip G Hi-Touch
Precision				
1%	●	●	●	●
2%	●	●	●	●
0.5%	○	●	●	●
0.5%	○	●	●	●
	○	●	●	●
0.2%	○	●	●	●
2%	○	●	●	●
2%	○	●	●	●
2%	○	●	●	●
2%	○	●	●	●
2%	○	●	●	●
Precision				
2%				
2%				
2%				
Intervals				
t = 5...120min	-	●	-	●
t <40ms	-	●	-	●
t <40ms	-	●	-	●
t = 0.02s...60s	-	●	-	●
t = 5...120min	-	●	-	●
	-	●	-	●

Technical characteristics for protection trip units

Measurement functions

3

Record of values: of the parameter for each interval with time-stamping		Parameters
Current: minimum and maximum	[A]	I Min, I Max
Phase-phase voltage: minimum and maximum	[V]	U Min, U max
Active power: average and maximum	[kW]	P Mean, P Max
Reactive power: average and maximum	[kVAR]	Q Mean, Q Max
Apparent power: average and maximum	[KVA]	S Mean, S Max
Data logger: record of high sampling rate parameters		Parameters
Currents	[A]	L1, L2, L3, Ne, Ig
Voltages	[V]	U12, U23, U31
Sampling rate	[Hz]	1200-9600
Maximum recording duration	[s]	18
Recording stop delay	[s]	0-10s
Number of registers	[no]	2 independent
Information on trip and opening data: after a fault without auxiliary supply		Parameters
Type of protection tripped		eg. L, S, I, G, UV, OV
Fault values per phase	[A/V/Hz w/VAR]	eg. I1, I2, I3, neutral for S protection V12, V23, V32 for UV protection
Time-stamping		Date, time and progressive number
Maintenance indicators		Parameters
Information on last 30 trips		Type of protection, fault values and time-stamping
Information on last 200 events		Type of event, time-stamping
Number of mechanical operations ⁽¹⁾	[no]	Can be associated to alarm
Total number of trips	[no]	
Total operating time	[h]	
Wear of contacts	[%]	Prealarm >80% Alarm = 100%
Date of maintenance operations performed		Last
Indication of maintenance operation needed		
Circuit-breaker I.D.		Type of circuit-breaker, assigned device name, serial number
Self-diagnosis		Parameters
Check of continuity of internal connections		Alarm due to disconnection: rating plug, sensors, trip coil
Failure of circuit-breaker to open (ANSI 50BF)		Alarm following non-tripping of protection functions
Temperature (OT)		Prealarm and alarm for abnormal temperature

(1) with auxiliary supply present

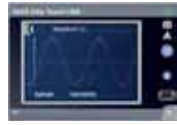

Window	Intervals	Ekip Touch	Ekip Hi-Touch	Ekip G Touch	Ekip G Hi-Touch		
Fixed synchronizable by remote	Duration: 5...120min Number of intervals: 24	●	●	●	●		
		●	●	●	●		
		○	●	●	●		
		○	●	●	●		
		○	●	●	●		
		●	●	●	●		
		○	●	●	●		
		●	●	●	●		
		●	●	●	●		
		●	●	●	●		
		●	●	●	●		
		●	●	●	●		
		●	●	●	●		
		●	●	●	●		
		●	●	●	●		
		●	●	●	●		
		●	●	●	●		
		●	●	●	●		
		●	●	●	●		
		●	●	●	●		
		Note: Opening of circuit-breaker can be set in the event of alarm		●	●	●	●
				●	●	●	●
				●	●	●	●

Key:
- not available
● available
○ available with Ekip Measuring Pro

Communication devices and systems

Introduction 4/2

Supervision and control

Supervision of the switchgear compartment	4/4
Switchgear supervision	4/6
Supervision of the electrical installation	4/8

Software

Ekip Connect	4/10
Ekip View	4/12
Ekip T&P Interface	4/14

Communication devices and systems





Introduction

SACE Emax 2 circuit-breakers provide a complete and flexible offering that can be adapted to the actual level of supervision and control required.

The rapid spread of systems for the supervision and control of low voltage electrical distribution plants is determined by the growing need to:







- optimize energy efficiency by analyzing energy consumption;
- ensure service continuity, minimizing the time needed to identify and rectify faults;
- guarantee efficient planning of maintenance activities.

4

Typical sector	Industrial	Hospital	OEMs	Naval
				
Level of supervision and control in low voltage systems	Switchgear compartment			
Solution with SACE Emax 2	<ul style="list-style-type: none"> - Ekip Touch trip units with high resolution display 	<ul style="list-style-type: none"> - Ekip trip units - Ekip Multimeter display on the front of switchgear 		
Benefit of the ABB solution	<ul style="list-style-type: none"> - simple and intuitive use - does not require an auxiliary power supply for safety 	<ul style="list-style-type: none"> - reduced dimensions - flexible installation - simultaneous reading of various electrical values 		

According to their complexity, the supervision of low voltage systems may involve different levels:

- **switchgear compartment:** for control of the main electrical values of the circuit-breaker. It provides a general but precise indication of the level of absorption of the system (main circuit-breaker) and the individual utilities (outgoing feeder circuit-breakers).
- **electrical switchgear:** to display the data of all circuit-breakers installed in the switchgear from a single point: in local mode via the operator panel on the front of the switchgear, or remotely via an Internet connection.
- **electrical system:** to manage complex systems in which devices must be integrated with automated industrial processes or in intelligent electrical networks, better known as smart grids.

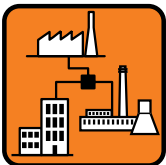
Industries of medium dimensions	Shopping centres	Office buildings	Oil & gas	Automated industrial processes	Data centers	Smart grids
						
Electrical switchgear				Electrical installation		
<ul style="list-style-type: none"> - Ekip trip units - Ekip Link module - Ekip Control Panel operator panel colour touch screen - Standardized EtherNet components 				<ul style="list-style-type: none"> - Ekip Touch trip units - Ekip Com communication modules - Ekip View supervision software 		
<ul style="list-style-type: none"> - centralized control from the front of switchgear - access to the installation via the web - rapid installation - ease of use - system ready to use 				<ul style="list-style-type: none"> - wide range of protocols supported - installation times reduced to a minimum - redundancy of communication - ready to smart grid circuit-breakers - complete network supervision 		

Communication devices and systems

Supervision of the switchgear compartment

The SACE Emax 2 circuit-breakers equipped with Ekip electronic trip units enable electrical measurements and diagnostic data to be displayed on the front of the switchgear.

Solution with Ekip Touch trip units

The Ekip Touch electronic trip units are the ideal solution for supervision and control of the compartments in switchgear. In particular:

4

- their use is simple and intuitive thanks to a large, high resolution, colour touch screen;
- they do not require an auxiliary power supply for safety; the Ekip Touch trip units are directly supplied by the current sensors integrated in the circuit-breaker, thereby avoiding the use of external power supplies.

Ekip Touch



Ekip Multimeter

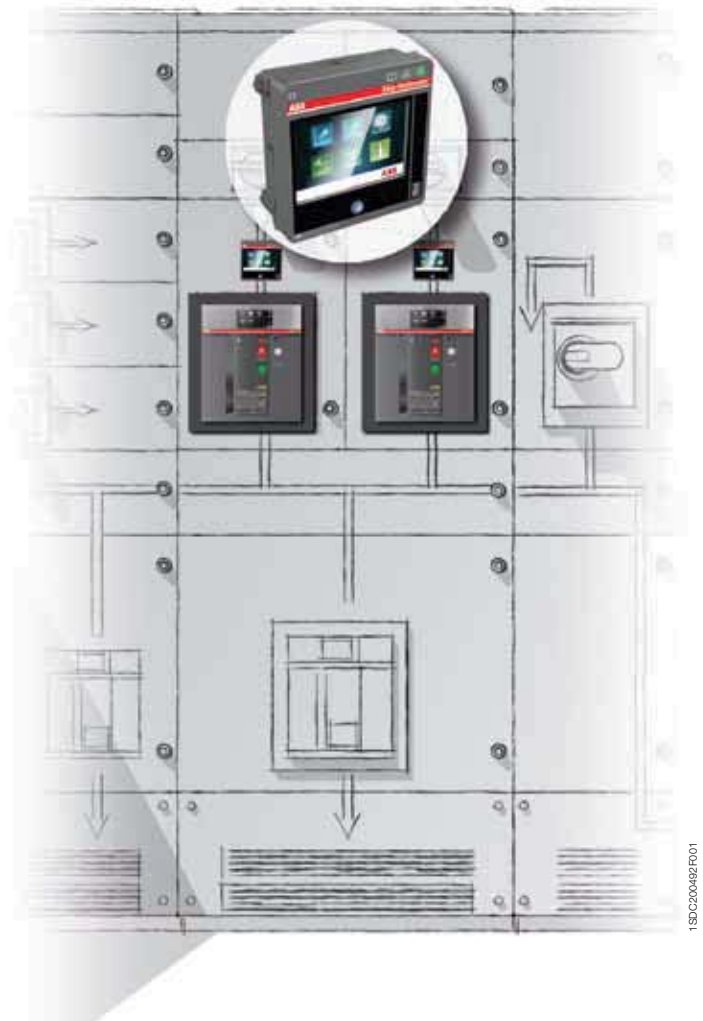

For the list of information available for each trip unit, consult chapter 3.

Solution with Ekip Multimeter Display on the front of the switchgear

The Ekip Multimeter is a display unit to be installed on the front of the switchgear for SACE Emax 2 air circuit-breakers equipped with Ekip electronic trip units.

This device remotely displays the information about the system that is available in the trip unit to which it is connected. The main characteristics of the Ekip Multimeter unit are:

- **Graphical and functional uniformity with the Ekip Touch trip units;** Ekip Multimeter uses the same display as the trip unit to which it is connected, ensuring perfect continuity between the graphic display and the menu items.
- **Reduced dimensions;** the Ekip Multimeter guarantees the precision of the trip unit to which it is connected and performs the function of a measuring instrument without requiring the installation of external current and voltage transformers.
- **Flexible installation;** the Ekip Multimeter can be installed up to distance from the trip unit, enabling access to information from the most convenient point.
- **Simultaneous reading of the various electrical values;** the advanced connection system used allows several Ekip Multimeter devices to be connected to the same protection trip unit.

Furthermore, if connected to trip units equipped with display, the Ekip Multimeter enables adjustment of the parameters and protection thresholds.

Electronic trip unit	Supervision of switchgear compartment			
	Ekip Dip	Ekip Touch	Ekip Touch + Ekip measuring module Ekip G Touch	Ekip Hi Touch Ekip Hi-G Touch
Solution	Ekip trip units + Ekip Multimeter			
Type of trip units connectable to Ekip Multimeter	Ekip trip units			
Number of trip units connectable to Ekip Multimeter	1			
Measurement functions				
Currents	•	•	•	•
Voltages	-	-	•	•
Powers	-	-	•	•
Energies	-	-	•	•
Harmonics	-	-	-	•
Network analyzer	-	-	-	•
Adjustment functions				
Setting of thresholds	-	•	•	•
Setting of thresholds second set	-	-	-	•
Resetting of alarms	•	•	•	•
Diagnostics				
Protection function alarms	•	•	•	•
Device alarms	•	•	•	•
Protection unit tripping details	•	•	•	•
Events log	•	•	•	•
Protection unit tripping log	•	•	•	•
Maintenance				
Number of operations	•	•	•	•
Number of trips	•	•	•	•
Wear of contacts	•	•	•	•
Other data				
Status of circuit-breaker	•	•	•	•
Circuit-breaker position ¹⁾	•	•	•	•
Local/remote mode	•	•	•	•

1) Circuit-breakers equipped with auxiliary contacts to indicate position

Communication devices and systems

Switchgear supervision

Ekip Link is a flexible and efficient solution for controlling and supervising low voltage electrical switchgear; it is a system that enables SACE Emax 2 circuit-breakers to be connected to the Ekip Control Panel operator panel by means of Ekip Link interface modules.

Ekip Link system

The main characteristics of the Ekip Link System are:

- **centralized control**; from the Ekip Control Panel operator panel, all the main values of the installation (electrical measurements, system diagnostics, trends...) monitored and controlled.
- **adaptation to real requirements**; when the electrical values to be monitored are limited to currents only, the Ekip Dip trip unit can be connected to the Ekip Link without having to use circuit-breakers equipped with communication modules.
- **access via the Internet** to the installation by any Internet browser using the web server function performed by the Ekip Control Panel.
- **rapid installation**, through the use of standardized EtherNet components such as STP cables and RJ45 type connectors.
- **ease of use**; due to the Ekip Control Panel operator panel in front of the switchgear with colour touch screen, the system mimic panel can be displayed so that the entire installation can be controlled rapidly and intuitively.
- **ready to use**; Ekip Control Panel is supplied with pre-configured software that requires no programming. It is only necessary to start scanning the Ekip Link system from the operator panel and in a few seconds communication with the connected devices is active.

Ekip Link enables supervision of electrical switchgear on which up to 30 ABB SACE circuit-breakers have been installed. Tmax T and Tmax XT series circuit-breakers equipped with Modbus RTU communication can also be easily integrated into the Ekip Link system using the multi-serial port fitted on the Ekip Control Panel.

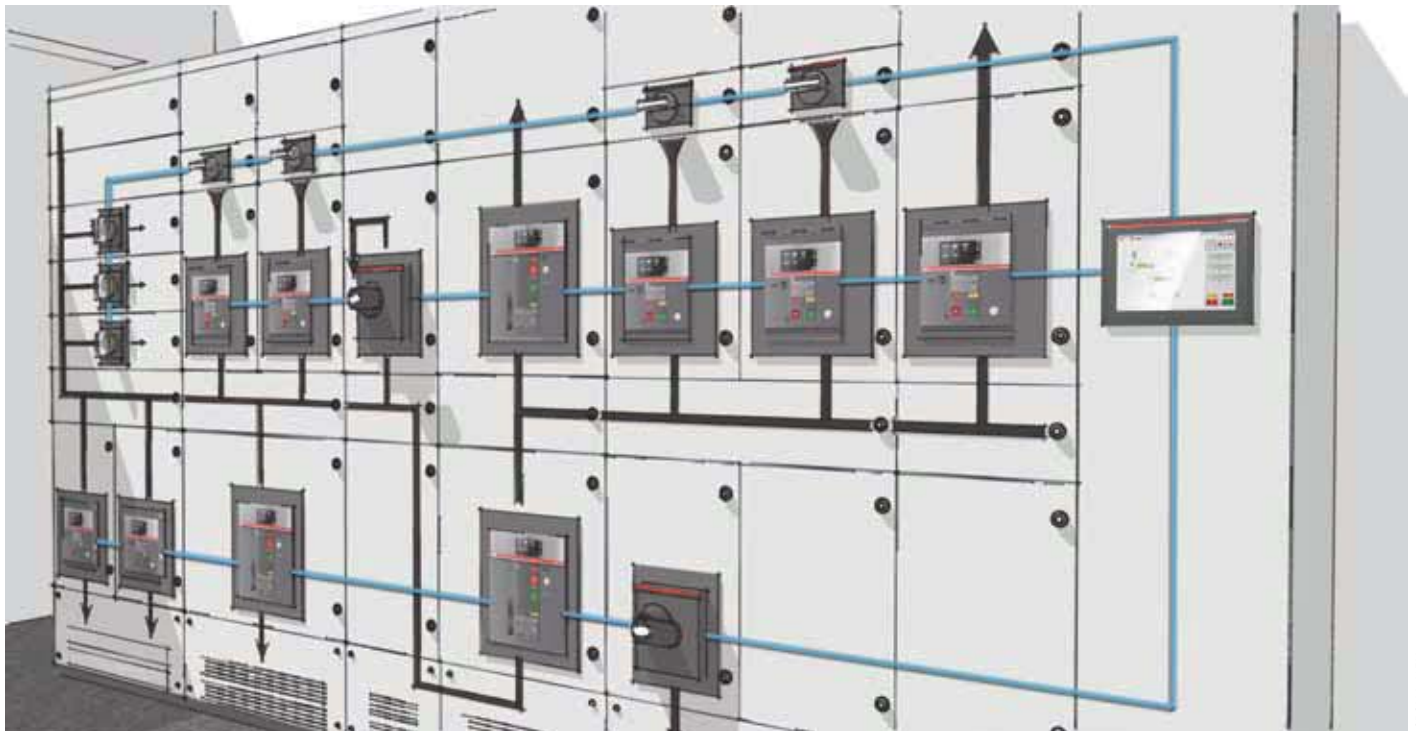

	Switchgear supervision			
Electronic trip unit	Ekip Dip	Ekip Touch	Ekip Touch + Ekip measuring module Ekip G Touch	Ekip Hi Touch Ekip Hi-G Touch
Solution	Ekip protection trip units equipped with Ekip link module + Ekip Control Panel operator panel + standard EtherNet components			
Type of trip units connectable	Ekip protection trip units			
Number of trip units connectable to the Ekip link system	up to 30 ¹⁾			
Data exchange rate of Ekip link system	100 Mbit/sec			
Supervision and control functions				
Opening and Closing of circuit-breakers ²⁾	•	•	•	•
Electrical value trends			I,V,P	I,V,P
Log of electrical value trends			I,V,P	I,V,P
Dynamic installation mimic panel	•	•	•	•
Automatic scanning of the Ekip link system	•	•	•	•
Centralized synchronizing of time	•	•	•	•
Web server function	• ³⁾	• ³⁾	• ³⁾	• ³⁾
Measurement functions				
Currents	•	•	•	•
Voltages	-	-	•	•
Powers	-	-	•	•
Energies	-	-	•	•
Harmonics	-	-	-	•
Network analyzer	-	-	-	•
Data logger	-	•	•	•
Adjustment functions				
Setting of thresholds	-	•	•	•
Resetting of alarms	•	•	•	•
Diagnostics				
Protection function alarms	•	•	•	•
Device alarms	•	•	•	•
Protection unit tripping details	•	•	•	•
Events log	•	•	•	•
Protection unit tripping log	•	•	•	•
Transmission of alarms via SMS	optional	optional	optional	optional
Transmission of alarms via e-mail	optional	optional	optional	optional
Maintenance				
Number of operations	•	•	•	•
Number of trips	•	•	•	•
Wear of contacts	•	•	•	•
Other data				
Status of circuit-breaker	•	•	•	•
Circuit-breaker position ⁴⁾	•	•	•	•
Local/remote mode	•	•	•	•

1) Ekip Control Panel is available in two versions that can manage a maximum of 10 or 30 circuit-breakers. The number of circuit-breakers may vary depending on their type. For details, ask ABB SACE

2) Circuit-breakers equipped with actuation module, electric accessories, opening and closing releases and spring charging motor

3) Two client web accesses included in the licence

4) Circuit-breakers equipped with auxiliary contacts to indicate position

Communication devices and systems

Supervision of the electrical installation

The integration of low voltage devices in communication networks is required in particular for: automated industrial processes, industrial and petrochemical sites, modern data centres and intelligent electricity networks, better known as smart grids.

Ekip Com Modules

Thanks to the wide range of communication protocols supported, SACE Emax 2 circuit-breakers equipped with Ekip Touch electronic trip units can be integrated into communication networks without the need for external interface devices.

4

The distinctive characteristics of the SACE Emax 2 circuit-breakers offering for industrial communication are:

- **Wide range of protocols supported;** the Ekip Com communication modules enable integration with the most common communication protocols based on RS485 serial lines and the most modern communication systems based on EtherNet infrastructures, which guarantee an exchange of data in the order of 100 Mbit/s.
- **Installation times reduced to a minimum** due to the plug & play technology of the communication modules, which are connected directly to the circuit-breaker terminal box without having to remove the electronic trip unit.
- **Repetition of communication for greater reliability of the system;** the circuit-breaker can be equipped with two communication modules at the same time, allowing the information on two buses to be exchanged simultaneously.
- **Ready to smart grid;** the Ekip Com 61850 module is the solution for integrating SACE Emax 2 circuit-breakers into the automated systems of electrical substations based on the IEC 61850 standard without the need for complex external devices.
- **Complete supervision** of Modbus RTU or Modbus TCP/IP networks via the software for PC Ekip View.

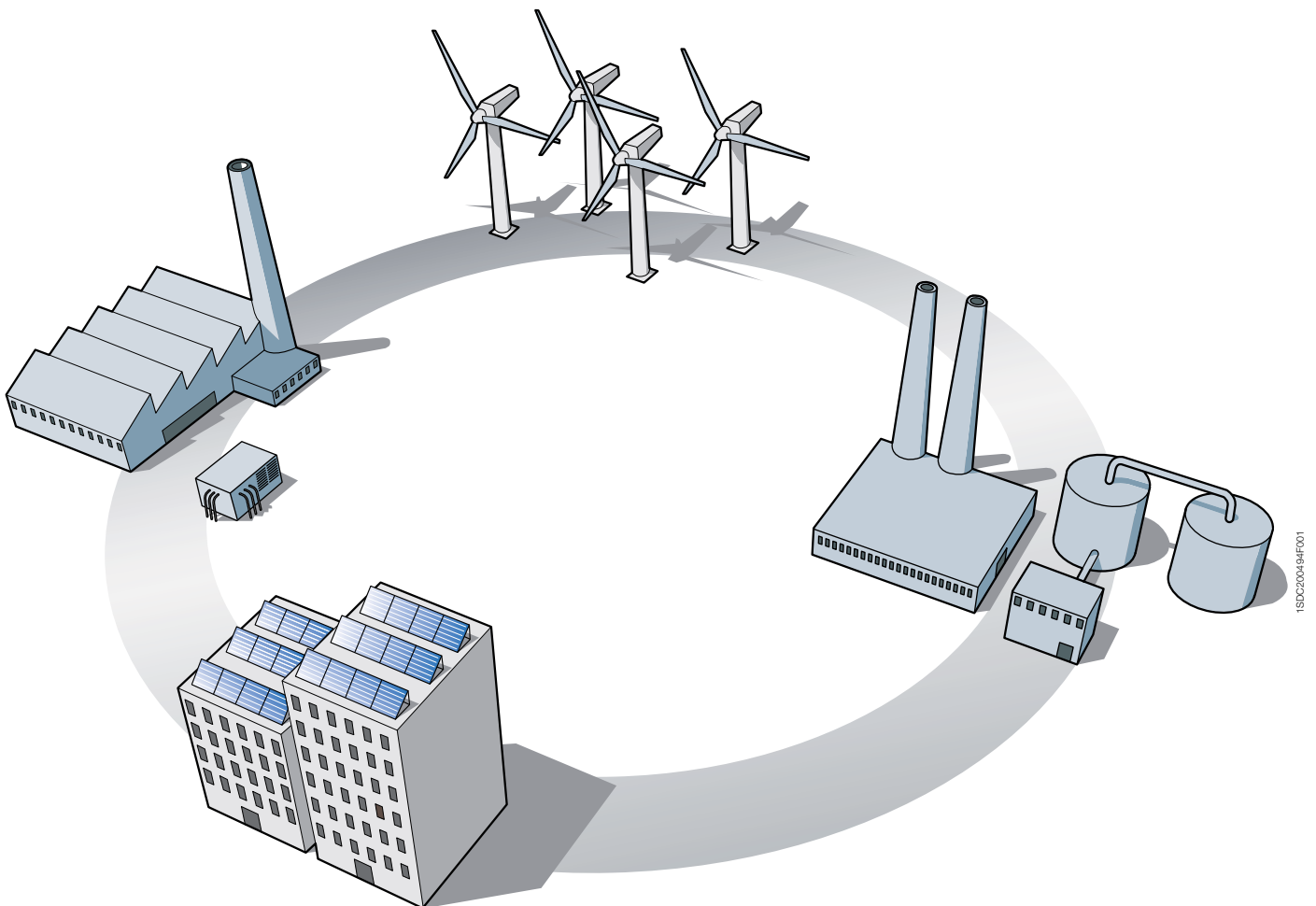

	Supervision of the electrical installation		
Electronic trip unit	Ekip Touch	Ekip Touch + Ekip measuring module Ekip G Touch	Ekip Hi Touch Ekip Hi-G Touch
Solution	Ekip Touch trip units + Ekip com modules		
Protocols supported:			
Modbus RTU	Ekip com Modbus		
Profibus-DP	Ekip com Profibus		
DeviceNet	Ekip com DeviceNet		
Modbus TCP/IP	Ekip com Modbus TCP		
Profinet	Ekip com Profinet		
EtherNet IP	Ekip com EtherNet		
IEC61850	Ekip com IEC61850		
Control functions			
Circuit-breakers opening and closing ¹⁾	•	•	•
Measurement functions			
Currents	•	•	•
Voltages	-	•	•
Powers	-	•	•
Energies	-	•	•
Harmonics	-	-	•
Network analyzer	-	-	•
Data logger	•	•	•
Adjustment functions			
Setting of thresholds	•	•	•
Resetting of alarms	•	•	•
Diagnostic			
Protection function alarms	•	•	•
Device alarms	•	•	•
Protection unit tripping details	•	•	•
Events log	•	•	•
Protection unit tripping log	•	•	•
Maintenance			
Number of operations	•	•	•
Number of trips	•	•	•
Wear of contacts	•	•	•
Other data			
Status of circuit-breaker	•	•	•
Circuit-breaker position ²⁾	•	•	•
Local/remote mode	•	•	•

1) Circuit-breakers equipped with Ekip Com Actuator module, electrical accessories, opening and closing releases and spring charging motor
2) Circuit-breakers equipped with auxiliary contacts to indicate position

Communication devices and systems

Supervision and control software

ABB SACE offers software applications that allow the potential of the Ekip electronic trip units to be utilized in the best possible way in terms of the management of power, acquisition and analysis of the electrical values, and testing of the protection, maintenance and diagnostic functions.

Overview of the software

An overview of the software available and their main characteristics are given below:

Software	Functions	Distinctive characteristics
Ekip Connect	<ul style="list-style-type: none"> - commissioning of circuit-breakers - analysis of faults - testing of communication bus 	<ul style="list-style-type: none"> - simple and intuitive use - integrated with DOC electrical design software - useable via EtherNet - automatic updating from Internet - off-line mode - multi-media (smart phone, tablet or PC)
Ekip View	<ul style="list-style-type: none"> - supervision and control of communication networks - analysis of electrical value trends - condition monitoring 	<ul style="list-style-type: none"> - engineering free - analysis of past trends - customizable reports - access via Internet to the installation - possibility of integrating third party devices
Ekip T&P interface	<ul style="list-style-type: none"> - testing of protection functions - ordinary maintenance of trip units 	<ul style="list-style-type: none"> - test signals can be pre-set or configured as desired - advanced graphical interface - generation of test reports

Ekip Connect

Ekip Connect enables data to be exchanged with one or more protection trip units, which:

- **Assists commissioning of the system;** all system parameters and the protection thresholds can be set rapidly in the Ekip trip units thanks to the easy and intuitive navigation pages of the software.
- **Permits rapid access to diagnostics;** it is possible to consult and download the records of events, alarms and the tripping of the trip units, thereby facilitating the identification and understanding of the anomalies.

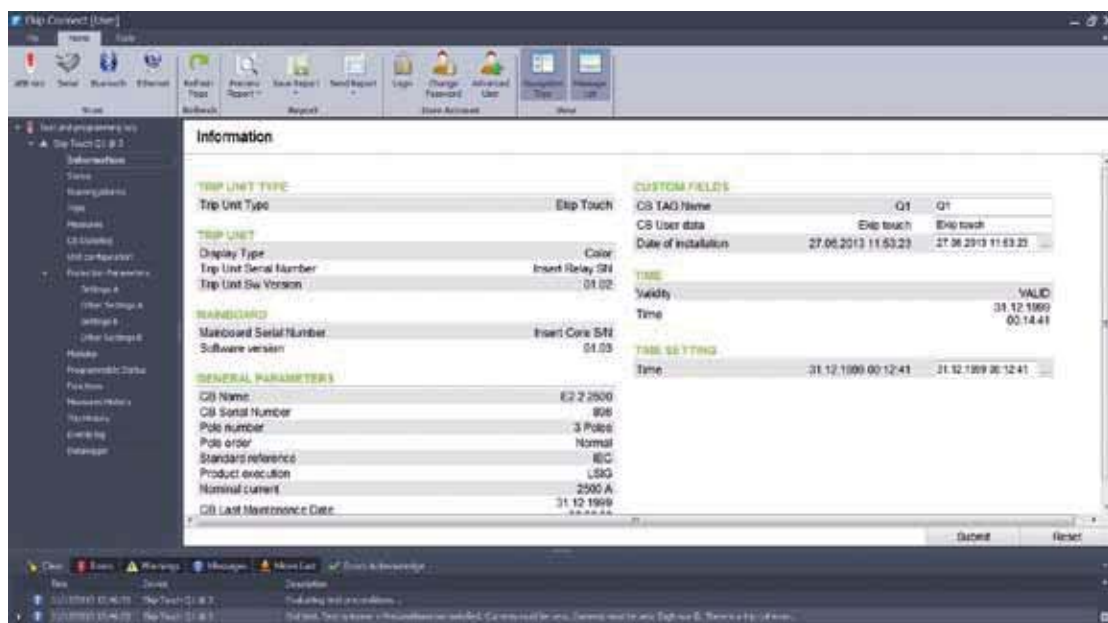

- **Enables testing of the communication network;** Ekip Connect performs an automatic scan of the Modbus RS-485 or Modbus TCP network and determines whether the circuit-breakers have been correctly connected and, when necessary, signals incorrect configurations of the communication parameters (addresses, baud rate, parity).

The distinctive characteristics of the software are:

- **Integration with DOC electrical design software;** the adjustments and settings calculated by the DOC software can be downloaded directly into the protection trip units, thereby reducing commissioning times and the potential for errors.
- **Ease of connection:** the Ekip trip units equipped with Modbus TCP Ekip com modules can be controlled directly by the EtherNet network.
- **Multi-media;** Ekip Connect is designed to operate on a PC or on the more modern tablet PCs and smart phones.
- **Automatic updating from the Internet site;** if connected to an Internet site, the software is able to constantly control the availability of any updates.

The software is available free of charge on the ABB website www.abb.com/lowvoltage.

Media	Ekip Connect Software				
	Personal PC			Smartphone/Tablet	iPhone/iPad
Operating system	Windows XP, Windows 7, Windows Vista			Android	iOS
Method of connection to the trip units	Communication network	Test connector	Wireless communication	Wireless communication	Wireless communication
SACE Emax 2 trip units	Ekip com Modbus RS485 or TCP	Ekip T&P	Ekip Bluetooth	Ekip Bluetooth	Ekip Bluetooth
SACE Tmax XT trip units	Ekip com	Ekip T&P	Ekip Bluetooth	-	-
SACE Emax, T7, X1, T8 trip units	PR120/D-M, PR330/D-M	Ekip T&P or BT030	BT030	-	-
SACE Tmax T trip units	PR222DS/PD, PR223DS; PR223/EF	Ekip T&P or BT030	BT030	-	-
Functions of reading and control					
Automatic network scan	•	-	-	-	-
Opening and closing of circuit-breakers ¹⁾	•	•	•	•	•
Setting of thresholds	•	•	•	•	•
Resetting of alarms	•	•	•	•	•
Reading of electrical measurements	•	•	•	•	•
Displaying of time-current curve	•	•	•	•	•
Reading of past records	•	•	•	•	•
DataLogger download	•	•	•	-	-
Other functions					
Generating of Reports	•	•	•	•	•
Automatic updating from Internet	•	•	•	•	•
Integration with DOC	•	•	•	•	•
Enabling of Ekip T&P Interface	•	•	•	•	•
Use via EtherNet	• ²⁾	-	-	-	-

1) Circuit-breakers equipped with auxiliary contacts to indicate position

2) only in the presence of Modbus TCP Ekip Com modules

Communication devices and systems

Supervision and control software

Ekip View

Ekip View is the software for supervising devices connected to a communication network that uses the Modbus RTU or Modbus TCP protocol.

It is the ideal tool for all applications that require:

- remote control of the system,
- monitoring of power consumption,
- fault detection of the system,
- allocation of energy consumption to the different processes and departments,
- preventative planning of maintenance.

4

The main characteristics of Ekip View are:

- **Engineering free** and ready to use **software** which guides the user in the recognition and configuration of the protection units without the need for any supervision system engineering activities.
- **Dynamic mimic panel;** after automatic scanning of the network, for each of the devices found, Ekip View proposes a dynamic symbol that summarizes the most important information (status, electrical measurements, alarms). The extensive library of electrical symbols enables the entire electrical system to be depicted in detail.
- **Analysis of trends;** the instantaneous and past trends of currents, powers and power factors are represented graphically and can be exported into Microsoft Excel for detailed analysis.
- **Reports;** advanced reports can be created regarding system and communication network diagnostics. Using the Alarm Dispatcher option, the user can receive the most important indications via SMS or e-mail.
- **Access via web** to the installation, thanks to the Web Server function of Ekip View.

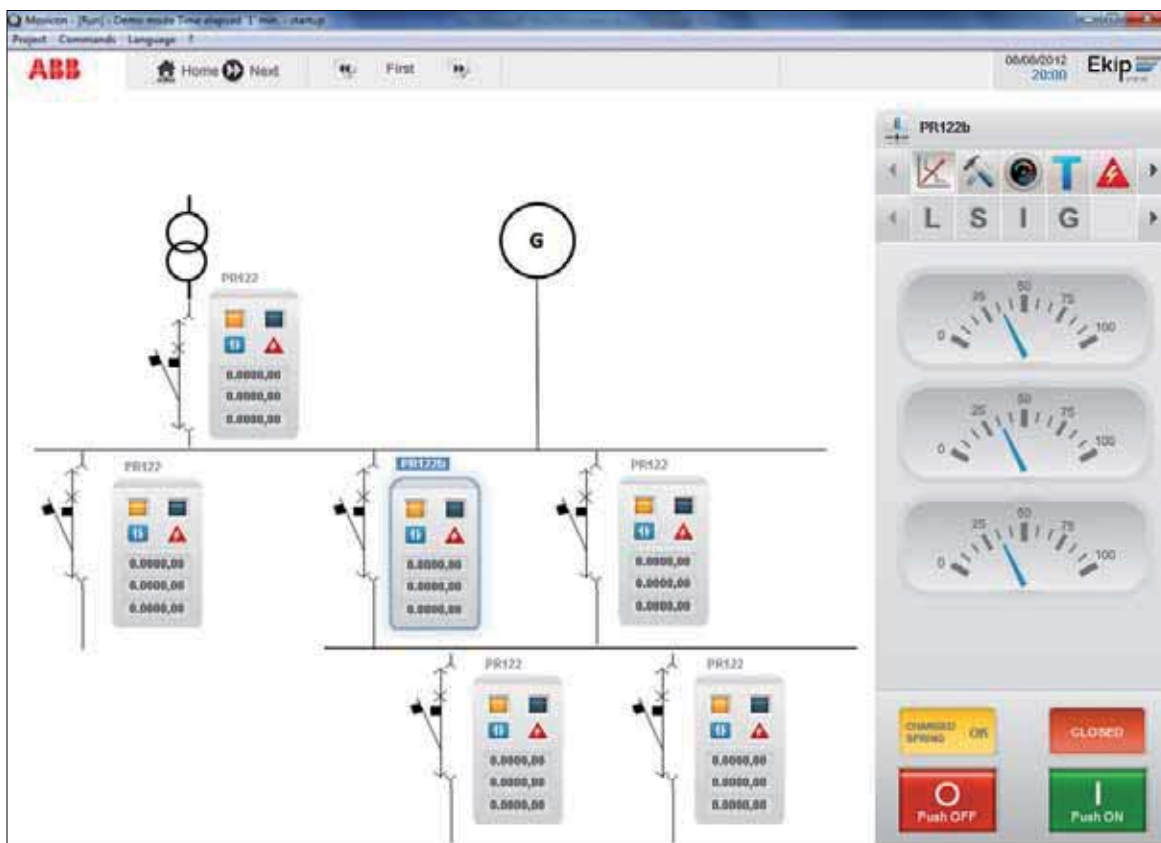

Ekip View Software		
Communication characteristics		
Protocol Supported	Modbus RTU	Modbus TCP
Physical layer	RS 485	EtherNet
Maximum data exchange rate	19200 bps	100 Mbps
Operating system	Windows XP, Windows 7, Windows Vista	
Devices supported		
SACE Emax 2 trip units	Ekip com Modbus RS485	Ekip com Modbus TCP
SACE Emax,T7,X1,T8 trip units	PR120/D-M, PR330/D-M	-
SACE Tmax T trip units	PR222DS/PD, PR223DS	-
SACE Tmax XT trip units	Ekip com	-
Third party devices	optional ¹⁾	optional ¹⁾
Licences available	- up to 30 ²⁾ controllable devices - up to 60 ²⁾ controllable devices - unlimited number ³⁾ controllable devices	- up to 30 ²⁾ controllable devices - up to 60 ²⁾ controllable devices - unlimited number ³⁾ controllable devices
Supervision and control functions		
Opening and Closing of circuit-breakers ⁴⁾	•	•
Electrical value trends	•	•
Log of electrical value trends	•	•
Dynamic installation mimic panel	•	•
Automatic scanning	•	•
Centralized synchronizing of time	•	•
Web server function	• ⁵⁾	• ⁵⁾
Redundancy	optional	optional
OPC server-client	optional	optional
Measurement functions ⁶⁾		
Currents	•	•
Voltages	•	•
Powers	•	•
Energies	•	•
Harmonics	•	•
Network analyzer	•	•
Data logger	•	•
Adjustment functions		
Setting of thresholds	•	•
Resetting of alarms	•	•
Diagnostics		
Protection function alarms	•	•
Device alarms	•	•
Communication system alarms	•	•
Protection unit tripping details	•	•
Events log	•	•
Protection unit tripping log	•	•
Generation of Reports	•	•
Transmission of alarms via SMS	optional	optional
Transmission of alarms via e-mail	optional	optional
Maintenance		
Number of operations	•	•
Number of trips	•	•
Wear of contacts	•	•
Other data		
Status of circuit-breaker	•	•
Circuit-breaker position ⁷⁾	•	•
local/remote mode	•	•

1) Contact ABB SACE to integrate other devices in the Ekip View software

2) can be increased

3) within the physical limit of the protocol used

4) circuit-breakers equipped with Ekip com Actuator module and electrical accessories

5) two client web accesses included in the licence, optional up to 5 accesses

6) according to the values supported by the trip units

7) circuit-breakers equipped with auxiliary contacts for position indication

Communication devices and systems

Supervision and control software

Ekip T&P Interface

The Ekip T&P Interface software, used together with the Ekip T&P device, enables the electronic protection trip units to be tested for correct operation during the stages of commissioning and system maintenance.

As a result of advanced graphical interfaces, the user can simply select the test to perform: from simple current and voltage signals to more complex wave forms with the presence of harmonic distortion.

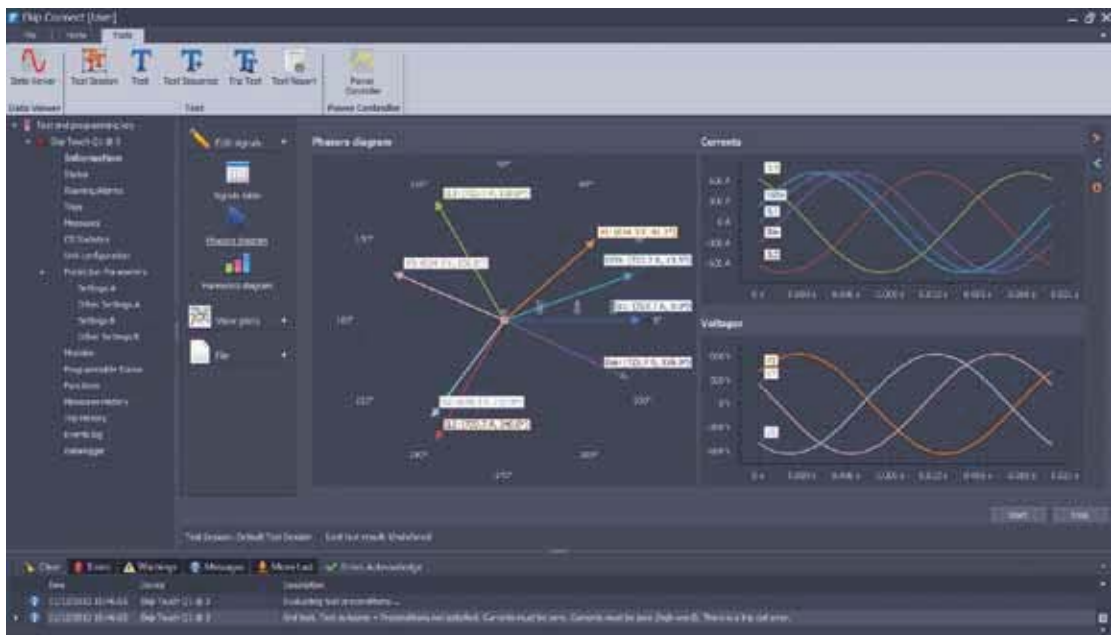

The software creates and stores all reports, keeping a record of the tests carried out and essential information such as the operator name, date, serial number of the circuit-breaker, type of test and the result.

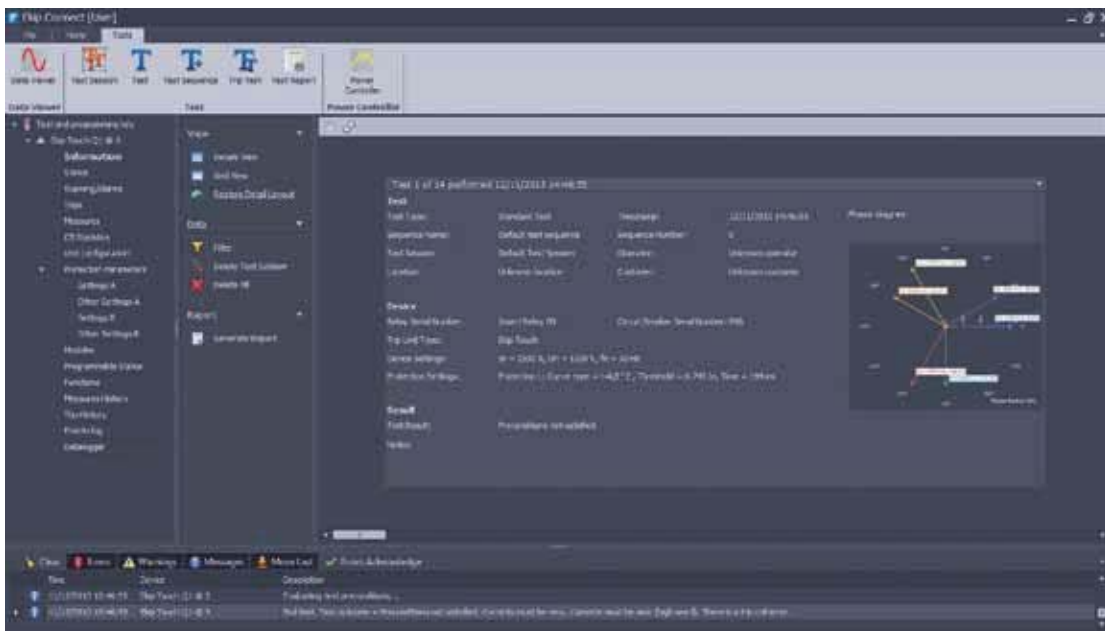

Accessories

Functional areas	5/2
Standard supply	5/4
Accessories for circuit-breakers	5/6
Signalling	5/7
Control	5/10
Safety	5/15
Protection devices	5/16
Connections	5/18
Interlocks and switching devices	5/20
Accessories for Ekip trip units	5/23
Power supply	5/25
Connectivity	5/25
Signalling	5/27
Measurements and protection	5/28
Displaying and supervision	5/32
Testing and programming	5/33
Spare parts	5/34

Accessories

Functional areas

The new SACE Emax 2 circuit-breakers have been designed to optimize the installation and commissioning of accessories.

The front of the circuit-breaker features two functional areas, which are protected by separate covers:

- **Accessories area** for the installation of accessories inside the circuit-breaker and Ekip trip unit. The areas dedicated to accessories can be accessed by removing the flange and the accessories covers. On removal, the operating mechanism area remains segregated and protected, providing safety for operators.
- **Safety area**, which delimits the housing of the stored energy operating mechanism of the circuit-breaker. To carry out maintenance on the operating mechanism, the covers of the accessories and safety area must be removed.

5



As a result of two distinct functional areas that determine the operating spaces, the accessorizing logic of the circuit-breakers has been considerably simplified.

The auxiliary connection terminal box also features two areas:

- **Terminal area** for housing and inserting the terminals for wiring the auxiliary connections. The terminals can be wired first and then installed on the circuit-breaker terminal box, thereby facilitating cable connection for the operator.
- **Cartridge module area**, housing for the Ekip modules. These are installed directly on the upper part of the circuit-breaker or of the fixed part without having to remove the Ekip electronic trip unit, thereby minimizing the time required for the installation and commissioning of accessories.

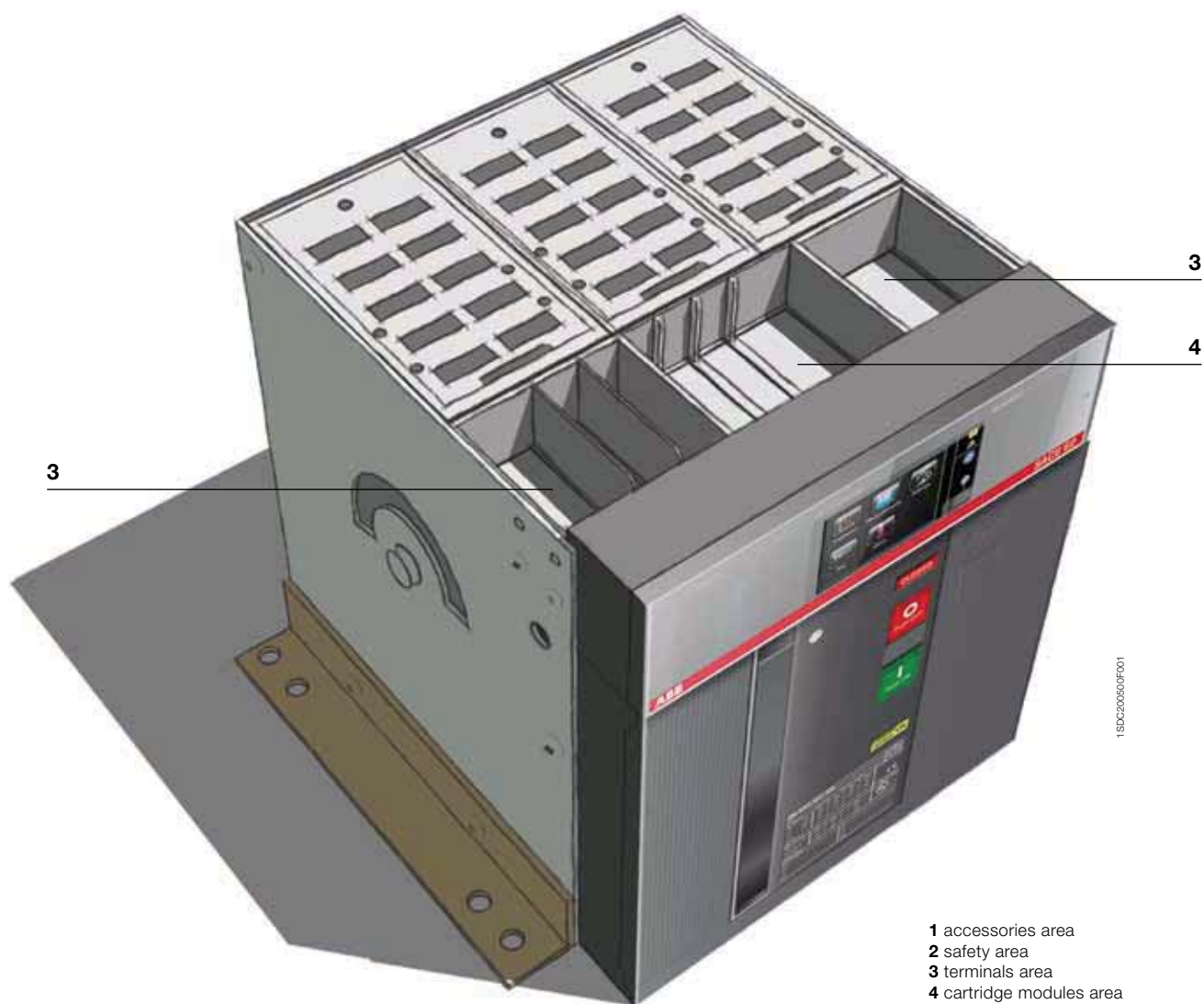

Accessories

Standard supply

The fixed versions of SACE Emax 2 automatic circuit-breakers and switch-disconnectors are always supplied as standard with the following accessories:

- IP30 protection for switchgear door
- lifting plates for E2.2 ... E6.2 circuit-breaker
- front terminals for E1.2 circuit-breaker
- adjustable rear terminals for E2.2 ... E6.2 circuit-breaker, mounted in HR – HR configuration.

In addition, for fixed automatic circuit-breakers only:

- four standard open/closed auxiliary contacts - AUX 4Q 400V
- four terminals for auxiliary connections
- mechanical signalling of the tripping of the protection trip unit - TU Reset
- Ekip TT power supply and test unit, when a protection trip unit is present with display
- contact signalling tripping of Ekip protection trip unit S51 250V.

5

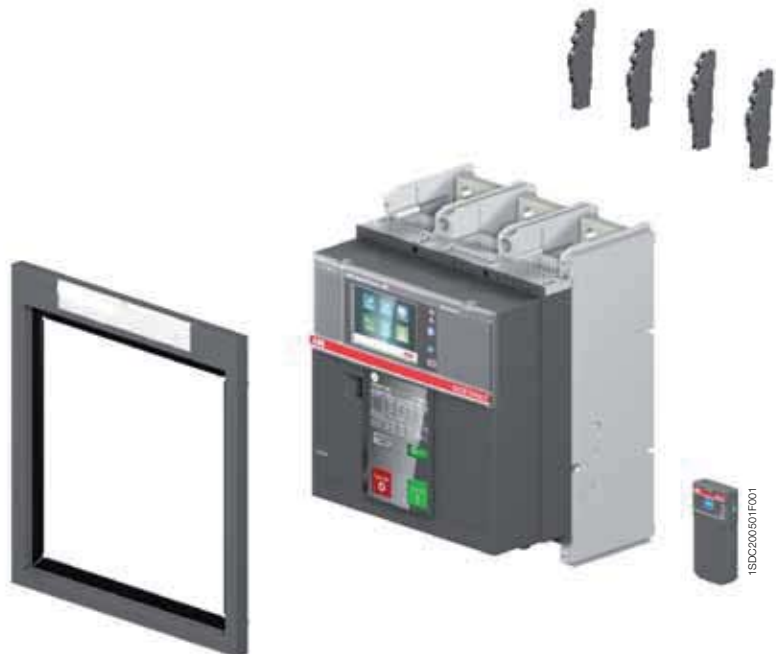

The withdrawable versions of automatic circuit-breakers and switch-disconnectors are always supplied as standard with the following accessories:

- closed circuit-breaker racked-out mechanism lock
- lifting plates for E2.2 ... E2.6 circuit-breakers
- lever for racking in and racking out
- anti-insertion lock.

In addition, for withdrawable automatic circuit-breakers only:

- four standard open/closed auxiliary contacts - AUX 4Q 400V
- four terminals for auxiliary connections
- mechanical signalling of the tripping of the protection trip unit - TU Reset
- Ekip TT power supply and test unit, when a protection trip unit is present with display
- contact signalling tripping of Ekip protection trip unit S51 250V.

The fixed parts feature:

- IP30 protection for switchgear door
- anti-insertion lock
- standard shutter lock – SL
- adjustable rear terminals, mounted in HR – HR configuration.



Accessories

Accessories for circuit-breakers

SACE Emax 2 circuit-breakers offer a wide range of accessories developed to satisfy the application and installation requirements of every customer.

	Automatic circuit-breaker		Switch-disconnector		Derived versions		
	E1.2	E2.2 - E4.2 - E6.2	E1.2	E2.2 - E4.2 - E6.2	CS E2.2 - E4.2 - E6.2	MT	MTP
Signalling							
Standard open/closed auxiliary contacts - AUX 4Q	● / ●●	● / ●●	○ / ○○	○ / ○○	-	-	-
Open/closed auxiliary contacts - AUX 6Q	-	○ / ○○	-	○ / ○○	-	-	-
Open/closed auxiliary contacts- AUX 15Q	○ / ○○	○ / ○○	○ / ○○	○ / ○○	-	-	-
Auxiliary position contacts - AUP	●	●	●	●	●	●	●
Ready to close signalling contact - RTC	○ / ○○	○ / ○○	○ / ○○	○ / ○○	-	-	-
TU Reset mechanical signalling of the tripping of protection trip unit - TU Reset	● / ●●	● / ●●	-	-	-	-	-
Contact signalling tripping of Ekip protection trip unit - S51	● / ●●	● / ●●	-	-	-	-	-
Contact signalling loaded springs – S33 M/2 (supplied with Motor)	○ / ○○	○ / ○○	○ / ○○	○ / ○○	-	-	-
Control							
Opening and closing release - YO/YC	○ / ○○	○ / ○○	○ / ○○	○ / ○○	-	-	-
Second opening and closing release - YO2/YC2	○ / ○○	○ / ○○	○ / ○○	○ / ○○	-	-	-
Undervoltage release - YU	○ / ○○	○ / ○○	○ / ○○	○ / ○○	-	-	-
Electronic time-delay device for undervoltage release - UVD	○ / ○○	○ / ○○	○ / ○○	○ / ○○	-	-	-
Motor - M	○ / ○○	○ / ○○	○ / ○○	○ / ○○	-	-	-
Remote reset - YR	○ / ○○	○ / ○○	-	-	-	-	-
Opening and closing release test unit - YO/YC Test Unit	○ / ●	○ / ●	○ / ●	○ / ●	-	-	●
Safety							
Key lock and padlock in open position - KLC and PLC	○ / ○○	○ / ○○	○ / ○○	○ / ○○	-	-	-
Key lock and padlock in racked-in / test / racked-out position - KLP and PLP	●	○○	●	○○	○○	○○	○○
Shutter lock - SL	●	●	●	●	●	●	●
External shutter lock - SLE	-	●	-	●	-	-	-
Lock for racking-out mechanism with circuit-breaker in closed position	●	●●	●	●●	-	-	●●
Lock for racking in / racking out the mobile part when the door is open - DLR	-	●	-	●	-	-	○○
Lock to prevent door opening when circuit-breaker is in racked-in / test position - DLP	-	●	-	●	-	-	●
Lock to prevent door opening when circuit-breaker is in closed position - DLC	○ / ○○	○ / ○○	○ / ○○	○ / ○○	-	-	○○
Anti-insertion lock	● / ●●	● / ●●	● / ●●	● / ●●	-	-	●●
Mechanical operation counter - MOC	○ / ○○	○ / ○○	○ / ○○	○ / ○○	-	-	○○
Protection devices							
Protection device for opening and closing pushbuttons - PBC	○ / ○○	○ / ○○	○ / ○○	○ / ○○	-	-	○○
IP30 Protection	● / ●	● / ●	● / ●	● / ●	-	-	● / ●
IP54 Protection	○ / ●	○ / ●	○ / ●	○ / ●	-	-	●
Terminal covers - HTC / LTC	○ / ○○	-	-	-	-	-	-
Separators - PB	○ / ○○	-	-	-	-	-	-
Connections							
Orientable rear terminal - HR/VR	○	●	○	●	-	-	●
Front terminal - F	●	○	●	○	-	-	○
Other configurations	○ / ●	○ / ●	○ / ●	○ / ●	-	-	●
Interlocks and switching devices							
Mechanical interlock - MI	○ / ○○ / ●	○ / ○○ / ●	○ / ○○ / ●	○ / ○○ / ●	-	-	○○
Automatic transfer switches - ATS	○ / ○○	○ / ○○	○ / ○○	○ / ○○	-	-	○○

- Standard accessory for fixed circuit-breaker
- Accessory on request for fixed circuit-breaker
- Standard accessory for mobile part
- Accessory on request for mobile part
- Standard accessory for fixed part
- Accessory on request for fixed part



1SDC2000303F001

Signalling

Open / closed auxiliary contacts - AUX

SACE Emax 2 circuit-breakers can be equipped with auxiliary contacts that signal the open or closed status of the circuit-breaker. The first block of four standard contacts is always provided with the automatic circuit-breakers. The switching contacts are available in the following configurations:



1SDC200504F001



1SDC200505F001

Open / closed auxiliary contacts (AUX 4Q)		E1.2	E2.2 ... E6.2
4 auxiliary contacts	standard	•	•
	digital signals	•	•
	mixed	•	•
Open / closed supplementary auxiliary contacts (AUX 6Q)			
6 auxiliary contacts	standard	-	•
	digital signals	-	•
	mixed	-	•
Open / closed external supplementary auxiliary contacts (AUX 15Q)			
15 auxiliary contacts	standard	•	•
	digital signals	•	•
Maximum number of open / closed auxiliary contacts that can be installed		19	25

		Standard contact	Contact for digital signals
Type		changeover contacts	changeover contacts
Minimum load		100mA @ 24V	1mA @ 5V
Breaking capacity			
DC	24V	-	0,1A
	125V	0,3A @ 0ms	-
	250V	0,15A @ 0ms	-
AC	250V	5A @ cosφ 1	-
		5A @ cosφ 0,7	-
		5A @ cosφ 0,3	-
	400V	3A @ cosφ 1	-
		2A @ cosφ 0,7	-
		1A @ cosφ 0,3	-

Electrical diagram reference: figure 1, 81, 91

Aux 6Q is an alternative to the Ekip Signalling 4K module. AUX 15Q is an alternative to the mechanical interlock (MI), the DLC for E1.2 lock or the DLP lock if mounted on the right side.

Accessories

Accessories for circuit-breakers

5



1SDC200506F001



1SDC200507F001

Auxiliary position contacts - AUP

When the circuit-breaker is a withdrawable version, the position of the mobile part can be signalled electrically by accessorizing the fixed part with one of the following signalling contact units:

Auxiliary position contacts (AUP)		E1.2	E2.2 ... E6.2
6 auxiliary contacts	standard	•	-
	digital signals	•	-
5 auxiliary contacts	standard	-	•
	digital signals	-	•
5 supplementary auxiliary contacts	standard	-	•
	digital signals	-	•
Maximum number of auxiliary position contacts that can be installed		6	10
		Standard contact	Contact for digital signals
Type		changeover contacts	changeover contacts
Minimum load		100mA @ 24V	1mA @ 5V
Breaking capacity			
DC	24V	-	0.1A
	125V	0.3A @ 0ms	-
	250V	0.15A @ 0ms	-
AC	250V	5A @ cosφ 1	-
		5A @ cosφ 0.7	-
		5A @ cosφ 0.3	-
	400V	3A @ cosφ 1	-
		2A @ cosφ 0.7	-
		1A @ cosφ 0.3	-

Electrical diagram reference: figure 95, 96, 97



1SDC200508F001

Ready to close signalling contact - RTC

The ready to close signalling contact – RTC – indicates that the circuit-breaker is ready to receive the closing command. The circuit-breaker is ready to close when the following conditions have been met:

- circuit-breaker open
- springs loaded
- no opening command or locks on the opening command
- circuit-breaker reset following tripping of Ekip protection trip unit.

		Standard contact	Contact for digital signals
Type		Switching	
Minimum load		100mA @ 24V	1mA @ 5V
Breaking capacity			
DC	24V	-	0.1
	250V	0.5A @ 0ms / 0.2A 10ms	-
AC	250V	3A @ cosφ 0.7	-

Electrical diagram reference: figure 71



1SDC200068FF001

Mechanical signalling of the tripping of protection trip unit - TU Reset

The automatic circuit-breakers are always equipped with a mechanical device that signals the tripping status of the protection trip units. After the Ekip trip unit has tripped due to an electrical fault, the signalling device clearly indicates the tripping status on the front of the circuit-breaker. The circuit-breaker can be reset only after the signalling pushbutton has been restored to its normal operating position. The device conforms to the Ansi 86T standard.



1SDC200068FF001

Contact signalling tripping of protection trip unit Ekip – S51

The contact signals the opening of the circuit-breaker after the Ekip protection trip unit has tripped. The circuit-breaker can only be closed after the “TU Reset” tripped trip unit mechanical signalling pushbutton has been restored to its normal operating position. The switching contact, which is always supplied with the standard version of the automatic circuit-breakers, is also available on request in a version for digital signals (for electrical characteristics, please refer to the RTC contact). It can also be associated with an optional accessory for resetting by remote control - YR. For electromechanical characteristics, please refer to the RTC contact.

Electrical diagram reference: figure 11

Contact signalling loaded springs – S33 M/2

This contact is always supplied with a geared motor; it remotely signals the spring status of the circuit-breaker operating mechanism. It is available in both standard version and version for digital signals.

		Standard contact	Contact for digital signals
Type		changeover contacts	changeover contacts
Minimum load		100mA @ 24V	1mA @ 5V
Breaking capacity			
DC	24V	-	0.1A
	125V	0.3A @ 0ms	-
	250V	0.15A @ 0ms	-
AC	250V	5A @ cosφ 1	-
		5A @ cosφ 0.7	-
		5A @ cosφ 0.3	-
	400V	3A @ cosφ 1	-
		2A @ cosφ 0.7	-
		1A @ cosφ 0.3	-

Electrical diagram reference: figure 12

Accessories

Accessories for circuit-breakers



Control

Opening and closing release- YO/YC

The opening and closing releases enable the circuit-breaker to be controlled remotely. Opening is always possible, while closing is available only when the closing springs of the operating mechanism are loaded and the circuit-breakers is ready to close.

The releases operate by means of minimum impulse current duration time of 100 ms.

Furthermore, they can operate in permanent service. In this case, if opening command is given by means of the opening release, the circuit-breaker can be closed by de-energizing the opening release and, after a time of at least 30 ms, by controlling the closing.

Electrical diagram reference: figure 75, 77

Second opening and closing release - YO2/YC2

For certain installations the redundancy of mechanisms and circuit-breaker operating circuits is often requested. To answer these needs, the SACE Emax 2 circuit-breakers can be equipped with double opening release and double closing release. The technical characteristics of the second opening release remain the same as those of the first opening and closing release.

A double closing release can be used for E2.2, E4.2 and E6.2 circuit-breakers; a second close release in an alternative to undervoltage release.

Electrical diagram reference: figure 72, 79

General characteristics

Power supply (Un)	AC	DC
24V	•	•
30V	•	•
48V	•	•
60V	•	•
110V...120V	•	•
120V...127V	•	•
220V...240V	•	•
240V...250V	•	•
380V...400V	•	-
415V...440V	•	-
480V...500V	•	-
Operating limits (IEC60947-2 standards)	YO/YO2: 70%...110% Un YC/YC2: 85%...110% Un	
Inrush power (Ps)	300VA	300W
Continuous power (Pc)	3.5VA	3.5W
Opening time (YO/YO2)		
E1.2	35 ms	
E2.2 ... E6.2	35 ms	
Closing time (YC/YC2)		
E1.2	50 ms	
E2.2 ... E6.2	50 ms	

Opening and closing release test unit - YO/YC Test Unit

The opening and closing releases test unit helps ensure that the various version of releases are running smoothly, to guarantee a high level of reliability in controlling circuit-breaker opening. The test unit ensures the continuity of the opening and closing releases with a rated operating voltage between 24V and 250V (AC and DC), as well as verifies the functions of the opening and closing coil electronic circuit.

Continuity is checked cyclically with an interval of 20s between tests. The unit has optic signals via LEDs on the front, which provide the following information:

POWER ON: power supply present

TESTING: testing in progress

TEST FAILED: signal following a failed test or lack of auziliary power supply

ALARM: signal given following three failed tests.

Two relays with one change-over area also available on board the unit, to allow remote signalling of the following events:

Failure of a test - resetting takes place automatically when the alarm stops

Failure of three tests - resetting occurs only by pressing the manual RESET on the unit.

Characteristics of device

Auxiliary power supply	24V...250V AC/DC
Specification of the signalling relays	
Maximum interrupted current	6A
Maximum interrupted voltage	250V AC

Accessories

Accessories for circuit-breakers



1SDC200310F001

Undervoltage release – YU

The undervoltage release opens the circuit-breaker when there is a significant voltage drop or power failure. It can be used for safe remote tripping, for blocking closing or to control the voltage in the primary and secondary circuits. The power supply for the release is therefore obtained on the supply side of the circuit-breaker or from an independent source. Circuit-breaker closing is permitted only when the release is powered. The undervoltage release is an alternative to as second shunt trip or the anti-racking out device.

General characteristics

Power supply (Un)	AC	DC
24V	•	•
30V	•	•
48V	•	•
60V	•	•
110V...120V	•	•
120V...127V	•	•
220V...240V	•	•
240V...250V	•	-
380V...400V	•	-
415V...440V	•	-
480V...500V	•	-
Operating limits (IEC60947-2 standards)	70%...110% Un	
Inrush power (Ps)	300VA	300W
Continuous power (Pc)	3.5VA	3.5W
Opening time (YU)		
E1.2	30 ms	
E2.2 ... E6.2	50 ms	

Electrical diagram reference: figure 73

Time-delay device for undervoltage release (UVD)

The undervoltage release can be combined with an electronic time-delay device for the circuit-breaker, allowing for delayed external tripping with adjustable preset times. Use of the delayed undervoltage trip unit is recommended to prevent tripping when the power supply network for the trip unit is subject to brief voltage drops or power supply failures. Circuit-breaker closing is inhibited when it is not powered. The time-delay device must be used with an undervoltage release with the same voltage.

General characteristics

Power supply (UVD)	AC	DC
24-30V	-	•
48V	•	•
60V	•	•
110-127V	•	•
220-250V	•	•
Adjustable opening time (YU + D):	0.5-1-1.5-2-3 s	

5



Resetting remotely- YR

The reset coil YR permits remote resetting of the circuit-breaker after a release has tripped due to an overcurrent condition.

It is available for all automatic circuit-breakers, in different voltage supply:

General characteristics

Power supply (Un)	AC	DC
24V	•	•
110V	•	•
220V	•	•
Operating limits	90%...110% Un	

Electrical diagram reference: figure 14

Accessories

Accessories for circuit-breakers



5

Motor – M

The motor automatically loads the closing springs of the circuit-breaker. The device, which can be installed from the front, automatically reloads the springs of the operating device when they are unloaded and power is present. In the event no power is present, the springs can be manually loaded by a dedicated lever on the operating device. The motor is always supplied with the limit switch contact S33 M/2 which signals the status of the springs.

General characteristics

Power supply (Un)	AC	DC
24V-30V	•	•
48V-60V	•	•
100V...130V	•	•
220V...250V	•	•
380V...415V	•	-
440V...480V (E2.2 ... E6.2)	•	-
Operating limits (IEC60947-2 standards)	85%...110% Un	
Inrush power (Ps)	300VA E1.2 500VA E2.2 ... E6.2	300W E1.2 500W E2.2 ... E6.2
Inrush time	200ms	
Continuous power (Pc)	100VA E1.2 150VA E2.2 ... E6.2	100W E1.2 150W E2.2 ... E6.2
Charging time		
E1.2	8 sec	
E2.2 ... E6.2	7 sec	

Electrical diagram reference: figure 13



1SDC200515F001



1SDC200516F001



1SDC200517F001

1SDC200518F001



1SDC200519F001



1SDC200520F001



1SDC200521F001

Safety

Key lock in open position - KLC

Due to these safety devices, the SACE Emax 2 circuit-breaker can be locked in the open position. The lock can also be used during maintenance activities when the shield of the accessories area is removed. The device is available with lock with different keys – KLC-D (for only one circuit-breaker) or with the same keys – KLC-S (for several circuit-breakers). Four different key numbers are available for the KLC-S.

SACE Emax 2 also allows alternative key lock to be installed. The following key lock set-ups are also available:

- Ronis
- Profalux
- Kirk
- Castell

In this case, the key locks must be supplied by the customer.

Padlocks - PLC

These padlock options allow the circuit-breaker to be kept open by acting directly on the mechanical operating device (opening pushbutton). Three different padlock versions are available:

- Locking device with plastic structure for up to a maximum of three padlocks of 4 mm
- Locking device with metal structure for up to a maximum of two padlocks of 8 mm
- Locking device with metal structure for one padlock of 7 mm or for padlock holders

The padlocks must be supplied by the customer. This device is an alternative to the PBC.

Key lock in racked-in / test / racked-out position - KLP

This device enables the mobile part to be locked in one of the three positions: racked-in, test and racked-out.

This device can be supplied with locks with different keys – KLP-D or with the same keys – KLP-S. A second key lock option can be added for a maximum of two key locks per breaker. Locking in the racked-in, test and racked-out positions can be achieved by using other key locks – KLP-A. Adapters are offered for acceptance of Ronis, Profalux, Kirk and Castell locks, which are to be provided by the customer. With the exception of the Castell version, every circuit-breaker can accept up to two key locks. Moreover, it is possible to allow locking only when in the racked-out position with a supplementary accessory.

Padlock in racked-in / test / racked-out position - PLP

This device can hold up to three padlocks of 8 mm in diameter. The structure housing the padlocks can also be used in combination with the 2 lock KLP keylock option. Furthermore, it enables the lock of the moving part in the racked-out position only by means of the supplementary lock in racked-out position.

Shutter lock – SL

When the mobile part is in the test position, the shutters of the fixed part close, maintaining the insulation distance and physically segregating the live parts of the of the cradle from the internal breaker compartment of the cradle. Using two dedicated mechanisms, the upper and lower shutters can be locked independently of one another. The shutter lock is always supplied with the fixed part of the SACE Emax 2 circuit-breakers and locks the shutters, using a maximum of three padlocks of 4 mm, 6 mm or 8 mm.

Accessories

Accessories for circuit-breakers

5



Protection devices

External shutter lock - SLE

This accessory is optional and, using padlocks of 4 mm, 6 mm or 8 mm, allows the shutters to be locked directly from the outside of the fixed part, avoiding the need to work inside. For both lock versions, the padlocks are supplied by the customer.

Lock for racking-out mechanism with circuit-breaker in closed position

All SACE Emax 2 withdrawable circuit-breakers are always supplied with a lock that prevents the mobile part from being racked in and racked out when the circuit-breaker is in the closed position. To rack in the mobile part, the circuit-breaker must be in the open position.



Lock for racking in / racking out the mobile part when the door is open - DLR

This accessory, which is mounted on the fixed part, prevents the mobile part from being racked in or out when the switchgear door is open.



Lock to prevent door opening when the circuit-breaker is in racked-in / test position - DLP

This safety device prevents the switchgear door from being opened when the mobile part of the withdrawable version of the circuit-breaker is in the racked-in or test position. The circuit-breaker can only be racked in when the door is open, which is then closed. This accessory can be installed on either the right-hand or left-hand side of the fixed part. It is available for circuit-breakers E2.2, E4.2 and E6.2. If mounted on the right side, it is an alternative to the mechanical interlock, the AUX 15Q or the DLC.



Lock to prevent door opening when the circuit-breaker is in the closed position - DLC

This prevents the compartment door from being opened when the circuit-breaker is in the closed position (and with the circuit-breaker racked in for withdrawable circuit-breakers). It also blocks the circuit breaker from closing when the compartment door is open. DLC for E1.2 is an alternative to the mechanical interlock and the AUX 15Q. DLC direct door for E2.2...E6.2 is compatible with all mechanical interlocks and the AUX 15Q DLC. DLC cable door for E2.2...E6.2 is compatible with mechanical interlock type A and the AUX 15Q.

Anti-insertion lock

The withdrawable circuit-breakers are equipped with special locks that allow the mobile part to be inserted only into the corresponding fixed part.



Mechanical operation counter - MOC

The number of mechanical operations is often one of the elements that determines the frequency of ordinary maintenance operations on circuit-breakers. With this mechanical operation counter, which is always visible on the front of the circuit-breaker, the user knows how many mechanical operations the device has performed.

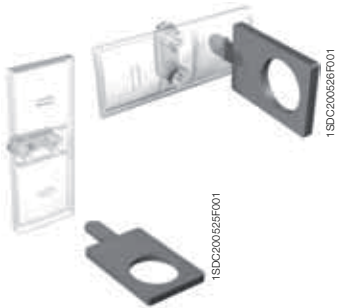

Protection device for opening and closing pushbuttons - PBC

This accessory is applied to the safety cover of the circuit-breaker and is available in two versions:

- Pushbutton protection device, which blocks operations on both the opening and closing pushbuttons unless the special key is used.
- Padlockable pushbutton protection device, which makes it possible to block either or both pushbuttons and lock the covers in place. It does not trip the breaker as a standard "Padlock device" would.
- PBC is an alternative to PLC padlocks.



IP30 Protection

Supplied with every circuit-breaker, the cover frame is installed on the door of the switchgear to achieve IP30 degree of protection on the front part of the circuit-breaker.



IP54 Protection

This transparent cover completely protects the front of the circuit-breaker, enabling an IP54 degree of protection to be achieved. This accessory is provided with double key lock (same or different keys).



Terminal covers – HTC / LTC

These accessories are installed over in the terminal area, thereby reducing the risk of direct contact with the live parts of the circuit-breaker. Two versions are available for E1.2: HTC high terminal covers and LTC low terminal covers.



Separators - PB

These protection devices increase the insulation distance between adjacent phases. They are available for all the frames.

Accessories

Accessories for circuit-breakers

Connections

The SACE Emax 2 circuit-breakers offer a wide variety of terminals, thereby always guaranteeing an optimal solution for connection to the power circuit.

Solution for fixed circuit-breakers

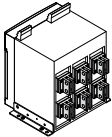
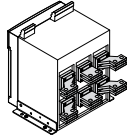
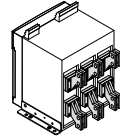
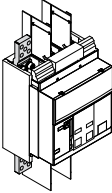
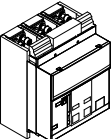
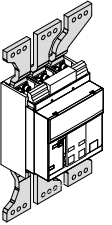
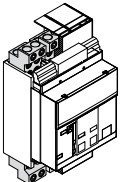
Type	Abbreviation		E1.2	E2.2	E4.2	E6.2
Rear adjustable terminal *	HR VR		Single stab design			
			○	● Iu = 2000A	● Iu = 3200A	● Iu = 5000A
Horizontal rear spread terminal	SHR		Multiple stab design			
				● Iu = 2500A	● Iu = 4000A	● Iu = 6300A
Vertical rear spread terminal	SVR			○		
Extended front terminal	EF		○			
Front terminal	F		●	○	○	○
Front spread terminal	ES		○			
Terminal for cable FcCuAl 4x240mm ²	FcCuAl		○			

- Standard configuration
- Configuration on request

(*) The adjustable terminals are supplied as standard in the HR – HR configuration.

Solutions for fixed parts, withdrawable circuit-breakers

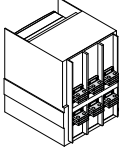
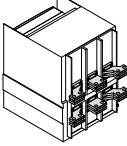
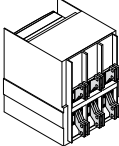
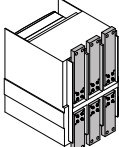
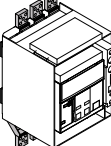
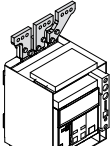
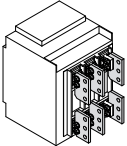
Type	Abbreviation		E1.2	E2.2	E4.2	E6.2
Rear adjustable terminal *	HR VR		Single stab design			
			●	● Iu = 2000A	● Iu = 3200A	● Iu = 5000A
Horizontal rear terminal	SHR		Multiple stab design			
				● Iu = 2500A	● Iu = 4000A ○ Iu = 3200A**	● Iu = 6300A or X performance
Vertical rear spread terminal	SVR			○		
Front terminal	F			○	○	○
Extended front terminal	EF		○			
Front spread terminal	ES		○			
Terminal for cable FcCuAl 4x240mm ²	Fc CuAl		○			
Flat terminal	FL			○	○	○

● Standard configuration

○ Configuration on request

(*) The adjustable terminals are supplied as standard in the HR – HR configuration.

(**) Fixed parts with Iu 3200A accessorized with rear orientable terminals with multiple stabs guarantee higher performances in switchboard installations.

Accessories

Accessories for circuit-breakers

Interlocks and switching devices

Mechanical interlocks

These interlock systems enable various opening and closing configurations to be obtained between two or three circuit-breakers. Four types of interlock configuration are available:

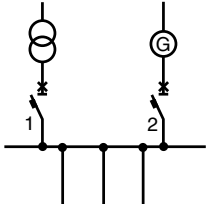
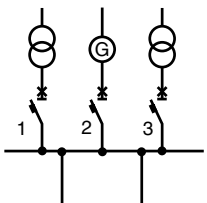
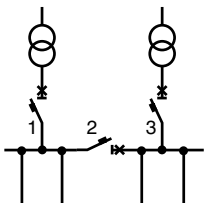
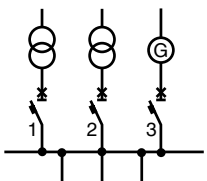
Types of interlock	Possible application	Logic	Circuit-breakers																								
Type A Excludes the possibility of having two circuit-breakers in the closed position at the same time.	Main line power supply and emergency power supply. 	<table border="1"> <tr> <td>1</td> <td>2</td> </tr> <tr> <td>O</td> <td>O</td> </tr> <tr> <td>I</td> <td>O</td> </tr> <tr> <td>O</td> <td>I</td> </tr> </table>	1	2	O	O	I	O	O	I	Available between circuit-breakers of different sizes and with any fixed / withdrawable version																
1	2																										
O	O																										
I	O																										
O	I																										
Type B Permits a pair of circuit-breakers to be closed if the third is open. The latter can only be closed when the pair is open.	Two power supplies from transformers and one emergency power supply. 	<table border="1"> <tr> <td>1</td> <td>2</td> <td>3</td> </tr> <tr> <td>O</td> <td>O</td> <td>O</td> </tr> <tr> <td>I</td> <td>O</td> <td>O</td> </tr> <tr> <td>O</td> <td>O</td> <td>I</td> </tr> <tr> <td>I</td> <td>O</td> <td>I</td> </tr> <tr> <td>O</td> <td>I</td> <td>O</td> </tr> </table>	1	2	3	O	O	O	I	O	O	O	O	I	I	O	I	O	I	O	Available between E2.2, E4.2 and E6.2 circuit-breakers and with any fixed / withdrawable version						
1	2	3																									
O	O	O																									
I	O	O																									
O	O	I																									
I	O	I																									
O	I	O																									
Type C Permits two out of three circuit-breakers to be closed at the same time.	Two half-busbars can be powered by a single transformer (bus-tie closed) or by both at the same time (bus-tie open). 	<table border="1"> <tr> <td>1</td> <td>2</td> <td>3</td> </tr> <tr> <td>O</td> <td>O</td> <td>O</td> </tr> <tr> <td>I</td> <td>O</td> <td>O</td> </tr> <tr> <td>O</td> <td>I</td> <td>O</td> </tr> <tr> <td>O</td> <td>O</td> <td>I</td> </tr> <tr> <td>O</td> <td>I</td> <td>I</td> </tr> <tr> <td>I</td> <td>I</td> <td>O</td> </tr> <tr> <td>I</td> <td>O</td> <td>I</td> </tr> </table>	1	2	3	O	O	O	I	O	O	O	I	O	O	O	I	O	I	I	I	I	O	I	O	I	Available between E2.2, E4.2 and E6.2 circuit-breakers and with any fixed / withdrawable version
1	2	3																									
O	O	O																									
I	O	O																									
O	I	O																									
O	O	I																									
O	I	I																									
I	I	O																									
I	O	I																									
Type D Permits one out of three interlocked circuit-breakers to be closed.	Three power supplies on the same busbar that must not operate in parallel. 	<table border="1"> <tr> <td>1</td> <td>2</td> <td>3</td> </tr> <tr> <td>O</td> <td>O</td> <td>O</td> </tr> <tr> <td>I</td> <td>O</td> <td>O</td> </tr> <tr> <td>O</td> <td>I</td> <td>O</td> </tr> <tr> <td>O</td> <td>O</td> <td>I</td> </tr> </table>	1	2	3	O	O	O	I	O	O	O	I	O	O	O	I	Available between E2.2, E4.2 and E6.2 circuit-breakers and with any fixed / withdrawable version									
1	2	3																									
O	O	O																									
I	O	O																									
O	I	O																									
O	O	I																									

The mechanical interlocks offer multiple solutions for installation that simplify their integration into the switchgear. The interlocks can be mounted:

- vertically **VR**
- horizontally **HR**
- mixed **L**

Different types of interlocks can be supplied according to the maximum distance between two interlocked breakers:

Configuration		Type A	Type B, C, D
Horizontal		2750mm	1600mm
Vertical		1000mm	1000mm
Breakers	E1.2	•	-
	E2.2	•	•
	E4.2	•	•
	E6.2	•	•

For B, C and D types, the maximum distance between the two furthest breakers is 3200mm for horizontal configurations and 2000mm for vertical configurations. All cables can be cut to guarantee easy installation in switchboards. Mechanical interlocks are not compatible with AUX 15Q, the lock for preventing door opening when the circuit breaker is in the closed position (DLC) or when the circuit breaker is in the racked in or test position (DLP), if mounted on the right side.

Automatic Transfer Switches ATS

The ATS (Automatic Transfer Switch) is a network-unit transfer device used in installations where switching from the main power line to an emergency line is required in order to ensure that power is supplied to the loads in the case of power loss or abnormalities from the main line. These devices are able to control the entire transfer procedure automatically, but also offer commands for performing the procedure manually. In the event of loss of or anomalies in the main line voltage, the opening of the main line circuit-breaker, the starting of the generator set (if present) and the closing of the emergency line are activated according to the parameters set by the user. In the same way, when the main line returns to normal, the reverse transfer procedure is performed automatically.

The new generation of ATSs (ATS021 and ATS022) offers the most advanced and complete solution for ensuring service continuity. The ATS021 and ATS022 devices can also be used with all automatic circuit-breakers and switch-disconnectors of the Tmax XT family. The ATS021 and ATS022 devices have been designed to be self-powered. ATS022 is also designed for the connection of an auxiliary supply, which enables the use of further functions.

The ATS021 and ATS022 devices carry out control of both power supply lines and also analyze:

- phase imbalance;
- frequency imbalance;
- phase loss.

In addition to the standard control functions, the ATS022 unit also permits:

- the priority line to be selected;
- a third circuit-breaker to be controlled;
- the device to be integrated into a supervision system with Modbus communication (auxiliary supply needed);
- parameters to be read and set, and measurements and alarms to be displayed by means of a graphical display.

Typical applications are: supply of UPS (Uninterrupted Power Supply) units, operating rooms and primary hospital services, emergency power for civil buildings, airports, hotels, databases and telecommunication systems and power supply of industrial lines in continuous processes.

For correct configuration, each circuit-breaker connected to the ATS021 or ATS022 device must be fitted with the following accessories:

- mechanical interlock;
- motorized control of opening and closing;
- contact for signalling status (open / closed) and contact for signalling tripping;
- contact for signalling circuit-breaker racked in (for withdrawable circuit-breaker).

Accessories

Accessories for circuit-breakers



Technical characteristics

		ATS021	ATS022	
General	Auxiliary supply voltage	Not required	Not required (24-110V DC is required only for Modbus communication and systems of 16 2/3 Hz)	
	Supply voltage, Un	Max 480V AC	Max 480V AC	
	Frequency, fn	50, 60 Hz	16 2/3, 50, 60, 400 Hz	
	Dimensions 	H mm	96	96
		W mm	144	144
		D mm	170	170
Type of installation	Installation on front of switchgear Installation on DIN rail	Installation on front of switchgear Installation on DIN rail		
Operating mode	Automatic/Manual	Automatic/Manual		
Characteristics	Monitoring of normal and emergency line	•	•	
	Control of circuit-breakers on normal and emergency line	•	•	
	Setting start-up of generator	•	•	
	Setting switch-off of generator with settable time delay	•	•	
	Third circuit-breaker	-	•	
	Selection priority line	-	•	
	Modbus Rs485 communication	-	•	
	Display	-	•	
Environmental conditions	Protection degree	IP20	IP20	
	Operating temperature	-20 ... +60 °C	-20 ... +60 °C	
	Humidity	5% - 90% without condensation	5% - 90% without condensation	
Operating thresholds	Undervoltage	-30% ... -5% Un	-30% ... -5% Un	
	Overvoltage	+5% ... +30% Un	+5% ... +30% Un	
	Frequency thresholds	-10% / +10% fn	-10% ... +10% fn	
Tests	Test Mode	•	•	
	Mode Test Gen set	•	•	
Standards	Electronic devices for use in electrical installations	EN-IEC 50178	EN-IEC 50178	
	Electromagnetic compatibility	EN 50081-2	EN 50081-2	
		EN 50082-2	EN 50082-2	
	Environmental conditions	IEC 68-2-1	IEC 68-2-1	
IEC 68-2-2		IEC 68-2-2		
IEC 68-2-3		IEC 68-2-3		

Electrical diagram reference: figures 100,101 and 102.

Accessories

Accessories for Ekip trip units

The electronic trip unit accessories enable utilization of all the potential of Ekip protection trip units in terms of signalling, connectivity, protection functions and testing.

	Electronic trip unit				
	Ekip DIP	Ekip Touch	Ekip Hi-Touch	Ekip G Touch	Ekip G Hi-Touch
Power supply					
Ekip Supply	○	○	○	○	○
Battery for Ekip trip units	○	○	○	○	○
Connectivity					
Ekip Com		○	○	○	○
Ekip Com Redundant		○	○	○	○
Ekip Com Actuator	○	○	○	○	○
Ekip Link	○	○	○	○	○
Ekip Bluetooth	○	○	○	○	○
Signalling					
Ekip Signalling 2K		○	○	○	○
Ekip Signalling 4K ⁽¹⁾		○	○	○	○
Ekip Signalling 10K	○	○	○	○	○
Ekip Power Controller		○	○	○	○
Measurement and Protection					
Ekip Measuring Pro		○	●	●	●
Ekip Measuring		○			
Ekip AUP	○	○	○	○	○
Ekip RTC	○	○	○	○	○
Ekip Synchrocheck		○	○	○	○
Ekip LCD		○	○	○	○
Rating Plug	○	○	○	○	○
Homopolar toroid		○	○	○	○
Toroid for differential protection		○	○	○	○
Current sensor for neutral conductor outside the circuit-breaker	○	○	○	○	○
Displaying and Supervision					
Ekip Multimeter	○	○	○	○	○
Ekip Control Panel	○	○	○	○	○
Testing and Programming					
Ekip TT	○	●	●	●	●
Ekip T&P	○	○	○	○	○
Ekip T&P: Ekip Programming	○	○	○	○	○

- Standard accessory
- Accessory on request
- ⁽¹⁾ not available for E1.2

Accessories

Accessories for Ekip trip units

All accessories are automatically recognized by the Ekip units without the need for any specific configuration. Based on the installation method and connection of the trip units, the electronic accessories can be divided into:

Installation	Modules	Highlights
Terminal box	Cartridge modules: Ekip Com Ekip Link Ekip 2K Ekip Supply Ekip Synchrocheck	- The Ekip Supply module enables the trip units to be supplied with a wide range of control voltages
		- the Ekip supply module must be present for the other modules to be used
5 Accessorizing area	Ekip LCD Ekip Com Actuator Ekip RTC Ekip AUP Ekip Measuring Ekip Signalling 4K Rating Plug Battery for Ekip	- The Ekip Supply module has a dedicated position in the installation area in the terminal box; the other modules can be installed as desired in the positions available
		- When fitted with the Ekip Supply module, up to 2 additional modules can be installed on E1.2, and up to 3 on E2.2, E4.2 and E6.2
Ekip trip unit test port	Ekip T&P Ekip TT Ekip Bluetooth	- These are installed in specific housings from the front of the circuit-breaker
		- For all the trip units with a touch screen interface, an LCD version is available with any adjustment in the protection and measurements functions
External	Ekip Multimeter Ekip Control Panel Ekip 10K External neutral sensor Homopolar toroid Differential toroid	- Thanks to the optional modules Ekip RTC and Ekip AUP, all the Ekip trip units can acquire and monitor the ready to close state and the racked-in/ test isolated/racked-out position of the circuit-breaker. The module to acquire the open/closed position is supplied as standard for all Ekip trip units.
		- The Ekip Signalling 4k module increases the remote signalling possibilities for E2.2, E4.2 and E6.2 and can be installed if the Ekip Supply module or another 24V auxiliary power supply is present
		- These can be connected to the front test port of the trip units even with the device in operation
		- Compatible also with the SACE Tmax XT range
		- Ekip Multimeter can supply a 24V DC output to the trip unit it is connected to
		- Several Ekip units and / or Ekip Signalling 10K can be connected at the same time to the same Ekip trip unit
		- These are connected to the trip unit by the terminal box of the circuit-breaker



Power supply

Ekip Supply Power Supply module

The Ekip Supply module supplies all Ekip trip units and modules present on the terminal box and of the circuit-breaker with several auxiliary power (in AC or DC) available in the switchgear. The module is mounted in the terminal box and permits the installation of the other advanced modules. It can be field installed at any time.

Two versions are available according to the control voltage available:

- Ekip Supply 110-240V AC/DC
- Ekip Supply 24-48V DC

Electrical diagram reference: figures 31, 32



Connectivity

The Ekip Com modules enable all SACE Emax 2 circuit-breakers to be integrated in an industrial communication network for remote supervision and control of the circuit-breaker. They are suitable for all distribution and generator protection versions of the Ekip Touch and Hi-Touch trip units.

Since they are mounted in the terminal box, communication can be maintained with withdrawable circuit-breakers, even while in the racked-out position.

Several Ekip Com modules can be installed at the same time, thereby enabling connection to communication systems that use different protocols.

The Ekip Com modules for Modbus RTU, Profibus-DP and DeviceNet contain a terminating resistor and dip switch for optional activation to terminate the serial network or bus. The Profibus-DP module also contains a polarization resistor and dip switch for its activation.

The Ekip Com modules are supplied complete with auxiliary position contacts Ekip AUP and ready to close circuit-breaker contacts Ekip RTC.

For industrial applications where superior reliability of the communication network is required, the Ekip Com R communication modules, installed together with the corresponding Ekip Com modules, guarantee redundant connection to the network.

The Ekip Com modules enable Ekip trip units to be connected to networks that use the following protocols:

Protocol	Ekip Com Module	Ekip Com Redundant Module
Modbus RTU	Ekip Com Modbus RS-485	Ekip Com R Modbus RS-485
Modbus TCP	Ekip Com Modbus TCP	Ekip com R Modbus TCP
Profibus-DP	Ekip Com Profibus	Ekip Com R Profibus
Profinet	Ekip Com Profinet	Ekip Com R Profinet
EtherNet / IP	Ekip Com EtherNet / IP	Ekip Com R EtherNet / IP
DeviceNet	Ekip Com DeviceNet	Ekip Com R DeviceNet
IEC61850	Ekip Com IEC61850	-

Electrical diagram reference: figures from 51 to 57. Redundant version from 61 to 66.

Accessories

Accessories for Ekip trip units



Ekip Link Module

The Ekip Link module enables the SACE Emax 2 circuit-breaker to be connected to ABB communication system for locally supervising switchgear by means of the Ekip Control Panel and to act as Power Controller. It is suitable for all Ekip trip units and can be factory or field installed in time to the circuit-breaker terminal box, even when Ekip Com communication modules are present. In this way, it is possible to have both local supervision of the control panel by means of the Ekip Control Panel and supervision of the system by means of the Ekip Com modules connected to the communication network.

The Ekip Link modules are supplied complete with auxiliary position contacts Ekip AUP and ready to close circuit-breaker contacts Ekip RTC.

Electrical diagram reference: figure 58

5



Ekip Com Actuator module

The Ekip Com Actuator module enables the SACE Emax 2 circuit-breakers to be opened and closed remotely.

The Ekip com Actuator is optional and can be ordered for all Ekip trip units equipped with Ekip Com or Ekip Link modules; it is installed on the front of the circuit-breaker in the right-hand accessories area.

Electrical diagram reference: figure 76, 78



Ekip Bluetooth wireless communication unit

Ekip Bluetooth permits remote connection with the trip unit by portable PC, tablet or smart phone on which Ekip Connect software has been installed. The device is connected to the front test connector found on all Ekip trip units in SACE Emax 2 and SACE Tmax XT circuit-breakers and supplies power by means of a rechargeable Li-ion battery.



Signalling

Ekip 2K Signalling modules

The Ekip 2K Signalling modules supply two input and two output contacts for control and remote signalling of alarms and circuit-breaker trips. They can be programmed from the trip unit's display or through the Ekip Connect software. Furthermore, when using Ekip Connect, combinations of events can be freely configured. They are suitable for all distribution and generator protection versions of the Ekip Touch and Hi-Touch trip units.

Three versions of the Ekip 2K Signalling modules are available: Ekip 2K-1, Ekip 2K-2, Ekip 2K-3. In this way, a maximum of three modules for E2.2, E4.2, E6.2, and two for E1.2 can be installed at the same time.

Electrical diagram reference: figures 41, 42, 43



Ekip 4K signalling module

The Ekip 4K Signalling module, available for E2.2 – E4.2 – E6.2, supplies four input contacts and four output contacts for control and remote signalling. It can be programmed from the trip unit's display or through the Ekip Connect software. Furthermore, when using Ekip Connect, combinations of events can be freely configured.

It is installed in the housing provided in the front left of distribution and generator protection versions of the Ekip Touch and Hi-Touch trip units, without having to remove the trip unit itself and is an alternative to the AUX 6Q auxiliary contacts unit.

Electrical diagram reference: figure 2



Ekip 10K signalling unit

Ekip 10K Signalling is an external signalling unit designed for DIN rail installation for SACE Emax 2 automatic circuit-breakers. The unit provides ten contacts for electrical signalling of timing and tripping of protection devices.

If connected via the Ekip Connect software, the contacts can be freely configured in association with any event and alarm or combination of both.

Several Ekip 10K Signalling (max 4) can be installed at the same time on the same Ekip trip unit. The Ekip 10K Signalling module can be powered either by direct or alternating current and can be connected to all the trip units via internal bus or Ekip Link modules.

Electrical diagram reference: figure 103

Accessories

Accessories for Ekip trip units

Characteristics of output contacts		Number of contacts		
Type	Monostable	Ekip 2K	Ekip 4K	Ekip 10K
Maximum switching power (resistive load)	1250VA	2 output + 2 input	4 output + 4 input	10 output + 11 input
Maximum switching voltage	150V DC / 250V AC			
Maximum switching current				
30V DC	2A			
50V DC	0.8A			
150V DC	0.2A			
250V AC	4A			
Contact/coil insulation	2000 Vrms (1min @50Hz)			

Ekip 10K signalling unit power supply

Auxiliary supply	24-48V DC, 110-240V AC/DC
Voltage range	21.5-53V DC, 105-265V AC/DC
Rated power	8W

Signalling contacts for Ekip trip units (Ekip RTC and Ekip AUP)

Ekip trip units can acquire the status of circuit-breaker ready to close (RTC) and the racked-in, test, or racked-out position through the optional signalling contacts Ekip RTC and Ekip AUP. These contacts, housed in the accessories area of the circuit-breakers, are available with Ekip Dip, Ekip Touch and Ekip Hi-Touch.

Ekip COM communication modules and Ekip Link modules are always supplied with Ekip AUP and Ekip RTC contacts.



Measurement and protection

Ekip Measuring module

The Ekip Measuring module enables the trip unit to measure the phase and neutral voltages, powers and energy.

The Ekip Measuring module is installed on the front, right housing of the distribution protection versions of the Ekip Touch trip units, without having to remove the trip unit itself. The voltage connections are installed by default on the lower terminals, but can be altered to the upper terminals on request.

The measuring module requires no external connection since it is connected internally to the lower or upper terminals of Emax 2. If necessary, the voltage outlet connection can be moved outside the circuit-breaker by using voltmetric transformers and the alternative connection positioned in the terminal box. The use of external connections is obligatory for rated voltages that are higher than 690V. The module must be disconnected for dielectric strength tests on the main busbars.

Electrical diagram reference: figures 20, 21, 22, 23





1SDC200549F001

Ekip Measuring Pro module

The module has the same connection and installation characteristics as the Ekip Measuring module. In addition, the Ekip Measuring Pro version offers:

- Protection features voltage and power values
- Ekip trip unit power supply from busbar voltage (for line voltages greater than 85V)
- LED signalling when voltage is detected on the main busbars.

The Ekip Measurement Pro module comes standard with the Ekip Hi-Touch, Ekip G Touch and Ekip G-Hi Touch trip units.



1SDC200550F001

Ekip Synchrocheck

This module enables the control of the synchronism condition when placing two lines in parallel. The module can be used with distribution and generator protection versions of the Ekip Touch and Hi-Touch trip units equipped with the Ekip Measuring Pro module.

Ekip Synchrocheck measures the voltages from two phases of one line through an external transformer and, compares them to the measured voltages at the breaker utilizing the Ekip Measuring Pro Module. An output contact is available, which is activated upon reaching synchronism, and enables the circuit-breaker to be closed by means of wiring with the closing coil.

Characteristics of output contacts		Number of contacts
Type	Monostable	Ekip Synchrocheck
Maximum switching power (resistive load)	120W / 1250VA	1 output
Maximum switching voltage	150V DC / 250V AC	
Maximum switching current		
30V DC	2A	
50V DC	0.8A	
150V DC	0.2A	
250V AC	4A	
Contact/coil insulation	2000 Vrms (1min @50Hz)	

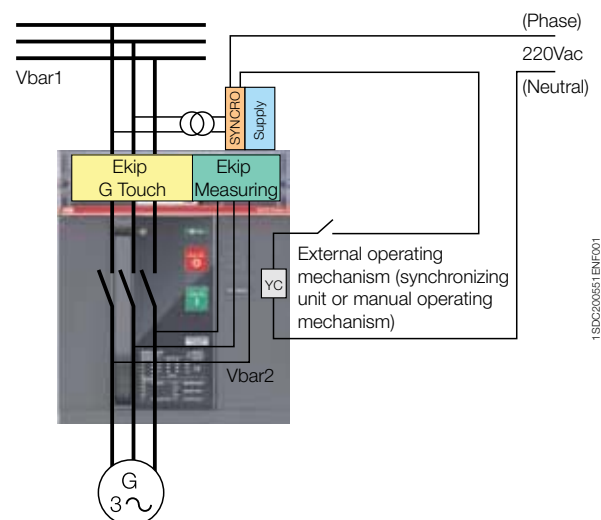

1SDC200551BNF001

Electrical diagram reference: figure 48

Accessories

Accessories for Ekip trip units



Ekip LCD display interface

For installations in particularly aggressive environments, as low temperatures, high humidity or presence of dust or chemical agents, the Ekip protection trip units can be requested with an LCD black and white display interface with pushbuttons for navigation. This version guarantees excellent immunity by integrating all functions, with regard to protection devices, measuring devices and the possibility of introducing accessories, available on the colour touch screen.

5



Rating Plug

The rating plugs are field interchangeable from the front on all trip units and enable the protection thresholds to be adjusted according to the actual rated current of the system. This function is particularly advantageous in installations that may require future expansion or in cases in which the power supplied needs to be limited temporarily (e.g. mobile Gen Set). The Overload (L) protection function can be disabled at any time by using an L OFF version of the rating plug. There is a matching L OFF version for each standard version of rating plug.

Circuit-breaker	Rating plugs available (both in standard and L OFF versions)
E1.2	400-630-800-1000-1250-1600
E1.2 250	100-200-250
E2.2	400-630-800-1000-1250-1600-2000-2500
E2.2 250	100-200-250
E4.2	400-630-800-1000-1250-1600-2000-2500-3200-4000
E6.2	400-630-800-1000-1250-1600-2000-2500-3200-4000-5000-6300

Special rating plugs are also available for differential protection against earthing faults in combination with a suitable toroid to be installed externally.

Circuit-breaker	Rating plug available for Rc protection
E1.2	400-630-800-1250
E1.2 250	100-200-250
E2.2	400-630-800-1250-2000
E2.2 250	100-200-250
E4.2	400-630-800-1250-2000-2500-3200-3600-4000



Current sensor for neutral conductor outside the circuit-breaker

This is only for three-pole circuit-breakers; it enables protection of the neutral conductor to be achieved through connection to the Ekip trip unit. It is supplied on request.

Electrical diagram reference: figure 27

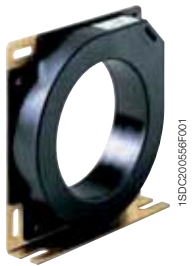

Homopolar toroid for the earthing conductor of main power supply

The distribution and generator protection versions of the Ekip Touch and Hi-Touch trip units can be used with an external toroid positioned, for example, on the conductor that connects the star centre of the MV/LV transformer to earth (homopolar transformer): in this case, the earth protection is called Source Ground Return. There are four sizes of the toroid: 100A, 250A, 400A, 800A. The homopolar toroid is an alternative to the toroid for differential protection.

Electrical diagram reference: figure 25



Toroid for differential protection

Connected to the Ekip Touch and Hi-Touch trip units equipped with a rating plug for differential protection, this toroid enables earth fault currents of 3...30A to be monitored.

To be installed on the busbar system, it is an alternative to the homopolar toroid.

Electrical diagram reference: figure 24

Accessories

Accessories for Ekip trip units



1SDC200558F001

Displaying and supervision

Ekip Multimeter Display on front of switchgear

Ekip Multimeter is a display unit to be installed on the front of the switchgear for SACE Emax 2 circuit-breakers equipped with Ekip electronic trip units. The device, 96mmx96mm sized, is equipped with a large touch screen display and enables measurements to be displayed with the same levels of precision. If connected to trip units with a display, Ekip Multimeter enables the adjustment of parameters and protection thresholds.

Up to 4 Ekip Multimeter devices can be connected at the same time to the same Ekip protection trip unit to display currents, voltage, powers and energy.

Ekip Multimeter can be powered either in direct current (24-48V DC or 110-240V DC) or in alternating current (110-240V AC). It is equipped with a 24V DC output that supplies the trip unit to which it is connected.

Power supply	24-48V DC, 110-240V AC/DC
Tolerance	21.5-53V DC, 105-265V AC/DC
Rated Power	8W

5



1SDC200558F001

Ekip Control Panel on front of switchgear

The Ekip Control Panel enables the SACE Emax 2 circuit-breakers connected to the Ekip Link system to be controlled and monitored.

The panel is supplied already equipped with supervision software and requires no programming. Ekip Control Panel requires a 24V DC power supply and is equipped with:

- 2 RJ45 EtherNet ports for connection to the Ekip Link system and to the local network for remote control via web server option
- 1 RS485 serial port for integration of the Modbus network if it is to be used with circuit-breakers of the Tmax series
- 4 USB ports for downloading data.



1SDC200688F001

Testing and programming

Ekip TT testing and power supply unit

Ekip TT is a device that allows you to verify that the circuit-breaker trip mechanism is functioning correctly (trip test).

It also allows a trip unit not provided with auxiliary power supply to be supplied with power so that the last protection device tripped can be displayed directly on the screen or by the lighting up of corresponding LEDs.

The device can be connected to the front test connector of any Ekip trip unit of SACE Emax 2; it is supplied as standard with the versions for distribution and generator protection of the Ekip Touch, Hi-Touch trip units to set protection functions setting.



1SDC200561F001

Ekip T&P testing kit

Ekip T&P is a kit that includes different components for programming and testing the electronic protection trip units.

The kit includes:

- Ekip T&P unit;
- Ekip TT unit;
- adaptors for Emax and Tmax trip units;
- USB cable to connect the T&P unit to the Ekip trip units;
- installation CD for Ekip Connect and Ekip T&P interface software.

The Ekip T&P unit is easily connects from your PC (via USB) to the trip unit (via mini USB) with the cable provided.

The Ekip T&P unit can perform simple manual or automatic tests on the trip unit functions.

The Ekip T&P will also provide the ability to conduct more advanced function testing that allows the addition of harmonics and the shifting of phases to more accurately represent the real conditions of an application. Thus, leading to more concise protection function parameters that may be required for critical applications. It can also generate a test report as well as help you to monitor maintenance schedules.



1SDC200561F001

Ekip Programming Module

The Ekip Programming module is used for programming Ekip trip units via USB to a PC using the Ekip Connect software that can be downloaded on-line. This can be useful for uploading/downloading entire sets of parameters for multiple breakers both for set-up as well as for maintenance (for periodic cataloging breaker parameters in case of a catastrophic situation).

Accessories

Spare parts

5

Spare parts

The following original and guaranteed spare parts are available:

- Front shield and lateral covers
- Opening solenoid for Ekip protection trip unit
- Arc chamber
- Complete pole
- Operating mechanism and closing springs
- Loading lever for closing springs
- Racking-out lever
- Racking-out handle and plates
- Jaw isolating contact for fixed part of withdrawable circuit-breaker
- Shutters for fixed part
- Trip units - current transformers wires
- Transparent protection for trip unit
- Mainboard for protection trip units
- Terminal box and e sliding contacts
- Grease and oil.

For further details, please refer to ABB SACE Spare Parts Catalogue.

Installation

Circuit-breaker	6/2
Sizes	6/3
Versions	6/4
Poles	6/5
Terminals	6/6
Degree of protection	6/7
Power losses	6/7
Temperature derating	6/8
Current-limiting curves	6/9

Installation environment	
Temperature	6/10
Environmental conditions	6/10
Vibration	6/10
Electromagnetic compatibility	6/10

Installation in switchgear	6/11
Position	6/12
Power supply	6/12
Insulation distances and connection	6/12
Busbar types	6/14
Accessories	6/14

Performance in switchgear	6/15
----------------------------------	-------------

Installation

Circuit-breaker

The new SACE Emax 2 family maintains the characteristics of strength and reliability that have always distinguished the tradition of ABB SACE air circuit-breakers.

The new SACE Emax 2 circuit-breakers, available in four sizes, are extremely compact due to their new dimensions: with reduced depths and heights, combined with rationalized widths, they provide the answer to the most stringent installation requirements.

Safety is guaranteed thanks to the double insulation of the live parts and total segregation of the phases. Furthermore, the new functional design of the SACE Emax2 circuit-breakers has been developed with the purpose of improving installation operations and use of the devices and accessories; making them simple, intuitive and safe.

Distinctive characteristics		Benefits
6 Simplicity of use and safety	- Ekip protection trip units are interchangeable from front of circuit-breaker	Reduced times during the stages of: - installation - wiring - configuration - commissioning - maintenance
	- Rapid configuration of the Ekip trip units	
	- Electronic modules can be installed on terminal box without removing the electronic trip units and protection shield	
	- Electrical plug-in accessories can be installed from the front of circuit-breaker	
	- New push-in terminal box allows rapid auxiliary connections	Increased level of safety
	- Horizontal or vertical rear connections can be modified on-site by turning 90°	
	- Accessorizing logic common to the entire family of circuit-breakers	
	- Accessory cabinet and terminal box are stamped with accessory codes for easy identification	
	- Accessories area is separated functionally from the safety area	
	- Mechanical safety locks in open position are active when the shield is removed	
- Guided racking in and out of the mobile part		

Sizes

The SACE Emax2 circuit-breakers, available in 4 sizes up to 6300A, provide:

- **Versatility**, where installation space is a critical and influential factor, such as naval applications, wind turbine towers or switchgear
- **Opportunities**, optimization of the dimensions of the electrical switchgear results in a potential reduction in the consumption of the materials used.

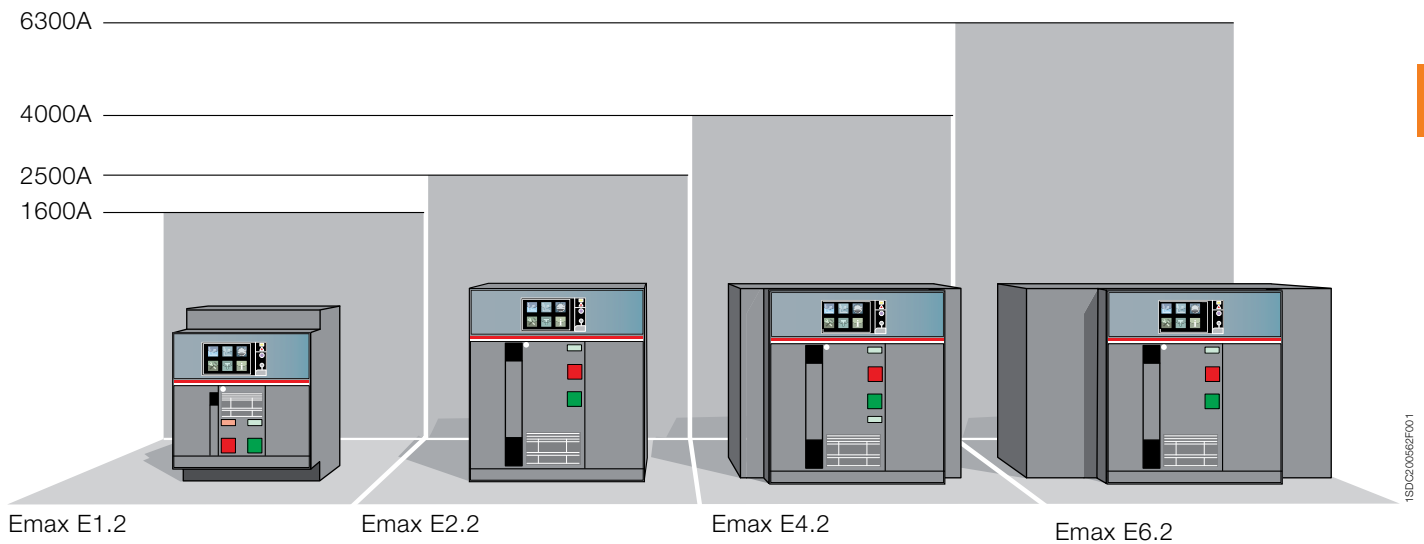

Installation

Circuit-breaker

Versions

The SACE Emax2 circuit-breakers are available in both fixed and withdrawable versions. The withdrawable version is recommended in applications in which service continuity is a fundamental requirement. Replacement of the moving part with a new device does not require any intervention on power connections or on auxiliary connections, thus permitting reset in the shortest time possible.

The fixed version, which is connected directly to power system through the circuit-breaker terminals, is recommended in applications in which the need for space means that compact products are required without compromising the performance and possibility of fitting accessories.

6

Fixed



1SDC200664F001

Withdrawable



1SDC200664F001

1. Moving part
2. Sliding contacts
3. Fixed part
4. Terminal box
5. Racking-out mechanism
6. Racking-out guide rails
7. Pushbuttons
8. Data label and accessories

Poles

SACE Emax 2 circuit-breakers are available in three-pole and four-pole versions and can be used in all types of distribution systems. Furthermore, with the possibility of connecting the external current sensor, three-pole circuit-breakers can be used efficiently even in systems in which the neutral conductor cannot be isolated.

The four-pole circuit-breakers E1.2, E2.2 and E4.2 are always provided with full-size neutral pole with rated uninterrupted current-carrying capacity identical to the phase poles. The E6.2 circuit-breakers, thanks to their construction modularity, are available with neutral set at 50% - normal supply – and with full-size neutral, so that the customer does not need to oversize the neutral unless strictly necessary.

The standard supplied circuit breakers are suitable for connection of phases in the sequence L1, L2, L3 for three-pole circuit-breakers, or N, L1, L2 and L3 for four-pole circuit-breakers with neutral on the left; a special optional kit enables the position of the circuit-breaker neutral to be changed to the right, making the sequence L1, L2, L3, N available (refer to page 9/53 for the commercial codes).

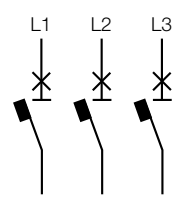
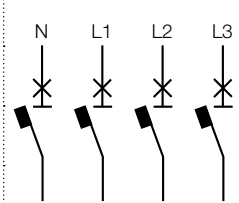
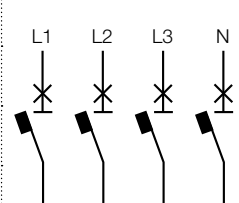
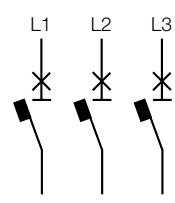
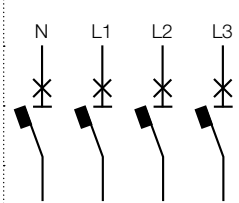
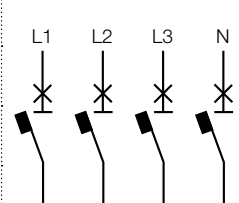
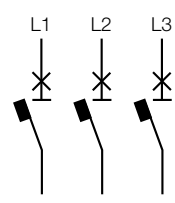
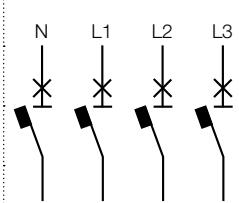
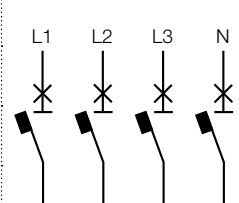
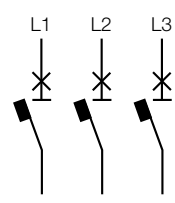
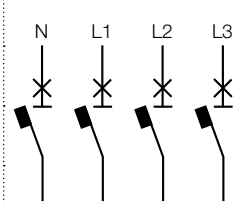
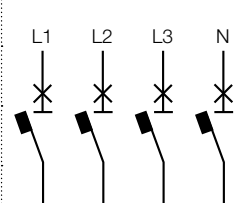
Circuit-breaker	Standard version		Optional version with neutral on the right
	Three-pole	Four-pole	Four-pole
Emax E1.2			
Emax E2.2			
Emax E4.2			
Emax E6.2			

Installation

Circuit-breaker

Terminals

The integration of the circuit-breaker in the electrical system is simplified because of the connection terminals of the circuit-breakers. The silver-plated copper terminals are designed to assist installation of connecting bars according to the change in the rated capacity of the circuit-breaker. Each terminal has been created to the standard width of busbar for that amperage and is equipped with one, two or three terminal stabs for easy connection to multiple bus runs that may be required for the application. For particular installation requirements, the circuit-breakers can be equipped with different combinations of terminals for the upper and lower part.

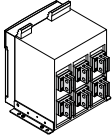
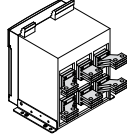
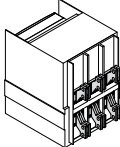
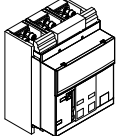
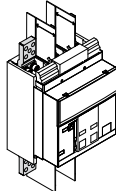
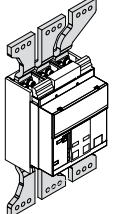
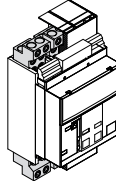
Type	Abbreviation		E1.2	E2.2	E4.2	E6.2
Rear adjustable terminal ⁽¹⁾	HR VR		F, W	F, W	F, W	F, W
6 Horizontal rear spread terminal	SHR		W	F, W		
Vertical rear spread terminal	SVR			F, W		
Front terminal	F		F	F, W	F, W	F, W
Extended front terminal	EF		F, W			
Front spread terminal	ES		F, W			
Terminal for cable FcCuAl 4x240mm ²	Fc CuAl		F, W			
Flat terminal	FL			W	W	W

(1) The rear adjustable terminals are supplied as standard in the HR-HR configuration.

Degree of protection

The SACE Emax2 circuit-breakers guarantee the following degrees of protection:

- IP20 for circuit-breakers in fixed or withdrawable versions, excluding the terminals.
- IP30 for the front parts of the circuit-breaker when installed in switchgear with IP30 flange mounted on the door.
- IP54 for circuit-breakers equipped with optional IP54 transparent flange fixed on the door in front of the switchgear.

Power losses

To guarantee the performance of the electrical switchgear in terms of rated uninterrupted current-carrying capacity, the design of the electrical switchgear must take into consideration the power losses by the apparatus and by live parts installed.

These power losses are measured according to IEC60947 product standard, the values given in the table refer to total power for three and four pole circuit-breakers with balanced loads with a current flow equal to rated uninterrupted current "I_u" at 50/60Hz.

Circuit-breaker type		I _u	630A	800A	1000A	1250A	1600A	2000A	2500A	3200A	4000A	5000A	6300A
Fixed	E1.2 B/C/N	[W]	31	50	78	122	201	-	-	-	-	-	-
	E2.2 B/N/S/H	[W]	-	34	53	83	136	212	267	-	-	-	-
	E4.2 N/S/H/V	[W]	-	-	-	-	-	-	-	425	465	-	-
	E6.2 H/V/X	[W]	-	-	-	-	-	-	-	-	309	483	767
Withdrawable	E1.2 B/C/N	[W]	62	100	156	244	400	-	-	-	-	-	-
	E2.2 B/N/S/H	[W]	-	72	113	176	288	450	550	-	-	-	-
	E4.2 N/S/H/V	[W]	-	-	-	-	-	-	-	743	900	-	-
	E6.2 H/V/X	[W]	-	-	-	-	-	-	-	-	544	850	1550

Installation

Circuit-breaker

Temperature derating

Under certain installation conditions, the circuit-breakers can operate at higher temperatures than the reference temperature of 40 °C. In this case the current-carrying capacity of the circuit-breaker may be lower than the rated current-carrying capacity at the reference temperature: therefore the derating coefficients shown in the table must be applied. Percentage values refer to withdrawable and fixed circuit breaker. If not specified, all data refer to a copper cross section according to IEC60947.

Emax 2 E1.2		Cross section	Temperature [°C]						
			<40	45	50	55	60	65	70
E1.2	250		100%	100%	100%	100%	100%	100%	100%
E1.2	630		100%	100%	100%	100%	100%	100%	100%
E1.2	800		100%	100%	100%	100%	100%	100%	100%
E1.2	1000		100%	100%	100%	100%	100%	100%	100%
E1.2	1250		100%	100%	100%	100%	100%	100%	100%
E1.2	1600		100%	100%	100%	98%	95%	93%	90%
E1.2	1600	1200 mm ²	100%	100%	100%	100%	97%	95%	92%

Emax 2 E2.2		Cross section	Temperature [°C]						
			<40	45	50	55	60	65	70
E2.2	250		100%	100%	100%	100%	100%	100%	100%
E2.2	800		100%	100%	100%	100%	100%	100%	100%
E2.2	1000		100%	100%	100%	100%	100%	100%	100%
E2.2	1250		100%	100%	100%	100%	100%	100%	100%
E2.2	1600		100%	100%	100%	100%	100%	100%	98%
E2.2	2000		100%	100%	100%	100%	95%	91%	87%
E2.2	2500		100%	100%	100%	100%	98%	94%	90%

Emax 2 E4.2		Cross section	Temperature [°C]						
			<40	45	50	55	60	65	70
E4.2	2000		100%	100%	100%	100%	100%	100%	100%
E4.2	2500		100%	100%	100%	100%	100%	100%	100%
E4.2	3200	3000 mm ²	100%	100%	97%	93%	89%	86%	82%
E4.2 (*)	3200	3000 mm ²	100%	100%	100%	100%	95%	93%	89%
E4.2	4000	4000 mm ²	100%	100%	94%	90%	86%	83%	80%

(*) Three stabs terminal kit

Emax 2 E6.2		Cross section	Temperature [°C]						
			<40	45	50	55	60	65	70
E6.2	4000	4000 mm ²	100%	100%	100%	100%	100%	100%	100%
E6.2	5000	5000 mm ²	100%	100%	100%	100%	100%	98%	95%
E6.2	6300	6000 mm ²	100%	100%	95%	91%	87%	84%	81%

Current-limiting curves

The SACE Emax2 series features a series of current-limiting circuit-breakers in sizes E1.2 up to 1600A. These circuit-breakers are distinguished constructively by:

- Dedicated stored energy operating mechanism, which reduces opening times.
- Specific main contacts which, utilizing the electrodynamic forces generated by the short-circuit current, accelerate opening of the main contacts.

These features ensure rapid interruption which consequently reduces electromechanical and thermal stress on the system during a short-circuit. The current-limiting circuit-breakers are distinguished by short-time withstand currents I_{sw} that are not particularly high and therefore not indicated for applications in which chronoamperometric selectivity is required with several downstream devices or in which devices are present with high inrush current in the start-up stage.

Current-limiting curves

E1.2 L

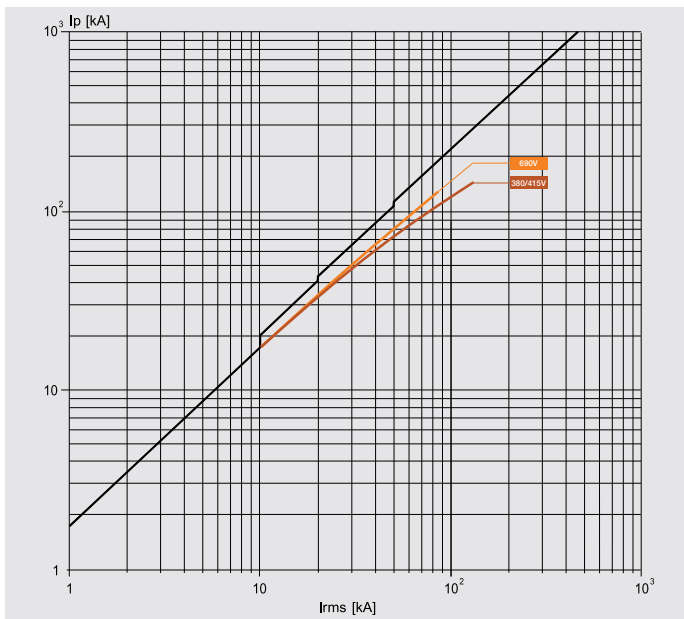

Current-limiting curves of specific let-through energy

E1.2 L

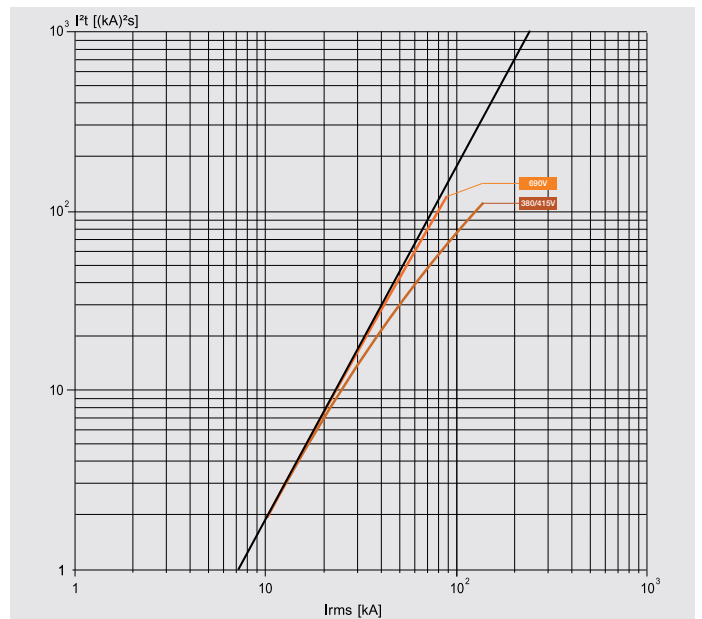

Installation

Installation environment

SACE Emax 2 circuit-breakers have been designed and tested in accordance with major international Standards to manage with maximum reliability the electrical plant. The installation requirements prescribed by the international Standards are listed below. In addition, ABB provides instructions for the use of circuit-breakers in nonstandard environments, as for example personalized maintenance program or installation solutions aimed at increasing performances and extending the lifecycle of the circuit-breaker.

Temperature

SACE Emax2 circuit-breakers can operate in the following environmental conditions:

	Temperature (°C)		
	Operating	Active Display	Storage
Emax 2 with Ekip DIP	-25°C ... +70°C	-	-40°C ... +70°C
Emax 2 with Ekip Touch	-25°C ... +70°C	-20°C ... +70°C	-30°C ... +70°C
Emax 2 with LCD	-25°C ... +70°C	-25°C ... +70°C	-40°C ... +70°C
Emax 2 switch-disconnectors	-25°C ... +70°C	-	-40°C ... +70°C

Environmental conditions

The devices can be installed in industrial environments with pollution level 3, IEC60947. SACE Emax 2 circuit-breakers also comply with:

- IEC60721-3-6 class 6C3
- IEC60721-3-2 class 3C2

Altitude

SACE Emax 2 air circuit-breakers do not undergo changes in rated performance up to 2000 metres. Beyond this altitude, the properties of the atmosphere in terms of composition, dielectric capacitance, cooling power and pressure can vary and, therefore, the performance of the circuit-breakers is subject to derating, which can be measured by means of the variation in maximum rated service voltage and rated uninterrupted current.

Altitude		[m]	2000	3000	4000	5000
Rated service voltage - Ue	Versions 690V	[V]	690	607	538	470
	Versions 1150V	[V]	1150	1012	897	782
Rated current		[% In]	100	98	93	90

An installation at 3000 m of a 690V AC rated service voltage can be an explicative example. The altitude, as shown in the table, may cause a derating which precludes the use of a standard automatic circuit-breaker. To grant the use of a circuit-breaker at 690V AC rated service voltage is therefore required a 1150V AC version that – despite the derating – fulfill the necessary rated service voltage. In addition, the selection of the circuit-breakers has to be based on the short -circuit performance required by the application.

Vibration

The circuit-breakers have been tested according to:

- IEC60068-2-6
 - From 1 to 13 Hz with amplitude 1mm
 - From 13 to 100 Hz with constant acceleration 0.7g
- IEC60721-3-1
 - Storage: 1M3
- IEC60721-3-2
 - Transport: 2M2
- IEC60721-3-3
 - Operational conditions: 3M2
- Shipping registers or certifications

Electromagnetic compatibility

The use of specific devices in industrial installations may cause electromagnetic interference in the electrical system. SACE Emax 2 circuit-breakers have been developed and tested for electromagnetic compatibility in accordance with IEC 60947-2, Appendices J and F.

Installation

Installation in switchgear

Due to the four construction sizes and the reduced insulation distances required, SACE Emax2 circuit-breakers optimize the installation spaces of the compartments of electrical switchgear, thereby providing a rational solution to the customers' application needs.

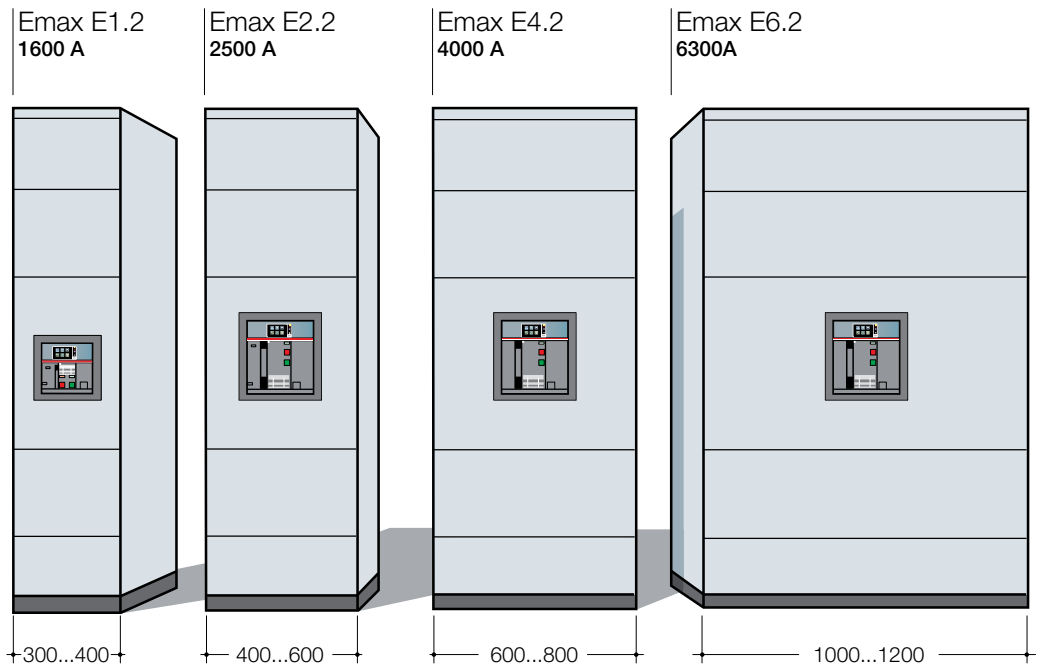

SACE Emax2 circuit-breakers enable the design of electrical switchgear to be improved, optimization in terms of performance and also in the use of the main materials:

- **Copper:** thanks to the possibility of developing compact units, the length of the distribution system / busbar can be minimized.
- **Metal frame and structure:** reduced volumes also mean less surface space is used for panels and internal structures.
- **Space:** the optimization of the individual units benefits the entire switchgear, which is more compact and can therefore be installed taking up less surface space.

Traditional circuit-breaker 3p lu 2500A

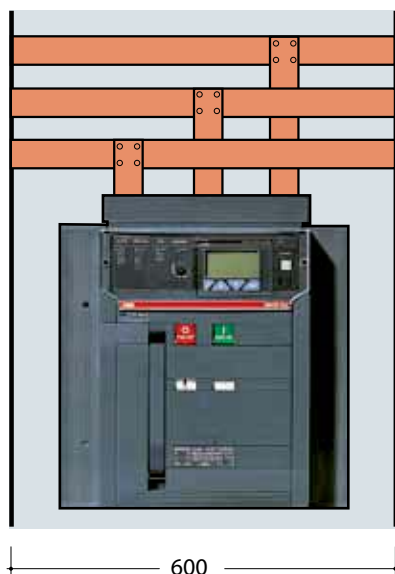

Emax E2.2 3p lu 2500A

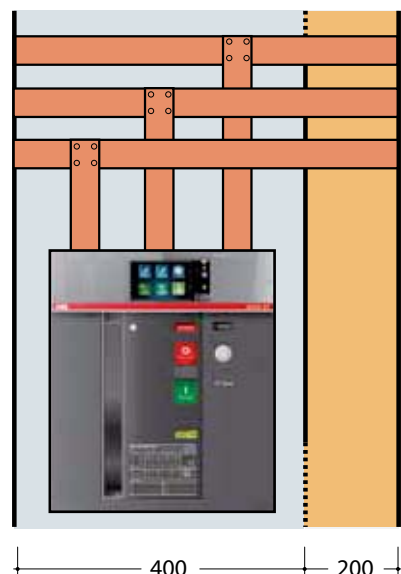

Efficiencies with Emax 2:

- ▶ Possibility of saving in copper
- ▶ Possibility of saving in metal frame, segregation and plates
- ▶ Possibility of saving in the installation surface

1SDC200569F001

Installation

Installation in switchgear

6

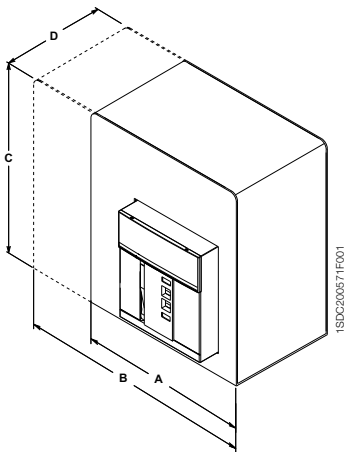
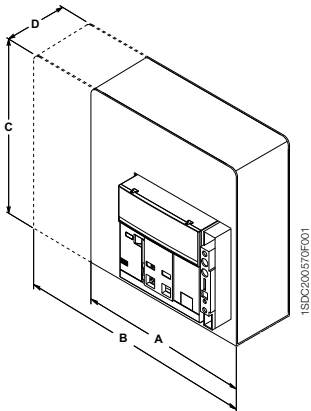

Position

All SACE Emax 2 circuit-breakers can be floor mounted in a vertical position inside the switchgear compartment.

The E1.2 circuit-breaker can also be installed in a horizontal position and wall mounted. Conveniently, the screens of the Ekip Touch and Hi-Touch versions rotate to a horizontal view for key data when the E1.2 is installed horizontally.

Power supply

The Emax 2 circuit-breakers can be supplied, indifferently, from either the upper or lower terminals. In the event a measurement module is present, in order to make use of all information when the circuit-breaker is in the open position, the voltage sockets must be installed on the power supply side.

Insulation distances and connection

The circuit-breakers can be connected to the main power system using the most common configurations and dimensions of copper bars. Installation of live parts must ensure:

– Minimum insulation distances between the phases

Rated insulation voltage Ui	Minimum distance [mm]
1000V	for voltages upper to 440V in fixed circuit-breakers, please use phase separators

– Insulation distance of installation cubicle

Fixed circuit-breakers

[mm]	A	B	C	D
	3p	4P		
E1.2	250	322	382.5*	130
E2.2	400	490	500	221
E4.2	500	600	500	221
E6.2	900	1000	500	221
E6.2/f	-	1200	500	221

* 332.5mm for voltage less \leq 440V AC

Withdrawable circuit-breakers

[mm]	A	B	C	D
	3p	4P		
E1.2	280	350	440*	252
E2.2	400	490	500	355
E4.2	500	600	500	355
E6.2	900	1000	500	355
E6.2/f	-	1200	500	355

* 390mm for voltage less \leq 440V AC

– Anchorage plates

The electrodynamic force released during a short-circuit can cause high levels of mechanical stress to the devices and structures of the switchgear. To minimize this, fastening plates must be positioned near the circuit-breaker terminals.

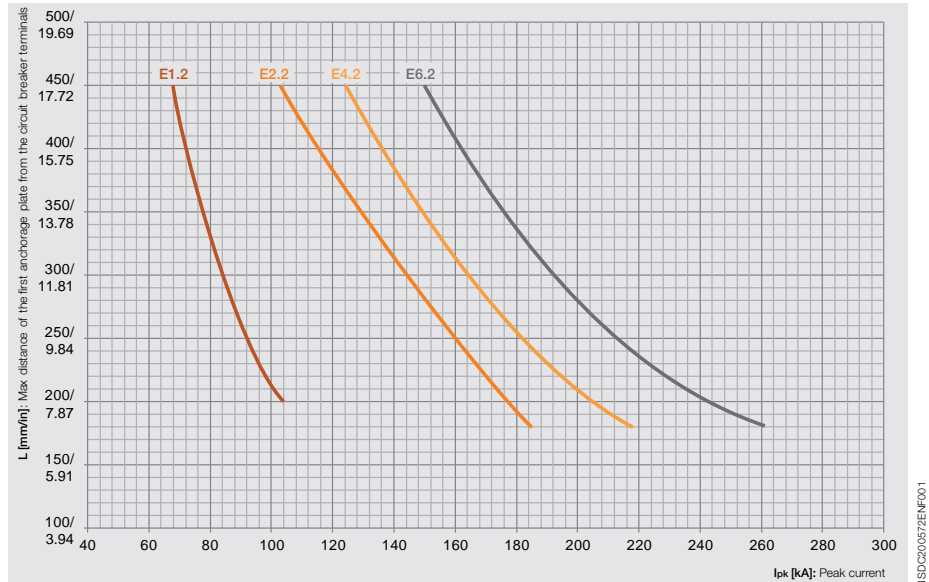

– Tightening torques

The following table indicates the values required for connecting the circuit-breaker terminal and the connecting bars.

Terminals	E1.2	E2.2 / E4.2 / E6.2
Modifiable HR/VR rear	40 Nm	70 Nm
Spread rear	40 Nm	70 Nm
Front	40 Nm	70 Nm
Extended front	40 Nm	70 Nm
Spread front	70 Nm	70 Nm
Front for cables	43 Nm	70 Nm

– Segregation plates and separator plates

The rear part of the circuit-breaker has been designed with specific slots in which insulating walls can be housed to facilitate segregation of live parts. In addition, phase separators are available as optional accessories.

Earthing connection

To achieve continuity and equal potential of earthing between the Emax 2 circuit-breaker and the protection circuit of the switchboard, customers can do either of the options below:

- Connect the Emax 2 fixed circuit-breaker or the fixed part of the withdrawable circuit-breaker to the protective circuit by means of a cable with suitable cross-sectional area to fulfil the requirements of clause 10.5.2 to the Standard IEC 61439-1.
- If the continuity of the circuit-breaker frame with the switchboard earthing is guaranteed by the metal contact (support) between the circuit-breaker and the metal structure of the switchboard (which is a part of the protective circuit) no connection is necessary (provided that no panels of insulating material are interposed between the circuit-breaker and the metal frame of the switchboard). Emax E1.2, fixed version, does not require any earthing connection.

Installation

Installation in switchgear

Busbar types

The circuit-breakers, via the terminals, can be connected to the main distribution system by busbars of different types: copper, silver-plated copper and tinned aluminium when the main distribution system is made of aluminium.

The circuit-breakers can be connected directly with copper or aluminium cables in the case of E1.2 circuit-breakers, or indirectly by cable-carrying bars in the case of E2.2, E4.2 e E6.2.

Accessories

The SACE Emax 2 circuit-breakers offer a wide range of accessories that improve safety levels for technicians working on the switchgear and circuit-breakers. Furthermore, thanks to the different types of mechanical interlock available, pre-determined coordination strategies can be achieved between the circuit-breakers. In detail:

- Horizontal and vertical interlocks between circuit-breakers
- Door lock with circuit-breaker in closed position
- Switchgear door lock in racked-in/out position
- Lock of racked-out mechanism with door open
- External lock of shutters
- Flange for switchgear door IP30 and IP54

For further information of the operation of accessories, see chapter 5.



Installation

Performance in switchgear

The many types of switchgear that can be created and the installation and environmental conditions can considerably influence the performance of the circuit-breaker. In this regard, SACE Emax 2 circuit-breakers offer the best solution for improving the capacity in switchgear.

The following application situations have been assessed by taking into consideration the main factors that can influence the performance of the circuit-breaker in switchgear:

- Type of switchgear
- Switchgear degree of protection
- Segregation form 3
- Size of circuit-breaker
- Number of devices connected at the same time in the unit
- Type of terminal and connection
- Ambient temperature T_a (IEC61439-1)
- Withdrawable circuit-breakers
- Maximum withstand temperature for the terminal 120° C

Installation

Performance in switchgear

The following tables provide an indication of the performance of the apparatus inside the switchgear. The data shown are a summary of software model simulations and real tests.

SACE Emax 2 E1.2 B C N Circuit-breaker

Switchgear dimensions 2200x400x600 (HxWxD)

HR Terminal

One circuit-breaker in the column

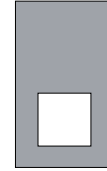

Environment temperature

IP	Iu	Connection [mm]	Compartment	Environment temperature		
				35 °C	45 °C	55 °C
IP31	630	2x40x5	2	630	630	630
			1			
	800	2x50x5	2	800	800	800
			1			
	1000	2x50x10	2	1000	1000	1000
			1			
	1250	2x50x8	2	1250	1250	1200
			1			
	1600	3x50x8	2	1440	1360	1290
			1			
		2x50x10	2			
			1			

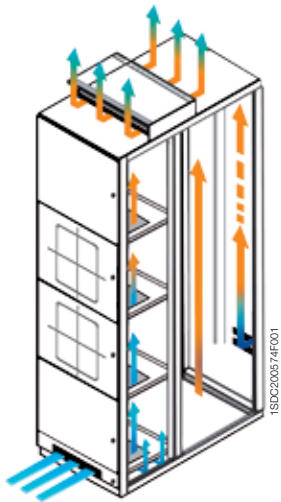

Performances with EF, SHR and F terminals can be compared, with the same connection sections, to the performances of circuit-breaker with HR terminal.
 Performances with ES terminals can be compared to the VR terminals.
 Performances with FC CuAl terminals, with cables in the prescribed sections, can be compared to HR performances.

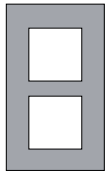
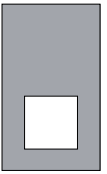
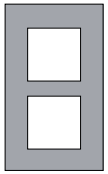
HR Terminal Two circuit-breakers in the column			VR Terminal One circuit-breaker in the column			VR Terminal Two circuit-breakers in the column		
								
Environment temperature			Environment temperature			Environment temperature		
35 °C	45 °C	55 °C	35 °C	45 °C	55 °C	35 °C	45 °C	55 °C
630	630	630				630	630	630
630	630	630	630	630	630	630	630	630
800	800	800				800	800	800
800	800	800	800	800	800	800	800	800
970	930	900						
1000	960	920						
						1000	1000	950
			1000	1000	1000	1000	1000	970
1200	1150	1100						
1250	1200	1140						
						1250	1250	1150
			1250	1250	1250	1250	1250	1200
1330	1260	1220						
1370	1315	1262						
						1430	1355	1265
			1520	1440	1330	1475	1415	1310

Installation

Performance in switchgear

The following tables provide an indication of the performance of the apparatus inside the switchgear. The data shown are a summary of software model simulations and real tests.

SACE Emax 2 E2.2 B N S H Circuit-breaker Switchgear dimensions 2200x600xx900 (HxWxD)

HR Terminal One circuit-breaker in the column

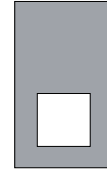

Environment temperature

IP	Iu	Connection [mm]	Compartment	Environment temperature		
				35 °C	45 °C	55 °C
IP31	800	1x50x10	2			
			1	800	800	800
	1000	2x50x5	2			
			1	1000	1000	1000
	1250	2x50x10	2			
			1	1250	1250	1250
	1600	2x60x10	2			
			1	1600	1540	1480
		1x100x10	2			
			1			
	2000	3x60x10	2			
			1	2000	1940	1850
		2x80x10	2			
			1			
		3x60x10 *	2			
			1	2000	2000	1940
2x80x10 *	2					
	1					
2500	3x60x10	2				
		1	2500	2350	2200	
	4x100x5	2				
		1				
	3x60x10 *	2				
		1	2500	2460	2320	
4x100x5 *	2					
	1					

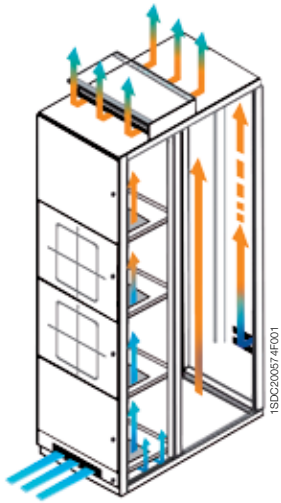

6

Compartment 2

Compartment 1

* Performances refer to SHR and SVR terminals.

Performances with F and FL terminals can be compared to the performance of circuit-breakers with HR terminals.

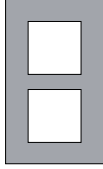
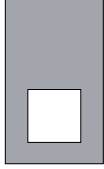
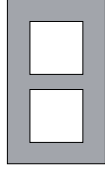
HR Terminal Two circuit-breakers in the column			VR Terminal One circuit-breaker in the column			VR Terminal Two circuit-breakers in the column		
								
Environment temperature			Environment temperature			Environment temperature		
35 °C	45 °C	55 °C	35 °C	45 °C	55 °C	35 °C	45 °C	55 °C
800	800	800				800	800	800
800	800	800	800	800	800	800	800	800
1000	1000	1000				1000	1000	1000
1000	1000	1000	1000	1000	1000	1000	1000	1000
1250	1250	1250				1250	1250	1250
1250	1250	1250	1250	1250	1250	1250	1250	1250
1470	1410	1360						
1550	1490	1430						
						1500	1470	1400
			1600	1600	1520	1580	1550	1475
1920	1810	1720						
1950	1850	1760						
						1950	1860	1760
			2000	2000	1920	2000	1920	1810
2000	1900	1810						
2000	1945	1850						
						2000	1950	1850
			2000	2000	2000	2000	2000	1900
2280	2200	2100						
2400	2310	2170						
						2400	2270	2160
			2500	2450	2350	2500	2380	2270
2394	2310	2205						
2500	2430	2280						
						2500	2390	2270
			2500	2500	2460	2500	2500	2380

Installation

Performance in switchgear

The following tables provide an indication of the performance of the apparatus inside the switchgear. The data shown are a summary of software model simulations and real tests.

SACE Emax 2 E4.2 N S H V Circuit-breaker Switchgear dimensions 2200x800xx900 (HxWxD)

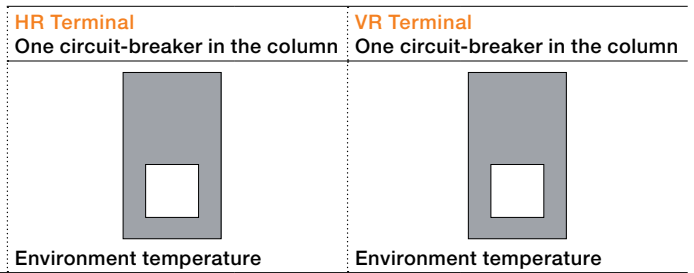

IP	Iu	Connection [mm]	Compartment	Environment temperature			Environment temperature		
				35 °C	45 °C	55 °C	35 °C	45 °C	55 °C
IP31	2000	2x80x10	1	2000	2000	2000	2000	2000	2000
6 Compartment 2	2500	2x100x10	1	2500	2450	2400	2500	2500	2500
	3200	3x100x10	1	3050	2900	2755	3200	3080	2920
Compartment 1	3200	3x100x10*	1	3200	3050	2850	3200	3200	3020
	4000	4x100x10	1	3450	3200	2970	3650	3400	3200

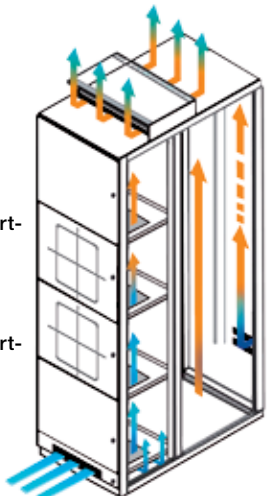

* Performances refer to withdrawable circuit-breakers with a fixed part accessorized with three stab rear terminals for 4000A (Example: 1SDA074021R1 - KIT VR 4000A)
Performances with F and FL terminals can be compared to the performances of circuit-breaker with HR terminal.

The following tables provide an indication of the performance of the apparatus inside the switchgear. The data shown are a summary of software model simulations and real tests.

SACE Emax 2 E6.2 H V X Circuit-breaker
Switchgear dimensions 2200x1200x900 (HxLxD)

HR Terminal
One circuit-breaker in the column

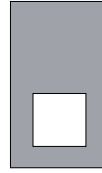

Environment temperature

VR Terminal
One circuit-breaker in the column

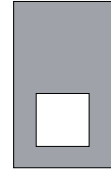

Environment temperature

IP	lu	Connection [mm]	Compartment	Environment temperature			Environment temperature		
				35 °C	45 °C	55 °C	35 °C	45 °C	55 °C
IP31	4000	4x100x10	1	4000	4000	4000	4000	4000	4000
Compartment 2	5000	5x100x10	1	5000	5000	4900	5000	5000	5000
Compartment 1	6300	6x100x10	1	5650	5350	4850	6000	5700	5250

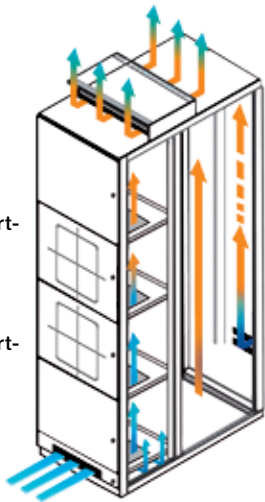

Performances with F and FL terminals can be compared to the performances of circuit-breaker with HR terminal.

Installation

Performance in switchgear

The following tables provide an indication of the performance of the apparatus inside the switchgear. The data shown are a summary of software model simulations and real tests.

SACE Emax 2 E1.2 L Circuit-breaker

Switchgear dimensions 2200x400x600 (HxWxD)

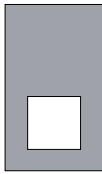
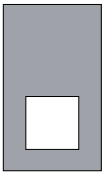
HR Terminal One circuit-breaker in the column	VR Terminal One circuit-breaker in the column
	
Environment temperature	

IP	lu	Connection [mm]	Compartment	Environment temperature			Environment temperature		
				35 °C	45 °C	55 °C	35 °C	45 °C	55 °C
IP31	630	2x40x5	1	630	630	630	630	630	630
	800	2x50x5	1	800	800	800	800	800	800
	1000	2x50x10	1	1000	1000	950			
		2x50x8					1000	1000	1000
	1250	2x50x10	1	1250	1125	955			
		2x50x8	1				1250	1205	1050

6

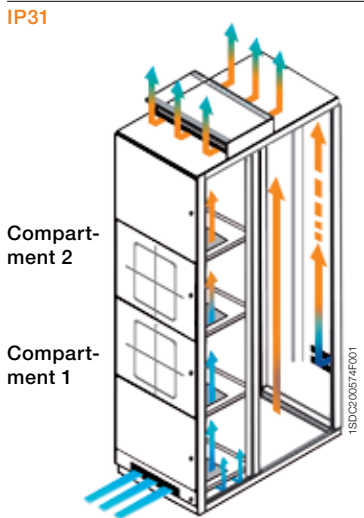

Performances with EF, SHR and F terminals can be compared, with the same connection sections, to the performances of circuit-breaker with HR terminal.
 Performances with ES terminals can be compared to the VR terminals.
 Performances with FC CuAl terminals, with cables in the prescribed sections, can be compared to HR performances.

Dimensions

Fixed circuit-breaker	7/2
E1.2	7/4
E2.2	7/8
E4.2	7/12
E6.2	7/14

Withdrawable circuit-breaker	7/18
E1.2	7/20
E2.2	7/24
E4.2	7/28
E6.2	7/30

Dimensions

Fixed circuit-breaker

E1.2

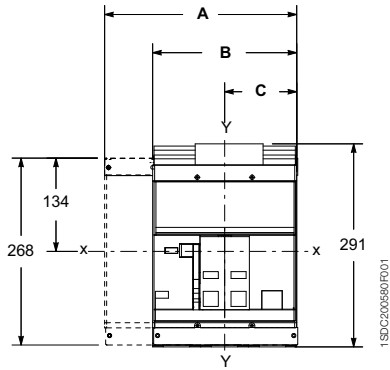

E2.2 - E4.2 - E6.2

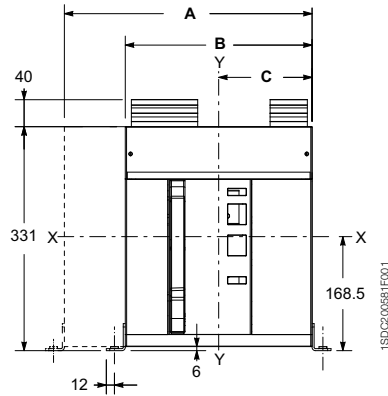

	A	B	C	
[mm]	4p	3p	3p	4p
E1.2	284	214	107	107
E2.2	366	276	138	138
E4.2	510	384	192	192
E6.2	888	762	318	444
E6.2/f	1014	-	-	444

7

Compartment door drilling

E1.2

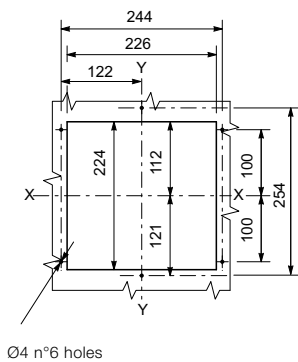

Ø4 n°6 holes

E2.2 - E4.2 - E6.2

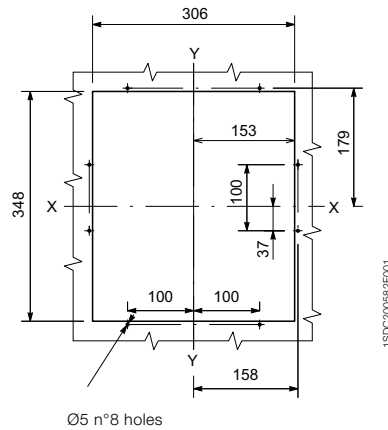

Ø5 n°8 holes

E1.2

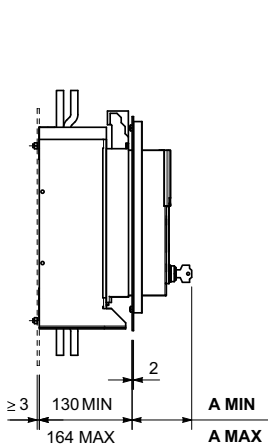

E2.2 - E4.2 - E6.2

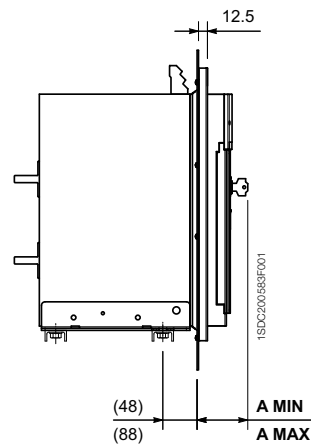

E1.2	Standard	Ronis/Profalux	Kirk	Castell
A MIN [mm]	49.5	63.5	63.5	83.5
A MAX [mm]	83.5	97.5	97.5	117.5

E2.2-E4.2-E6.2	Standard	Ronis/Profalux	Kirk	Castell
A MIN [mm]	31	41.5	45.5	-
A MAX [mm]	71	81.5	85.5	-

Dimensions of the compartment

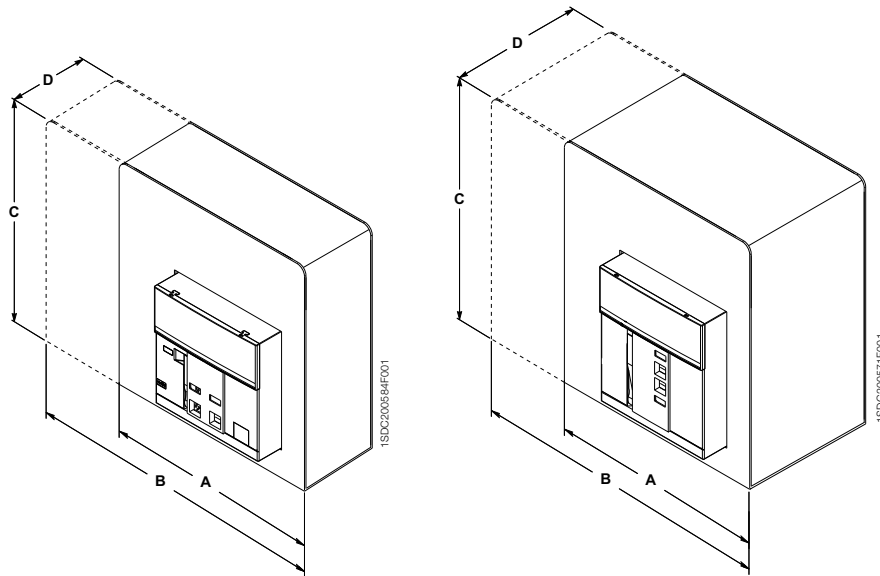

[mm]	A	B	C	D
E1.2	250	322	382.5 *	130
E2.2	400	490	500	221
E4.2	500	600	500	221
E6.2	900	1000	500	221
E6.2/f	-	1200	500	221

* 332.5 for voltages \leq 440V AC

Floor fixing

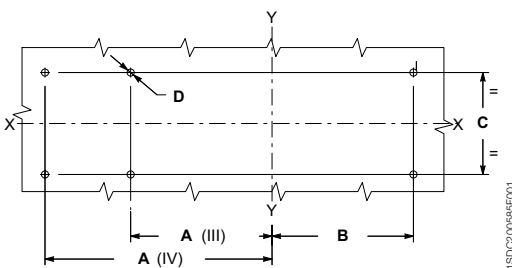

[mm]	A	B	C	D
E1.2	117	187	80	5.5
E2.2	154	244	150	10.5
E4.2	208	334	150	10.5
E6.2	460	460	150	10.5
E6.2/f	-	586	150	10.5

Wall fixing (only for E1.2)

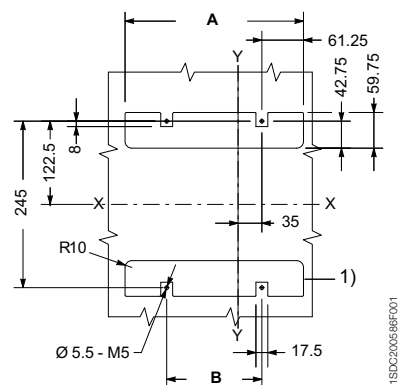

[mm]	3 p	4 p
A	192.5	262.5
B	70	140

1) for fixing with rear terminals

Earthing device E2.2 - E4.2 - E6.2

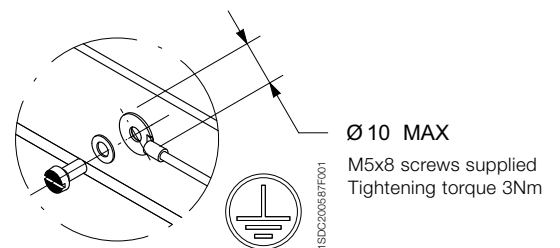

Dimensions

Fixed circuit-breaker - E1.2

Front terminals - F

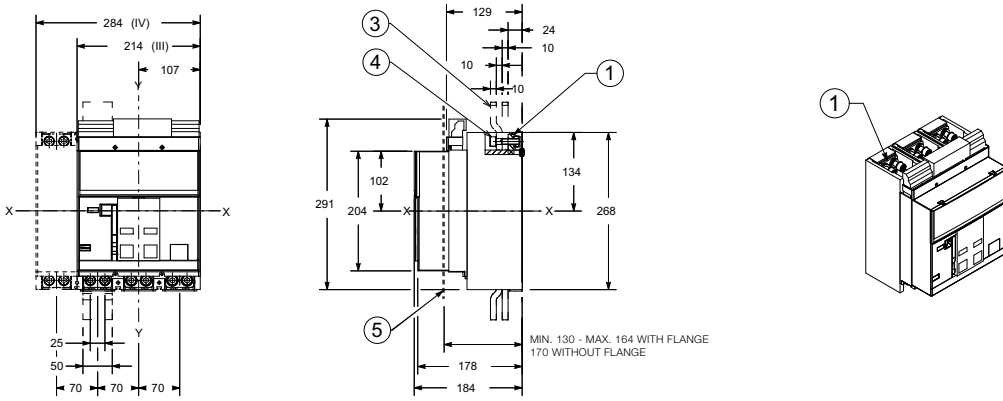

Extended front terminals - EF

7

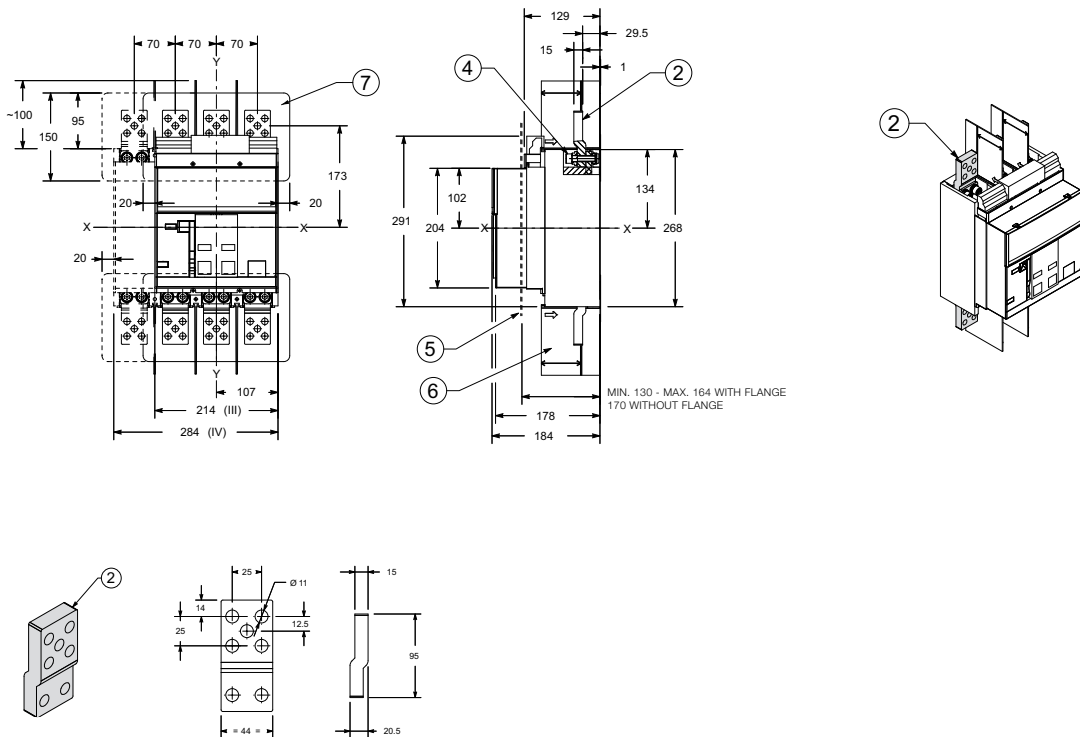

Key

- | | |
|---------------------------------------|--|
| 1 Front terminals for flat connection | 5 Door position - Ref. page 7/2 |
| 2 Extended front terminals | 6 Obligatory phase separators 100mm |
| 3 To be supplied by the customer | 7 Obligatory insulating plate to be supplied by the customer |
| 4 Tightening torque 18Nm | |

Orientable rear terminals - HR/VR

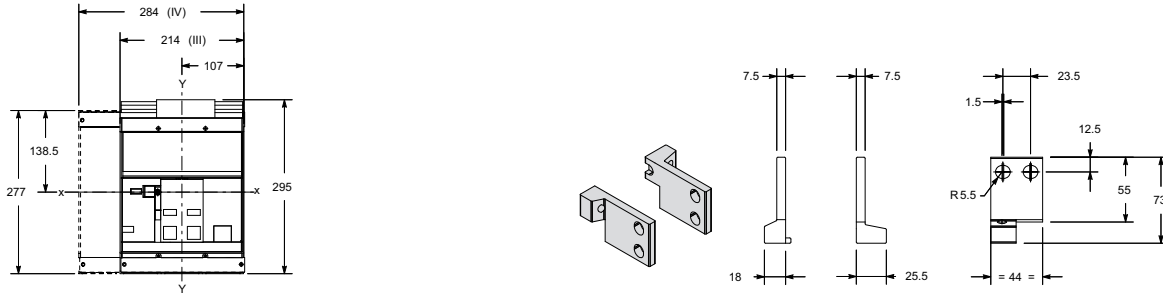

Terminals HR

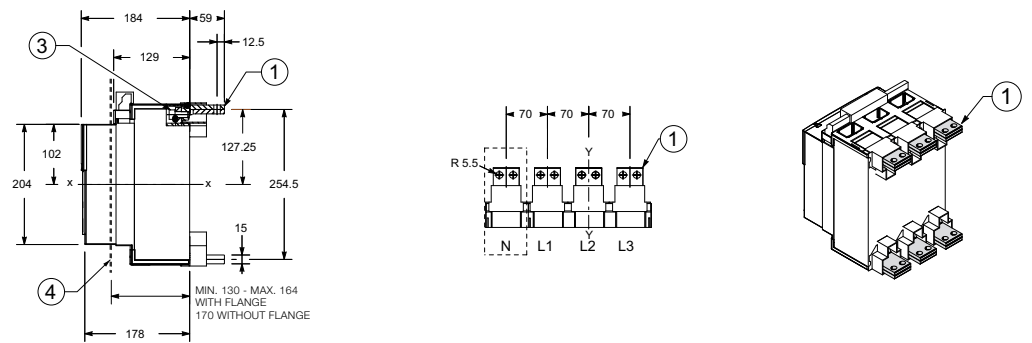

7

Terminals VR

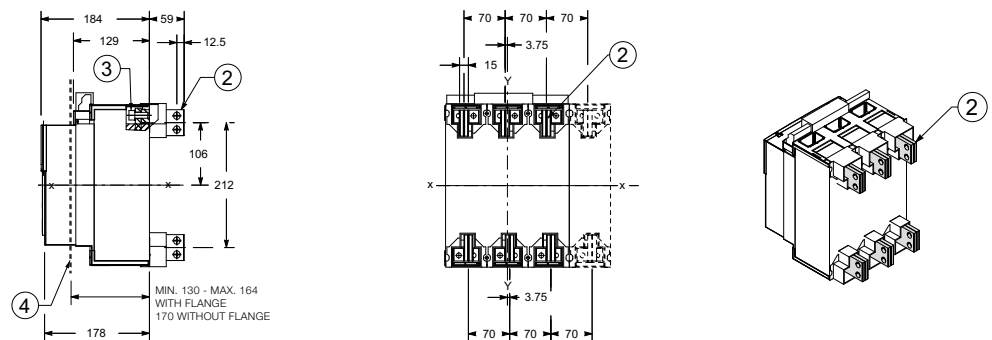

Key

- 1 Horizontal orientable terminals HR
- 2 Vertical orientable terminals VR
- 3 Tightening torque 20Nm
- 4 Door position - Ref. page 7/2

1SDC2000595F001

Dimensions

Fixed circuit-breaker - E1.2

Splayed extended front terminals - ES 3-pole version

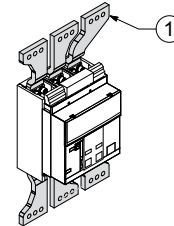
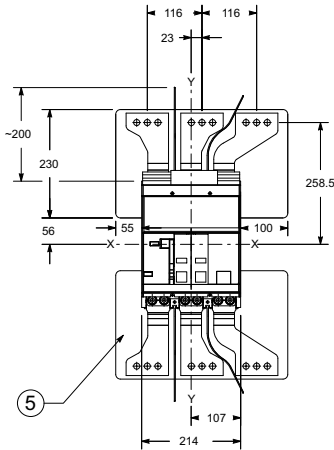

7

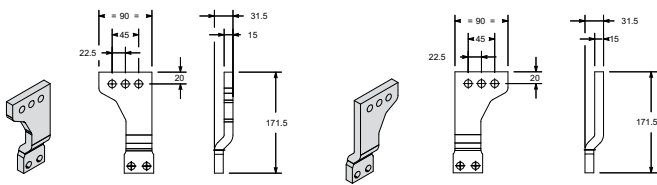

4-pole version

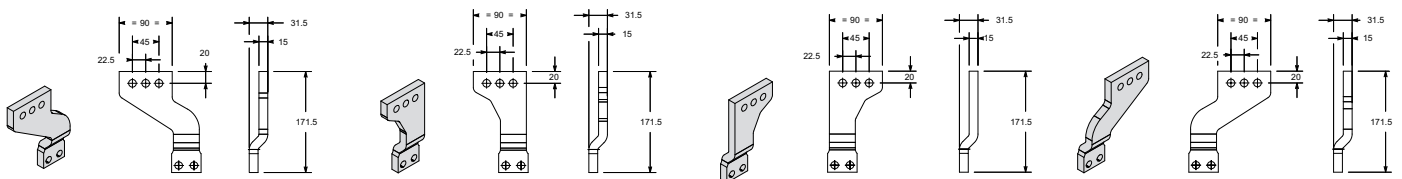
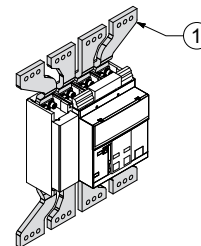
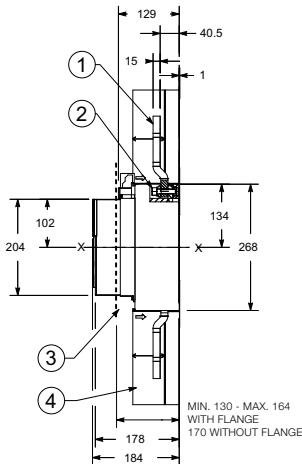
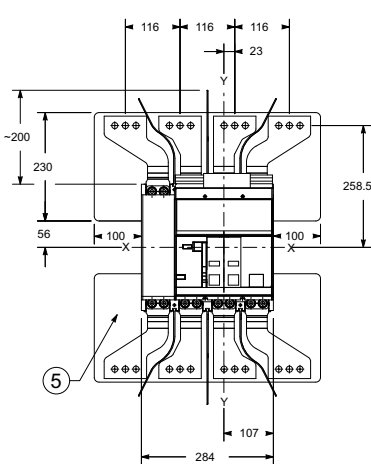

Key

- 1 Splayed extended front terminals
- 2 Tightening torque 18Nm
- 3 Door position - Ref. page 7/2
- 4 Obligatory phase separators 200mm
- 5 Obligatory insulating plate to be supplied by the customer

Front terminals for cables – FcCuAl

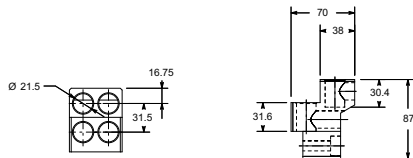
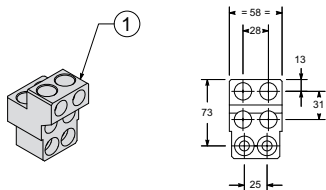
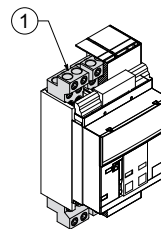
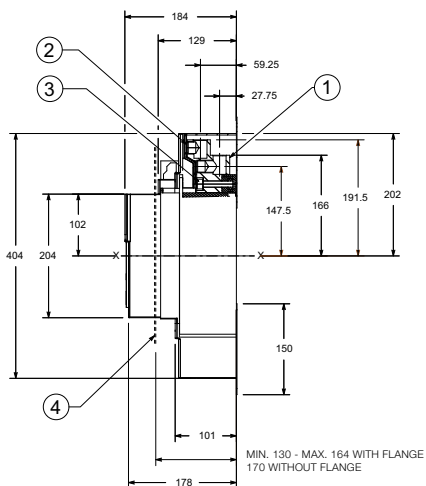
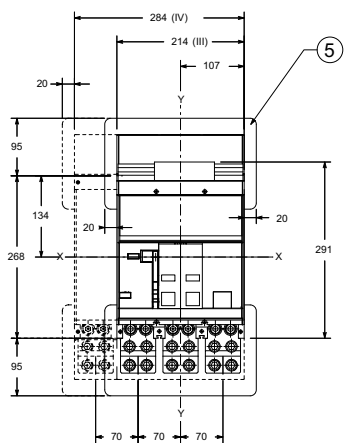

Key

- 1 Front terminals for cables FC CU AL
- 2 Tightening torque 43Nm
- 3 Tightening torque 18Nm
- 4 Door position - Ref. page 7/2
- 5 Obligatory insulating plate to be supplied by the customer

Dimensions

Fixed circuit-breaker - E2.2

Orientable rear terminals - HR/VR

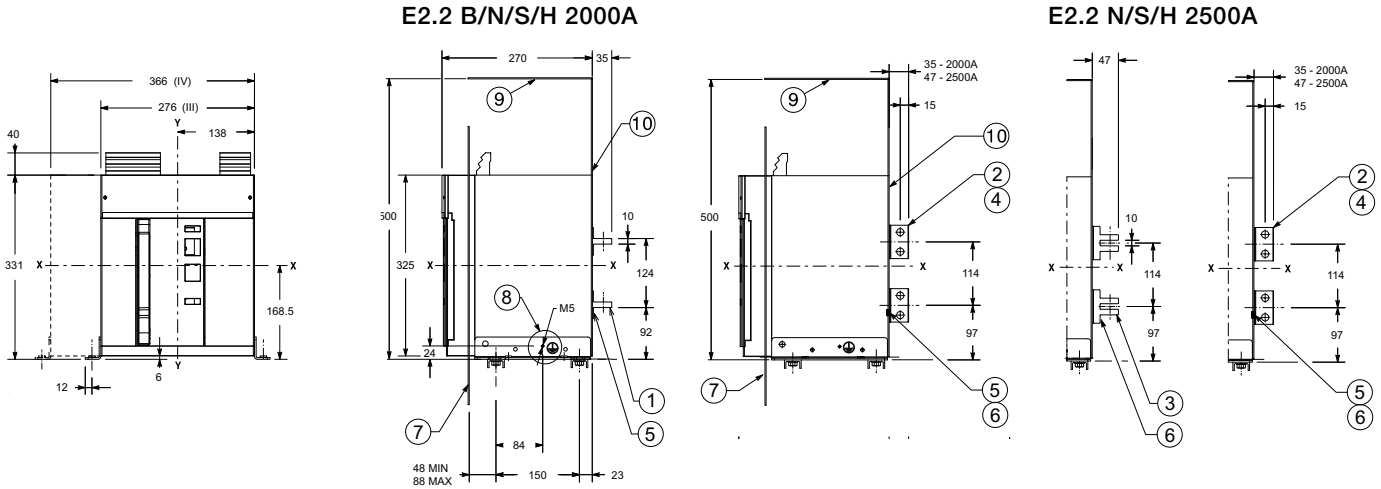

E2.2 B/N/S/H 2000A

7

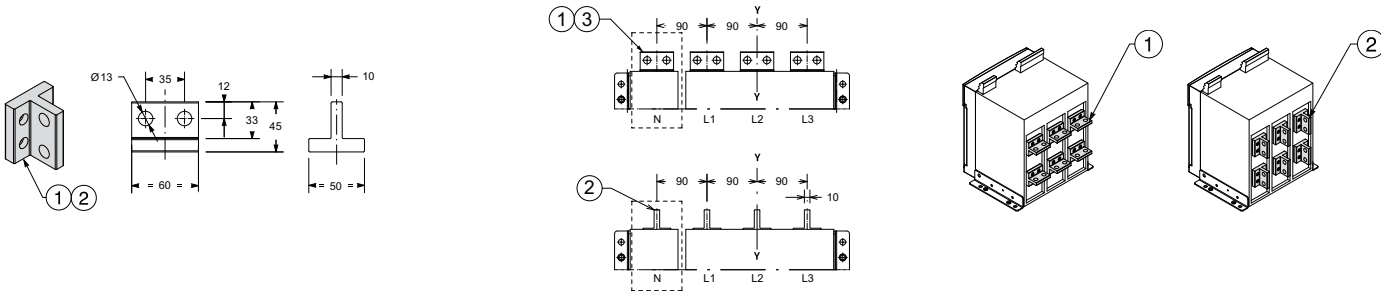

E2.2 N/S/H 2500A

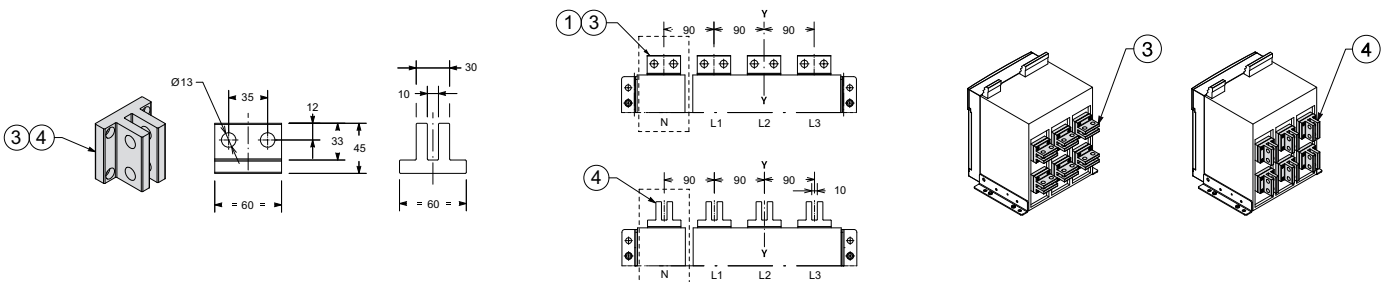

Key

- 1 Horizontal terminals 2000A
- 2 Vertical terminals 2000A
- 3 Horizontal terminals 2500A
- 4 Vertical terminals 2500A

- 5 Tightening torque 2000A 8.6Nm
- 6 Tightening torque 2500A 8.6Nm
- 7 Door position - Ref. page 7/2
- 8 Earthing device - Ref. page 7/3

- 9 Metallic sheet
- 10 Insulating sheet or insulated metallic sheet

Front terminals – F

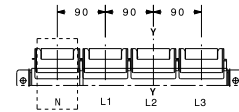
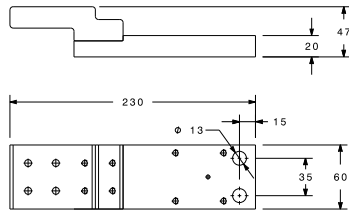
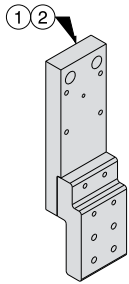
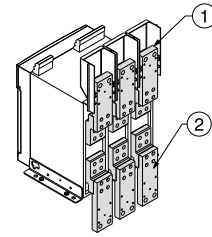
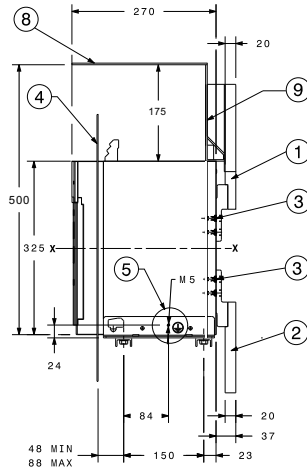
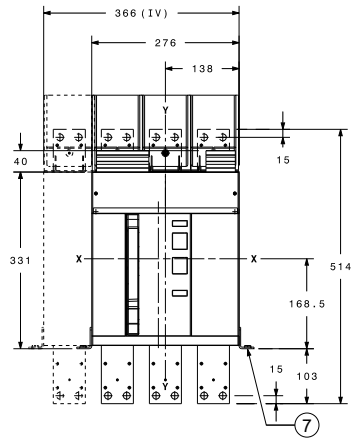

Key

- 1 Upper front terminals
- 2 Lower front terminals
- 3 Tightening torque 8.6Nm

- 4 Door position - Ref. page 7/2
- 5 Earthing device - Ref. page 7/3
- 7 External fixing point.
Recommended screws M10x25 high class

- 8 Metallic sheet
- 9 Insulating sheet or insulated metallic sheet

Dimensions

Fixed circuit-breaker - E2.2

Horizontal spread terminals – SHR

E2.2 B/N/S/H 2000A

E2.2 N/S/H 2500A

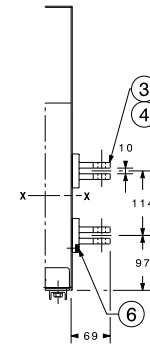
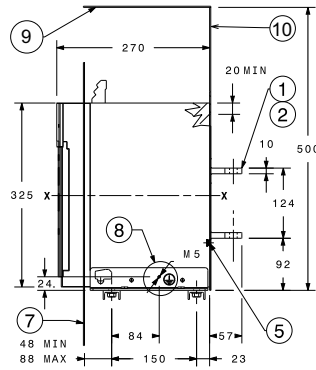
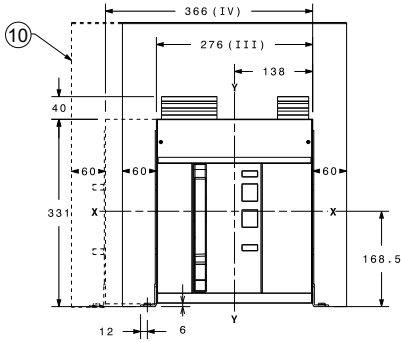

E2.2 B/N/S/H 2000A

7

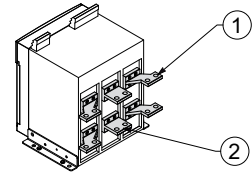
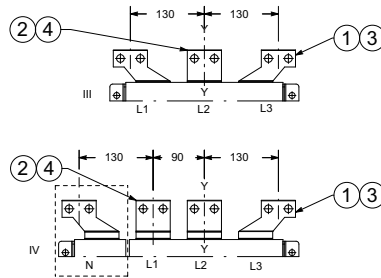
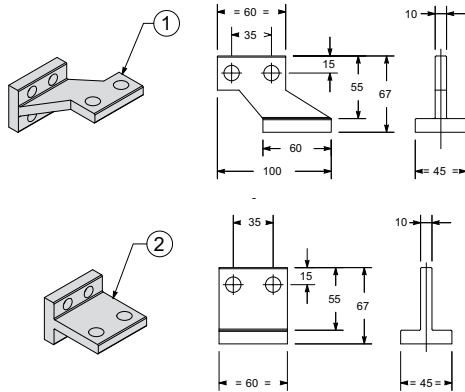

E2.2 N/S/H 2500A

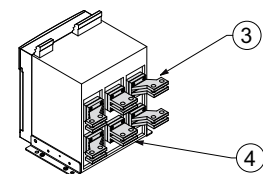
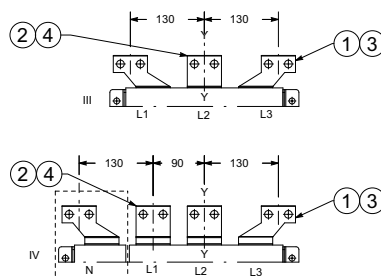
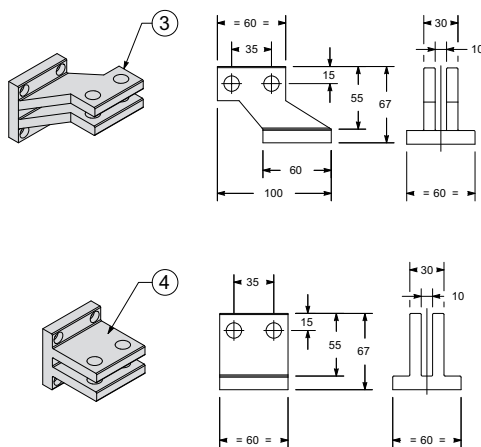

Key

- | | | |
|--|-----------------------------------|---|
| 1 Side horizontal splayed terminals 2000A | 5 Tightening torque 2000A 8.6Nm | 6 Metallic sheet |
| 2 Central horizontal splayed terminals 2000A | 6 Tightening torque 2500A 8.6Nm | 10 Insulating sheet or insulated metallic sheet |
| 3 Side horizontal splayed terminals 2500A | 7 Door position - Ref. page 7/2 | |
| 4 Central horizontal splayed terminals 2500A | 8 Earthing device - Ref. page 7/3 | |

Vertical spread terminals – SVR

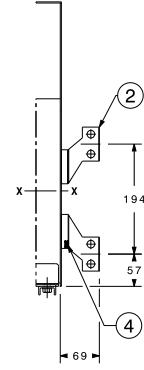
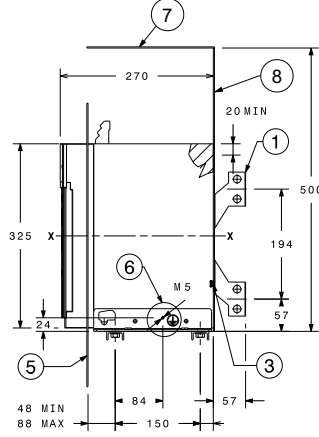
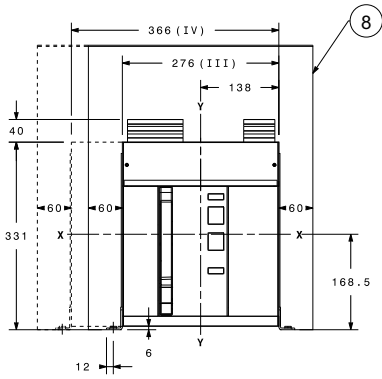

E2.2 B/N/S/H 2000A

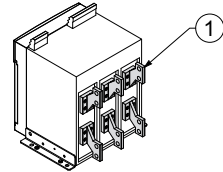
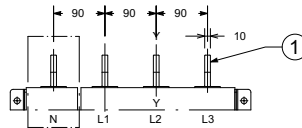
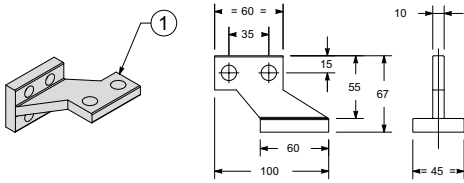

E2.2 N/S/H 2500A

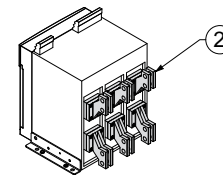
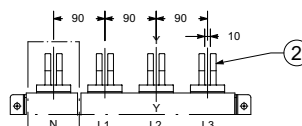
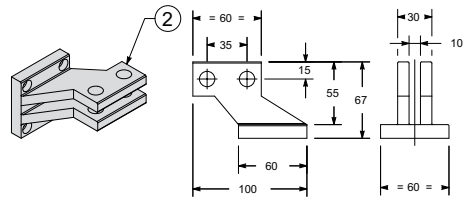

Key

- | | | |
|------------------------------------|-----------------------------------|--|
| 1 Vertical splayed terminals 2000A | 4 Tightening torque 2500A 8.6Nm | 7 Metallic sheet |
| 2 Vertical splayed terminals 2500A | 5 Door position - Ref. page 7/2 | 8 Insulating sheet or insulated metallic sheet |
| 3 Tightening torque 2000A 8.6Nm | 6 Earthing device - Ref. page 7/3 | |

Dimensions

Fixed circuit-breaker - E4.2

Orientable rear terminals - HR/VR

E4.2 N/S/H/V 3200A

E4.2 N/S/H/V 4000A

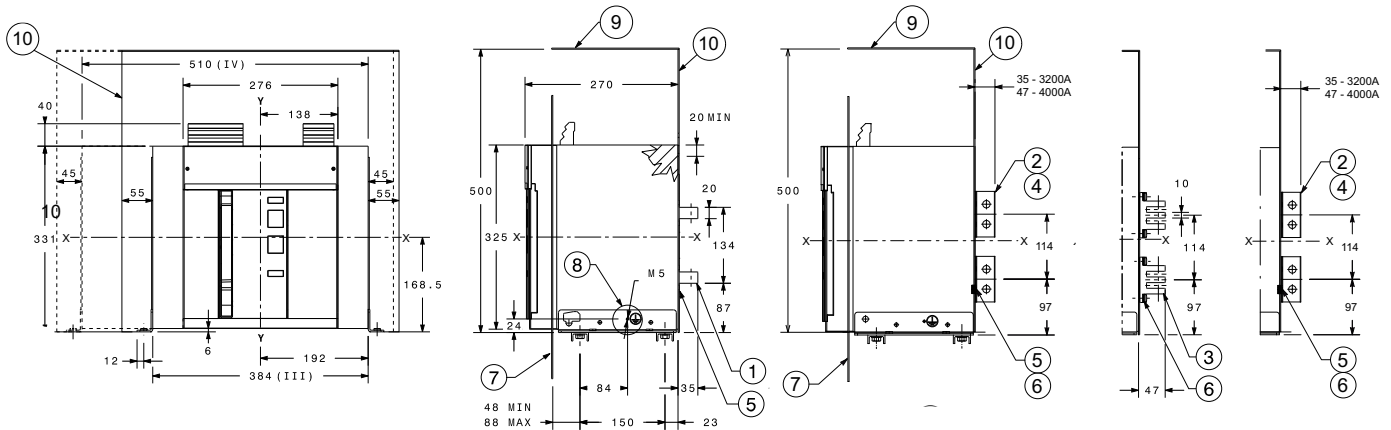

E4.2 N/S/H/V 3200A

7

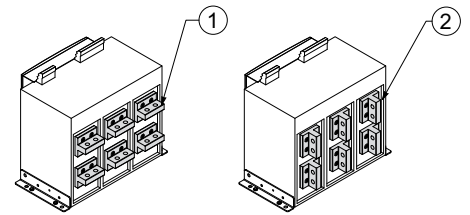
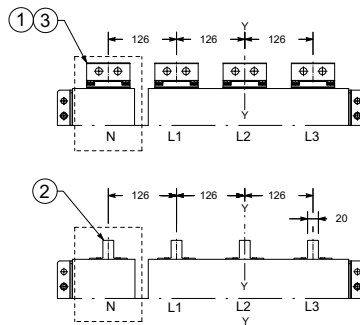
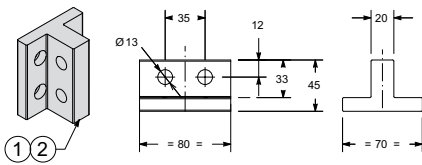

E4.2 N/S/H/V 4000A

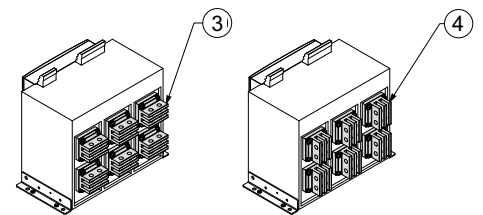
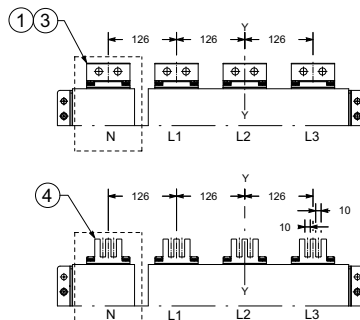
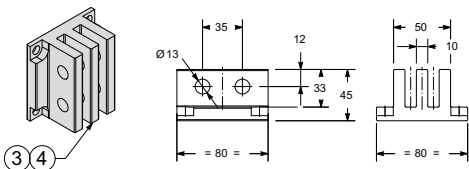

Key

- 1 Horizontal terminals 3200A
- 2 Vertical terminals 3200A
- 3 Horizontal terminals 4000A
- 4 Vertical terminals 4000A

- 5 Tightening torque 3200A 20Nm
- 6 Tightening torque 4000A 20Nm
- 7 Door position - Ref. page 7/2
- 8 Earthing device - Ref. page 7/3

- 9 Metallic sheet
- 10 Insulating sheet or insulated metallic sheet

Front terminals – F

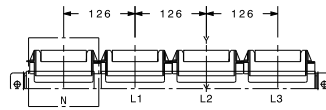
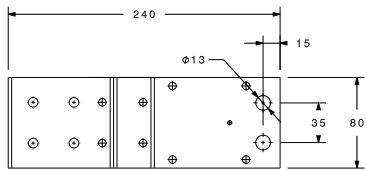
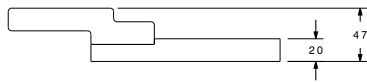
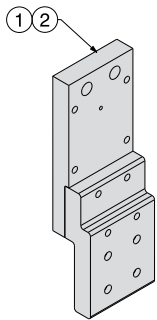
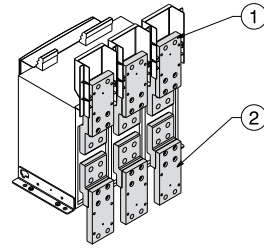
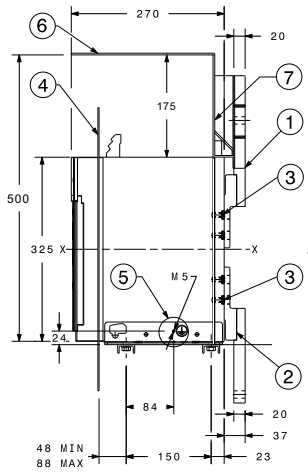
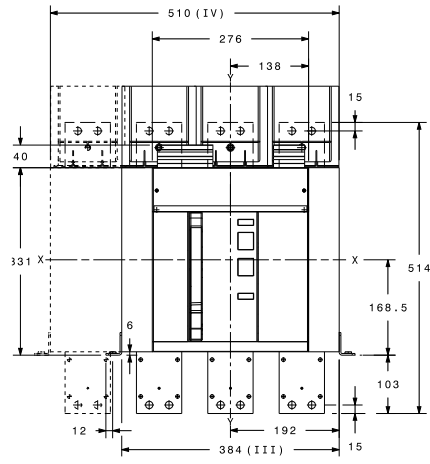

Key

- | | |
|---------------------------------|--|
| 1 Upper front terminals | 5 Earthing device - Ref. page 7/3 |
| 2 Lower front terminals | 6 Metallic sheet |
| 3 Tightening torque 8.6Nm | 7 Insulating sheet or insulated metallic sheet |
| 4 Door position - Ref. page 7/2 | |

Dimensions

Fixed circuit-breaker - E6.2

Horizontal rear terminals – HR

E6.2 H/V/X 4000-5000A

E6.2 H/V/X 6300A

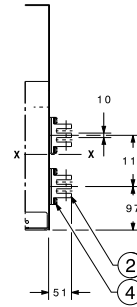
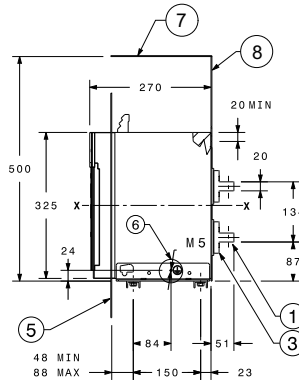
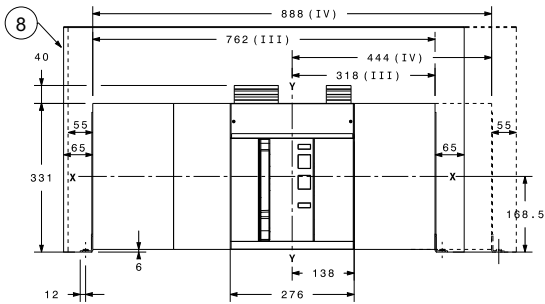

E6.2 H/V/X 4000-5000A

7

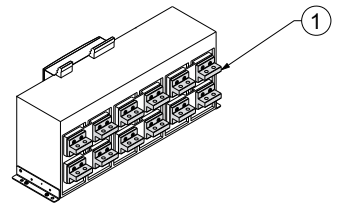
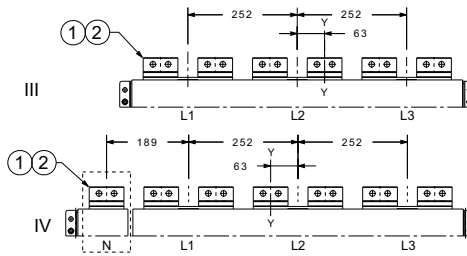
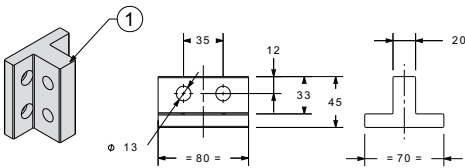

E6.2 H/V/X 6300A

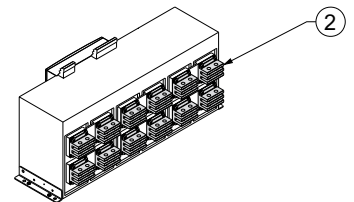
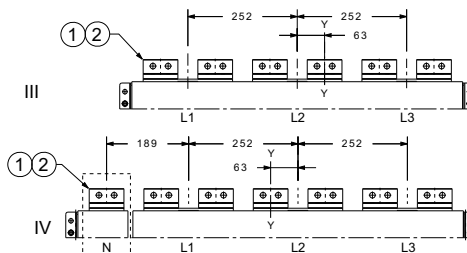
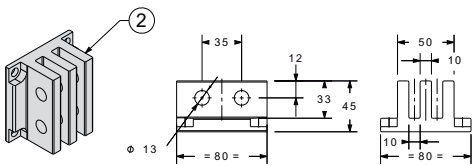

Key

- 1 Horizontal terminals 5000A
- 2 Horizontal terminals 6300A
- 3 Tightening torque 5000A 20Nm

- 4 Tightening torque 6300A 20Nm
- 5 Door position - Ref. page 7/2
- 6 Earthing device - Ref. page 7/3

- 7 Metallic sheet
- 8 Insulating sheet or insulated metallic sheet

Vertical rear terminals – VR

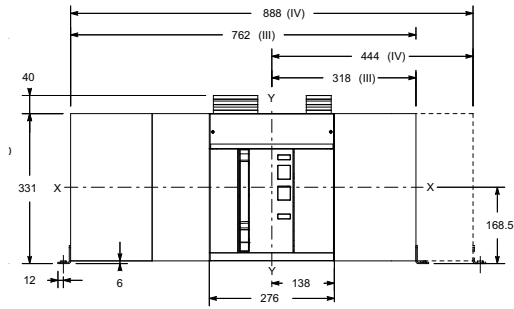

E6.2 H/V/X 4000...6300A

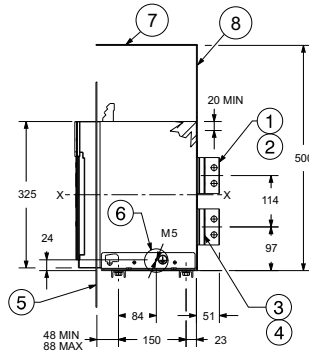

E6.2 H/V/X 4000-5000A

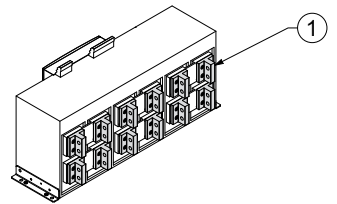
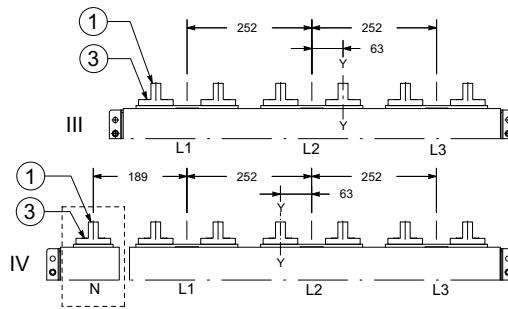
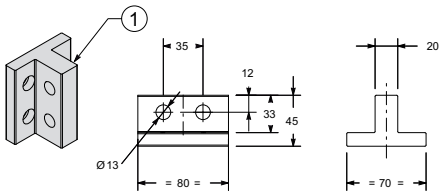

7

E6.2 H/V/X 6300A

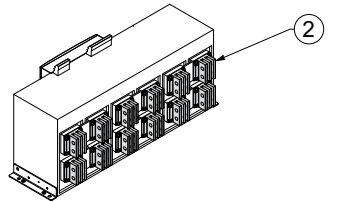
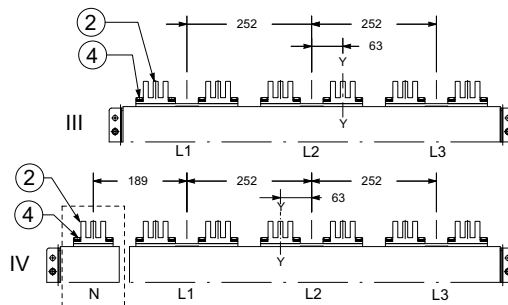
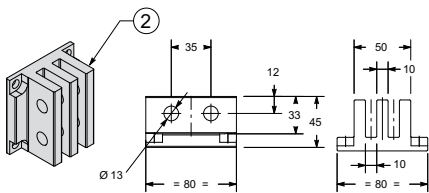

Key

- 1 Vertical terminals 5000A
- 2 Vertical terminals 6300A
- 3 Tightening torque 5000A 20Nm
- 4 Tightening torque 6300A 20Nm
- 5 Door position - Ref. page 7/2
- 6 Earthing device - Ref. page 7/3
- 7 Metallic sheet
- 8 Insulating sheet or insulated metallic sheet

1SDC200023D0203

Dimensions

Fixed circuit-breaker - E6.2

Orientable rear terminals - HR/VR full size

E6.2 H/V/X 4000-5000A

E6.2 H/V/X 6300A

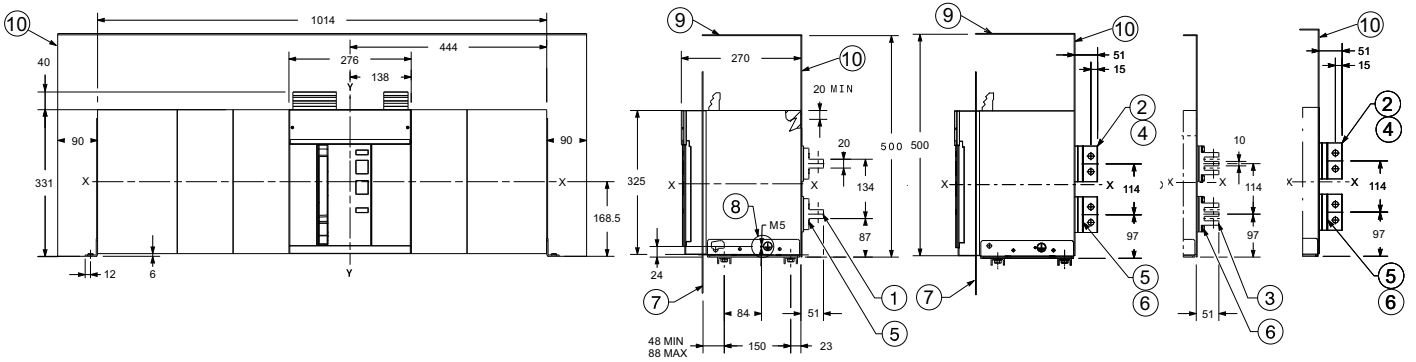

E6.2 H/V/X 4000-5000A

7

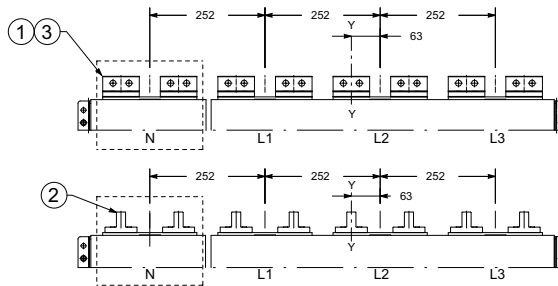
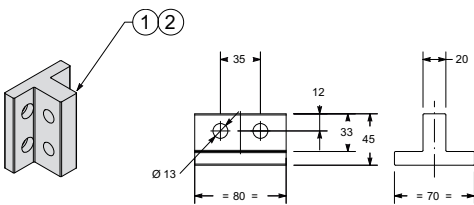

E6.2 H/V/X 6300A

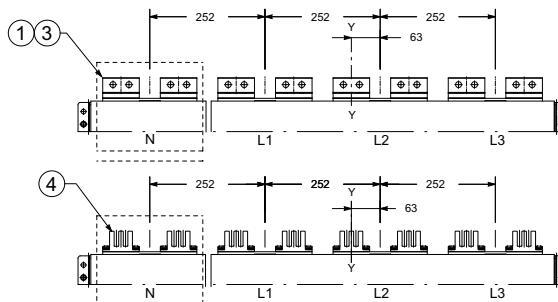
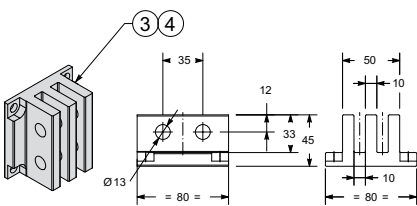

Key

- 1 Horizontal terminals 5000A
- 2 Vertical terminals 5000A
- 3 Horizontal terminals 6300A
- 4 Vertical terminals 6300A

- 5 Tightening torque 5000A 20Nm
- 6 Tightening torque 6300A 20Nm
- 7 Door position - Ref. page 7/2
- 8 Earthing device - Ref. page 7/3

- 9 Metallic sheet
- 10 Insulating sheet or insulated metallic sheet

Front terminals – F

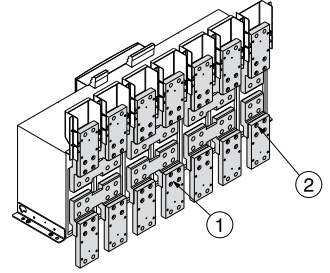
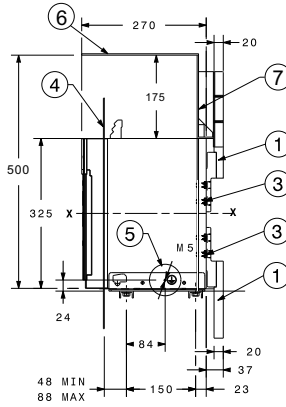
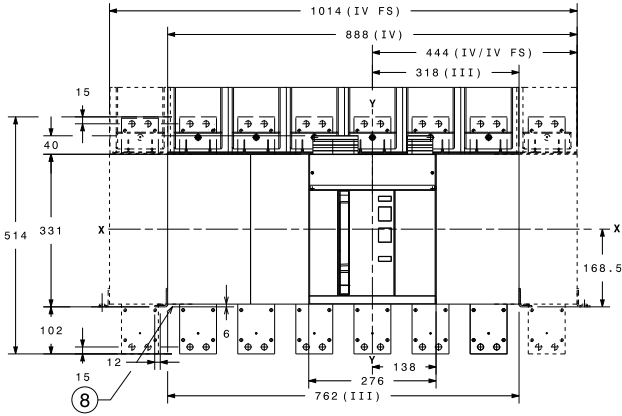

Upper front terminals

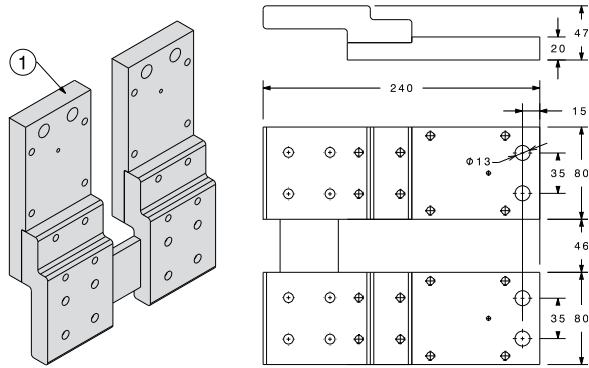

Lower front terminal

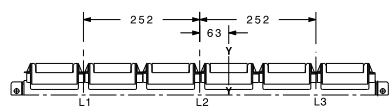
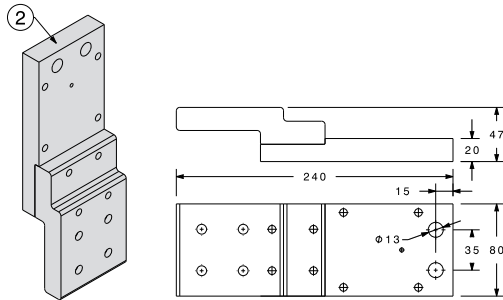

3-pole

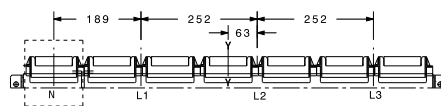

4-pole

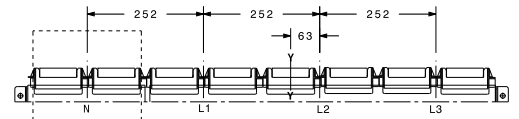

4-pole full size

Key

- | | | |
|---------------------------------|--|--------------------------|
| 1 Upper front terminals | 5 Earthing device - Ref. page 7/3 | 6 External fixing point. |
| 2 Lower front terminals | 7 Metallic sheet | Recommened screws M10x25 |
| 3 Tightening torque 20Nm | 8 Insulating sheet or insulated metallic sheet | high class |
| 4 Door position - Ref. page 7/2 | | |

Dimensions

Withdrawable circuit-breaker

E1.2

E2.2 - E4.2 - E6.2

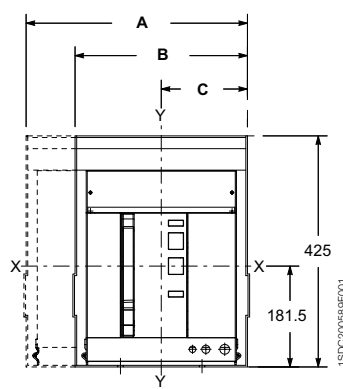
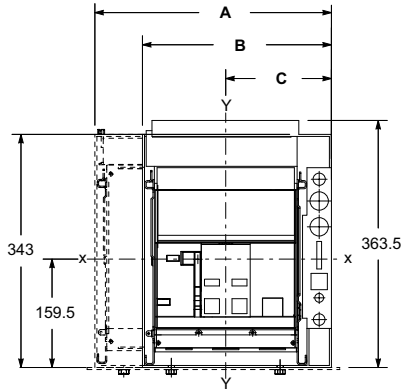

[mm]	A	B	C	
	4p	3p	3p	4p
E1.2	348	278	155.5	155.5
E2.2	407	317	158.5	158.5
E4.2	551	425	212.5	212.5
E6.2	929	803	338.5	464.5
E6.2/f	1055	-	-	464.5

7

Compartment door drilling

E1.2

E2.2 - E4.2 - E6.2

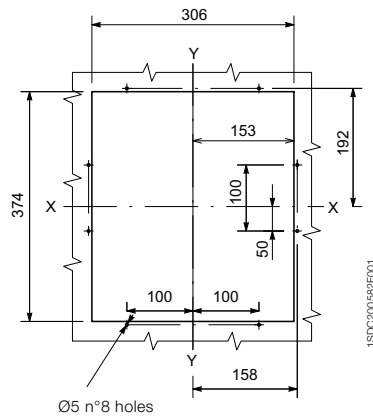
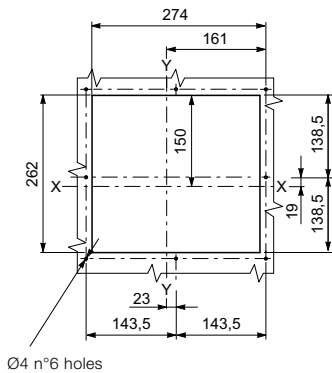

Distance from connected to isolated position

E1.2

E2.2 - E4.2 - E6.2

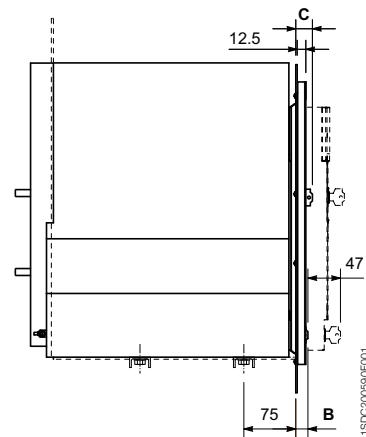
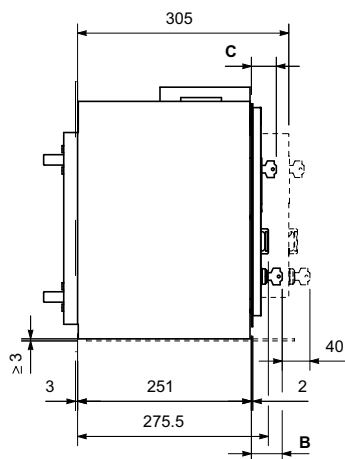

E1.2	Standard	Ronis/Profalux	Kirk	Castell
B [mm]	44.5	55	55	85
C [mm]	36	46.5	46.5	76.5

E2.2-E4.2-E6.2	Standard	Ronis/Profalux	Kirk	Castell
B [mm]	17.5	28	32	-
C [mm]	24	34.5	38.5	-

B refers to KLC; C refers to KLP

Dimensions of the compartment

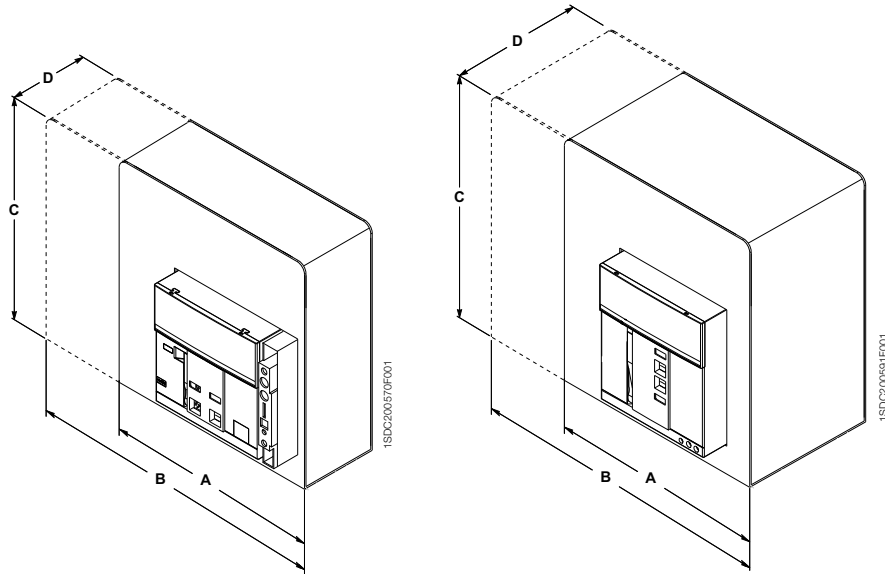

[mm]	A	B	C	D
	3p	4p		
E1.2	280	350	440*	252
E2.2	400	490	500	355
E4.2	500	600	500	355
E6.2	900	1000	500	355
E6.2/f	-	1200	500	355

* 390 for voltages ≤ 440V AC

Floor fixing

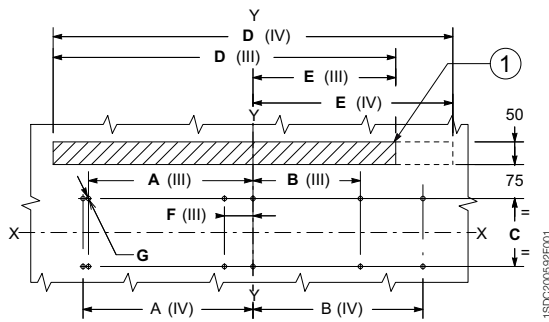

[mm]	A		B		C	D		E		F	G
	3p	4p	3p	4p		3p	4p	3p	4p		
E1.2	80	150	80	80	100	-	-	-	-	-	9
E2.2	75	175	75	75	150	270	360	135	135	-	10
E4.2	100	225	100	100	150	378	504	189	189	-	10
E6.2	363	375	237	375	150	756	882	315	441	63	10
E6.2/f	-	425	-	425	150	1008:			441	-	10

Key

- 1 Ventilation drilling on the switchgear

Earthing device E2.2 - E4.2 - E6.2

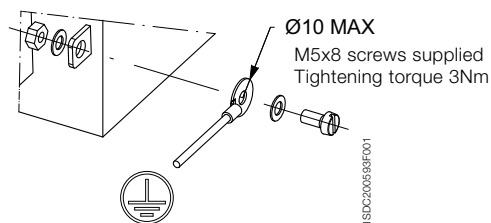

Fixing on support sheet (only for E1.2)

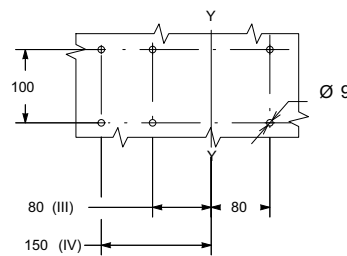

Dimensions

Withdrawable circuit-breaker - E1.2

Rear orientable terminals - HR/VR

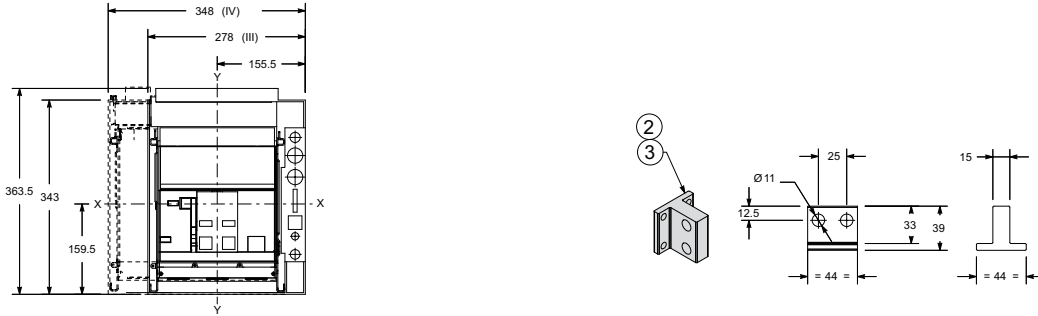

Terminals HR

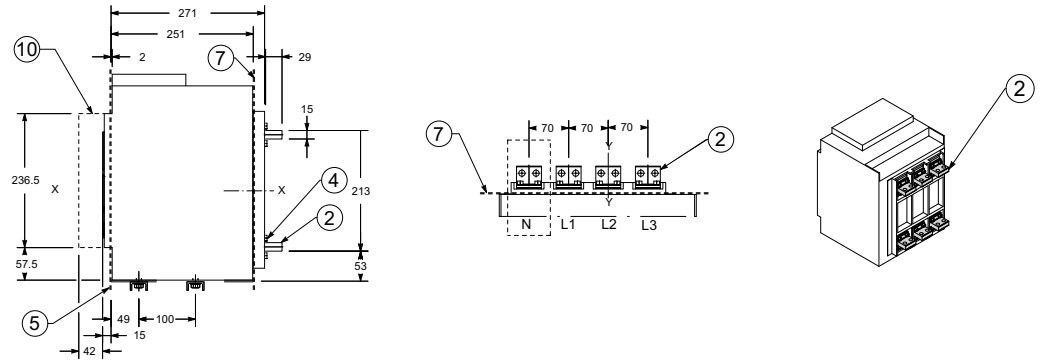

Terminals VR

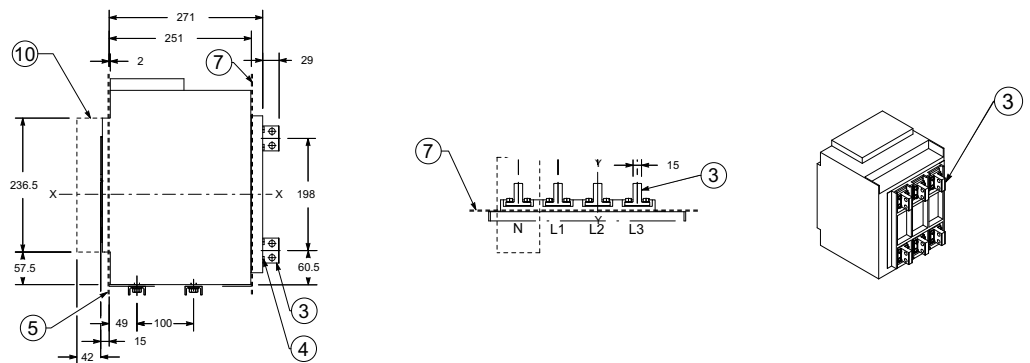

Key

- 2 Horizontal rear terminals
- 3 Vertical rear terminals
- 4 Tightening torque 12 Nm
- 5 Door position - Ref. page 7/18
- 7 Rear segregation for rear terminals
- 10 Sectioning run

Extended front terminals – EF

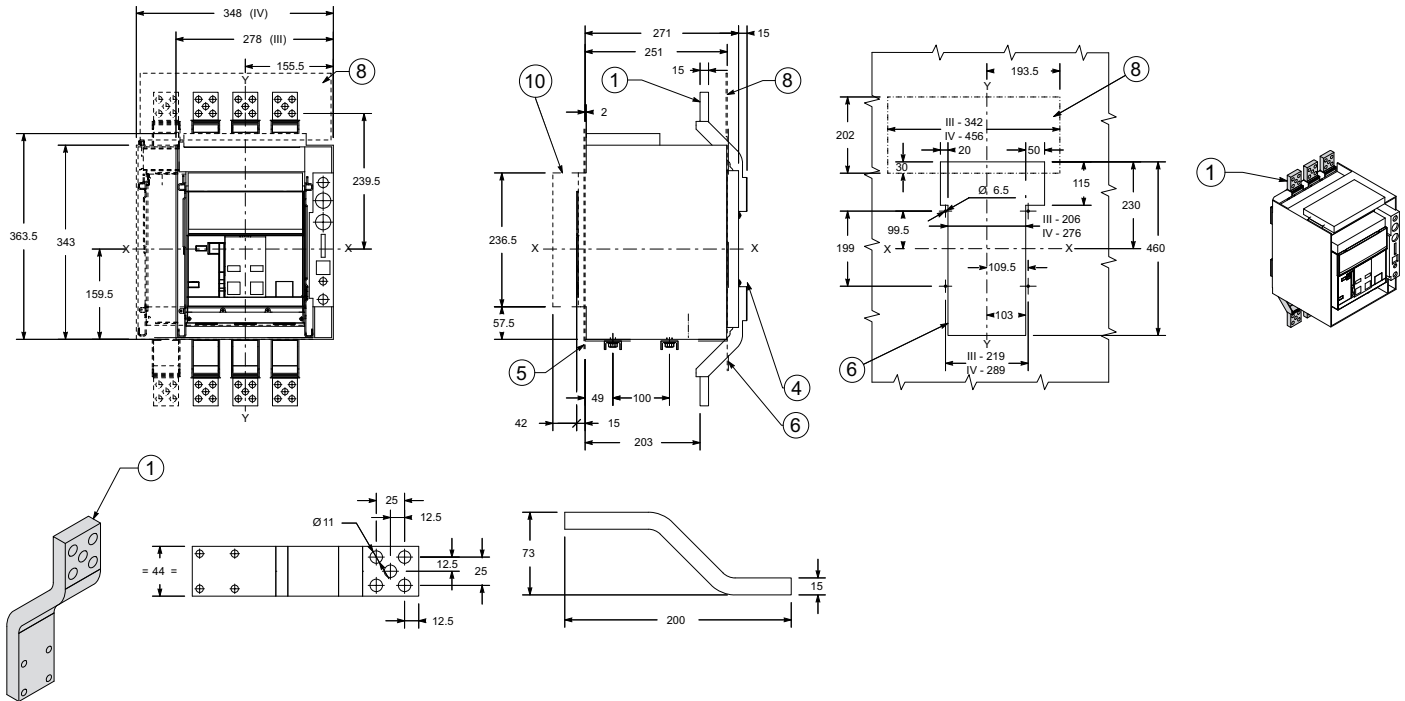

Rear terminals for cables – FcCuAl

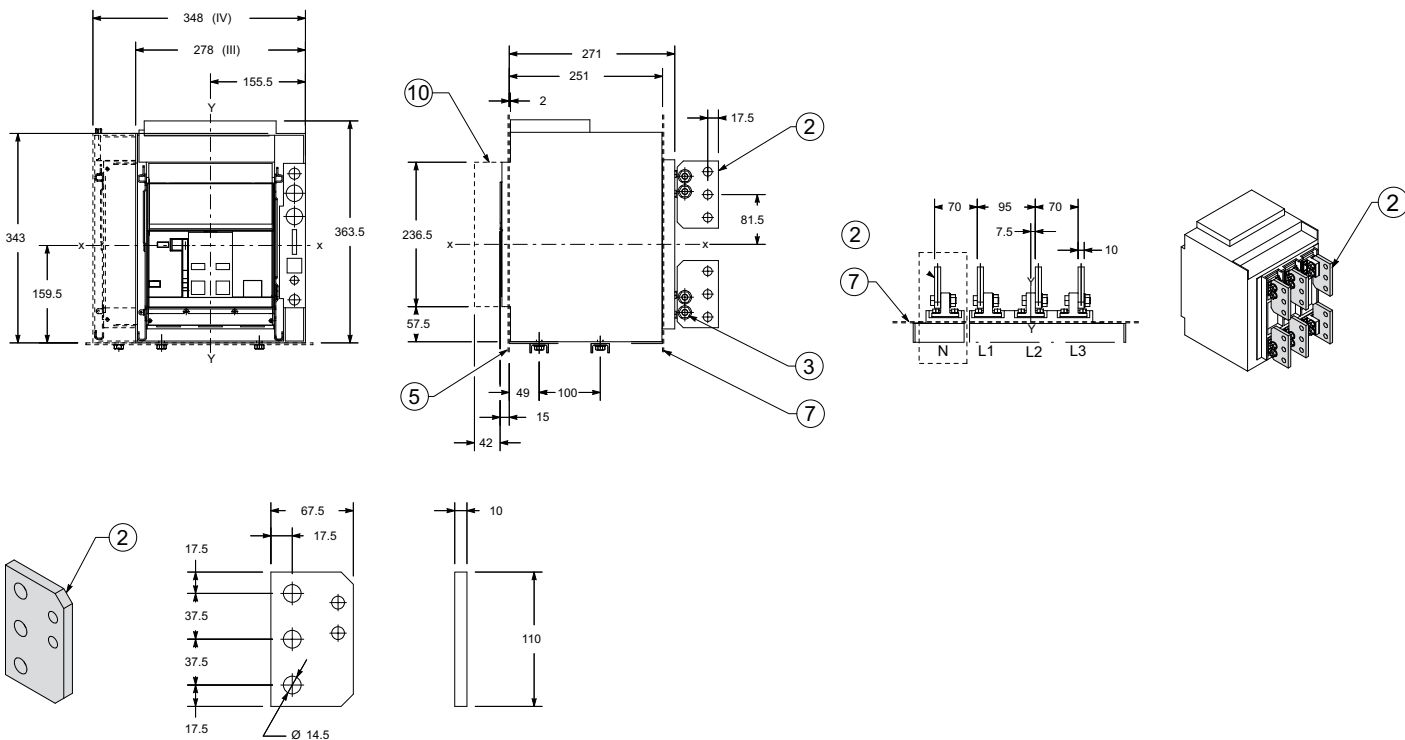

Key

- 1 Front terminals
- 2 Rear terminals for cables
- 3 Tightening torque 48 Nm
- 4 Tightening torque 12 Nm
- 5 Door position - Ref. page 7/18
- 6 Rear segregation for front terminals
- 7 Rear segregation for rear terminals - Ref. page 7/21
- 8 Insulating protection
- 10 Sectioning run

1SDC200023D0203

Dimensions

Withdrawable circuit-breaker - E1.2

Front spread terminals - ES 3-pole version

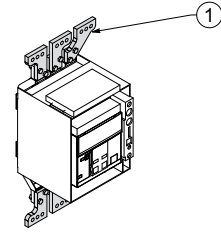
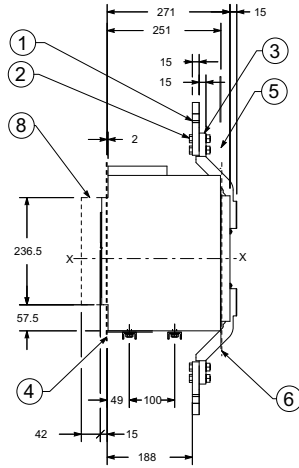
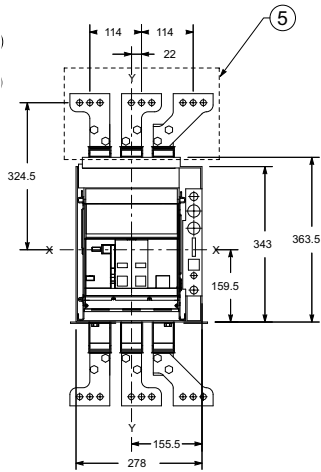

7

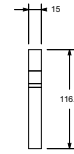
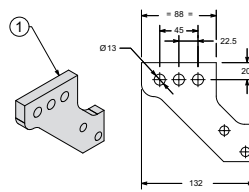
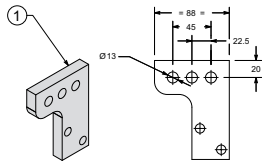
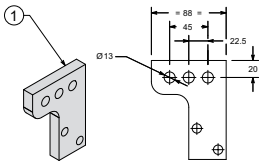

4-pole version

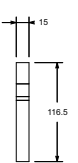
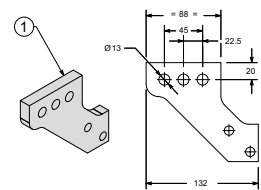
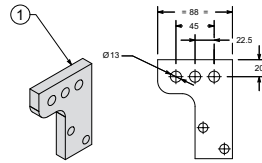
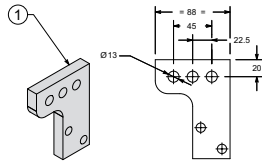
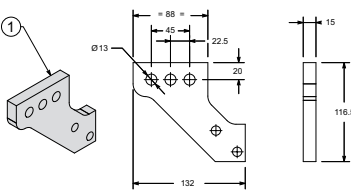
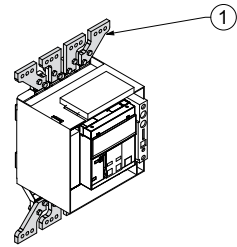
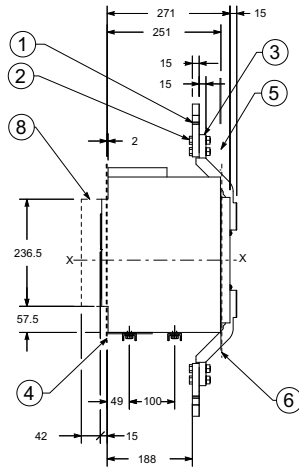
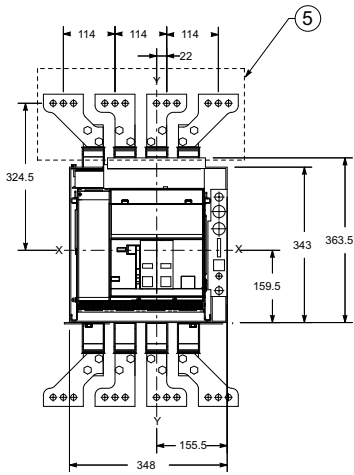

Key

- 1 Spread terminal
- 2 Tightening torque 40 Nm
- 3 Front terminal
- 4 Door position - Ref. page 7/18
- 5 Insulating protection (refer to front terminals page 7/21)
- 6 Rear segregation for front terminals - Ref. page 7/21
- 8 Sectioning run

Horizontal rear spread terminals – SHR

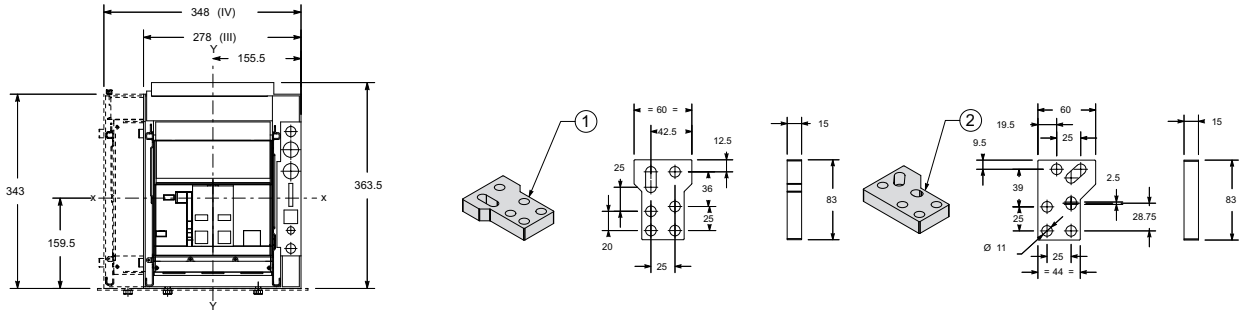

3-pole version

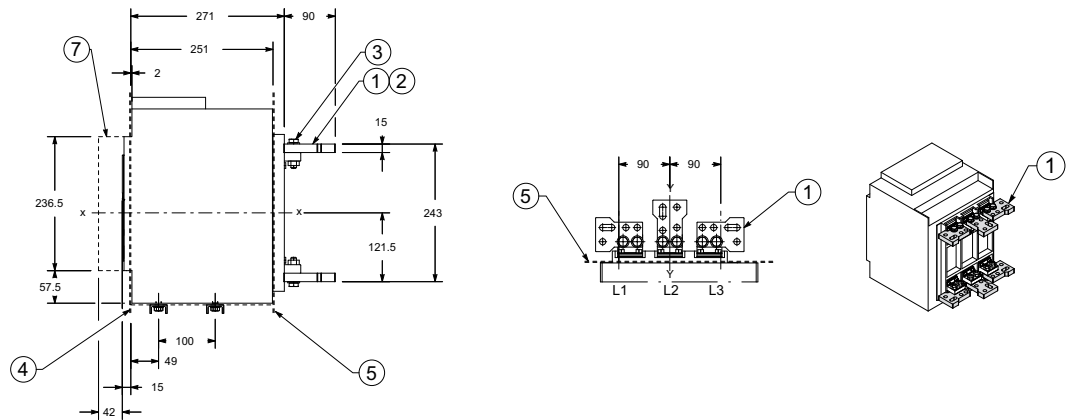

4-pole version

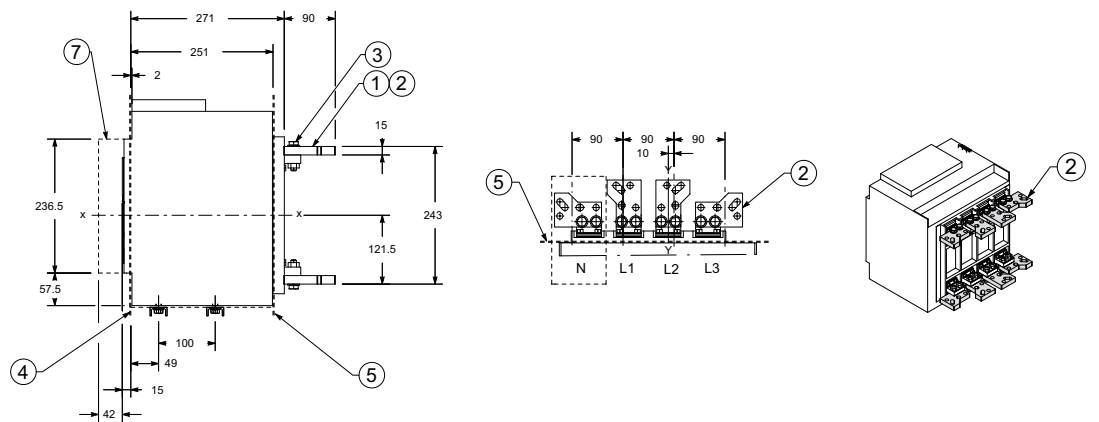

Key

- | | |
|--|--------------------------------------|
| 1 Spread rear terminals for 3-pole version | 4 Door position - Ref. page 7/18 |
| 2 Spread rear terminals for 4-pole version | 5 Rear segregation of rear terminals |
| 3 Tightening torque 18 Nm | 7 Sectioning run |

Dimensions

Withdrawable circuit-breaker - E2.2

Rear orientable terminals - HR/VR

E2.2 B/N/S/H 2000A

E2.2 N/S/H 2500A

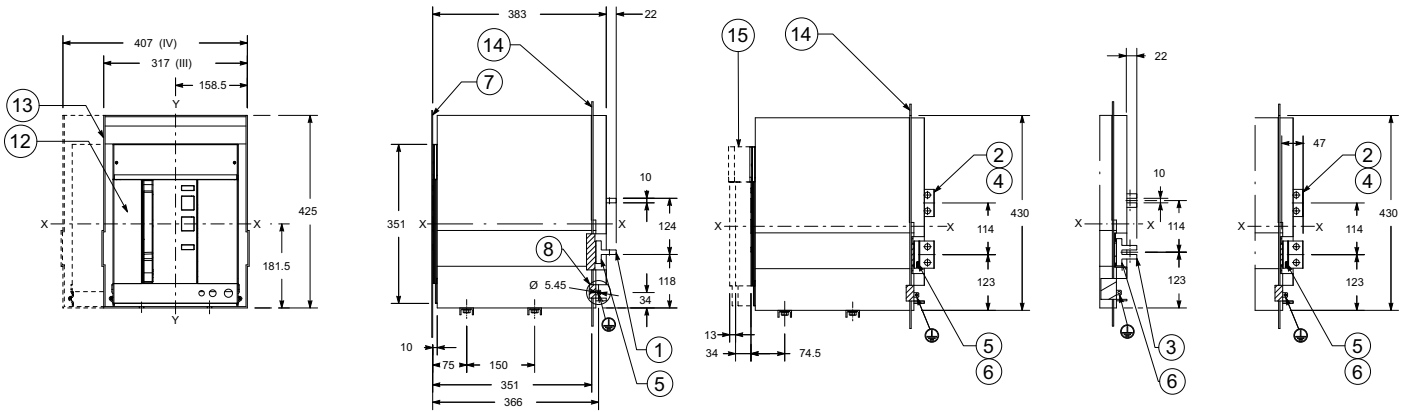

7

E2.2 B/N/S/H 2000A

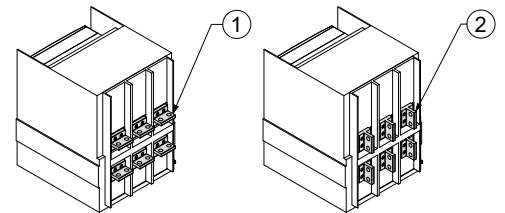
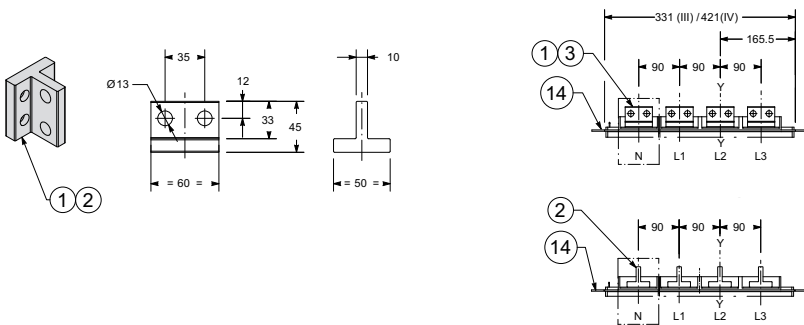

E2.2 N/S/H 2500A

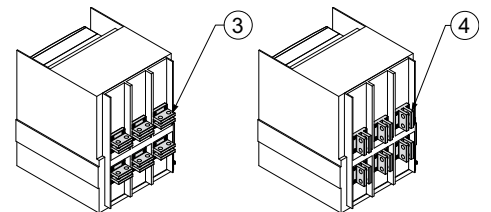
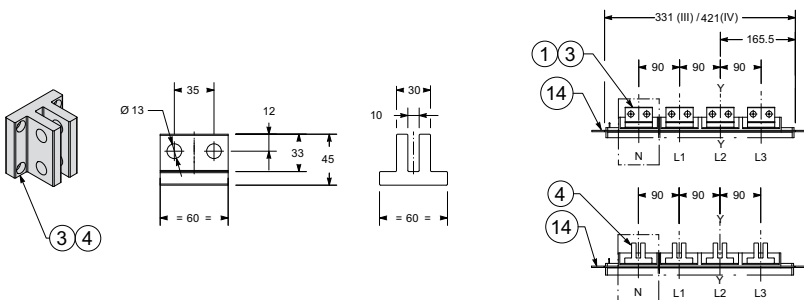

Key

- | | | |
|------------------------------|----------------------------------|--|
| 1 Horizontal terminals 2000A | 5 Tightening torque 2000A 8.6Nm | 12 Mobile part |
| 2 Vertical terminals 2000A | 6 Tightening torque 2500A 8.6Nm | 13 Fixed part |
| 3 Horizontal terminals 2500A | 7 Door position - Ref. page 7/19 | 14 Segregation (where envisaged) |
| 4 Vertical terminals 2500A | 8 Earthing device | 15 Distance from connected for testing to isolated |

Front terminals – F

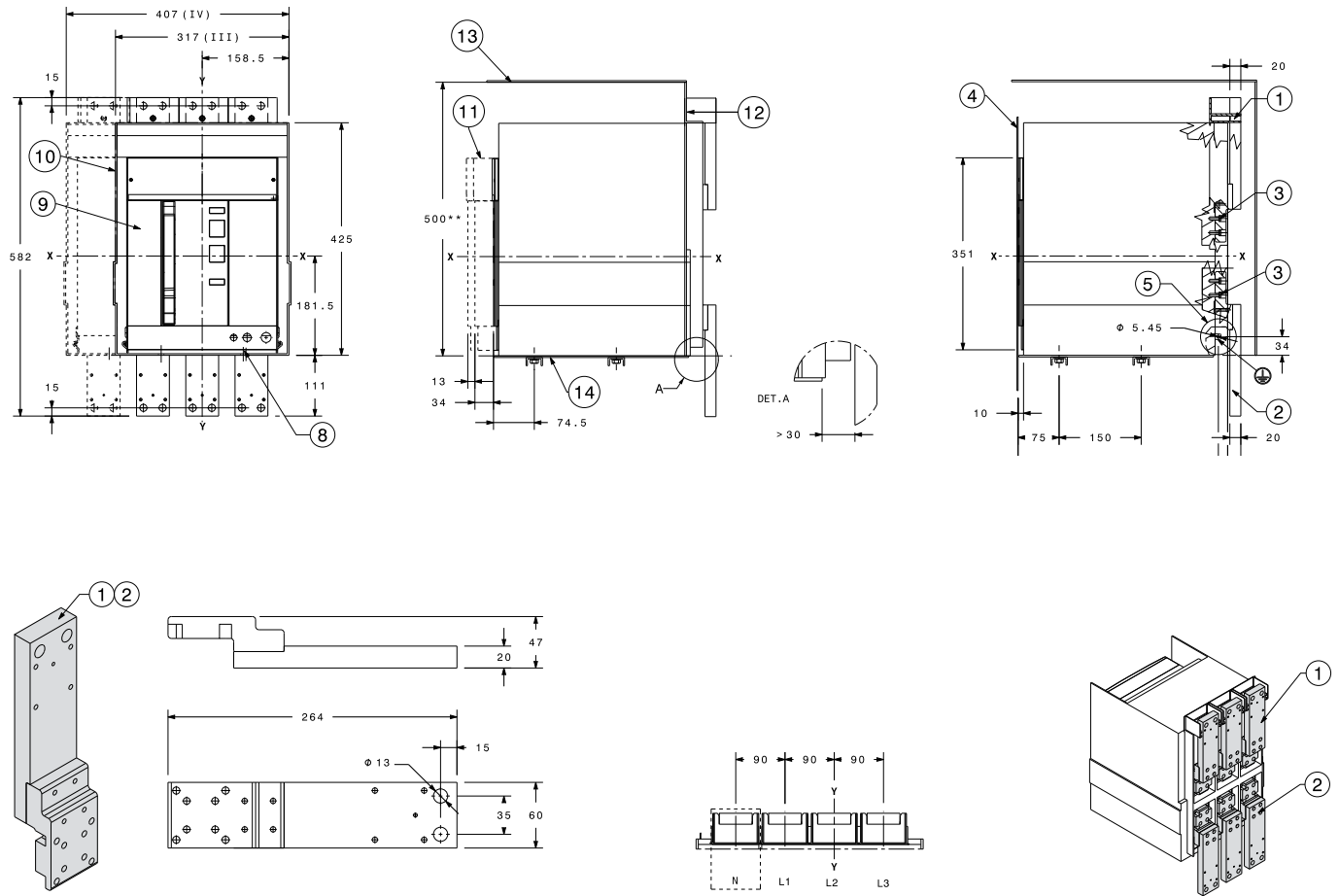

- Key**
- | | | |
|----------------------------------|--|---|
| 1 Upper front terminals | 8 External fixing point.
Reccomended screws M10x25 high class | 11 Connected, test, disconnected distances |
| 2 Lower front terminals | 9 Moving part | 12 Insulating sheet or insulated metallic sheet |
| 3 Tightening torque 8.6Nm | 10 Fixed part | 13 Roof insulation or insulated metal |
| 4 Door position - Ref. page 7/19 | | 14 Fixing plate |
| 5 Earthing device | | |

Dimensions

Withdrawable circuit-breaker - E2.2

Horizontal rear spread terminals – SHR

E2.2 B/N/S/H 2000A

E2.2 N/S/H 2500A

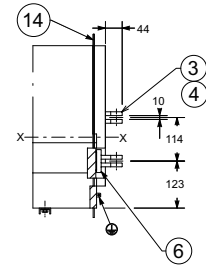
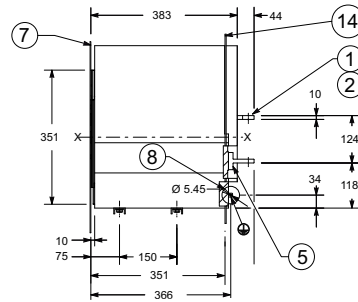
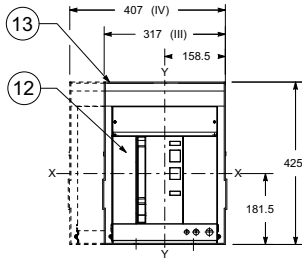

E2.2 B/N/S/H 2000A

7

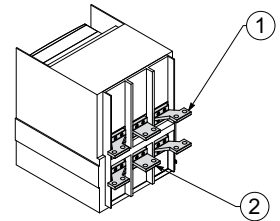
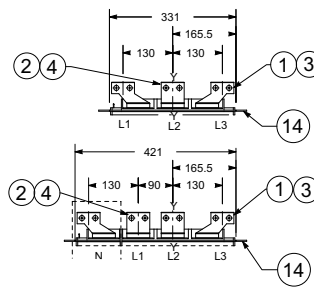
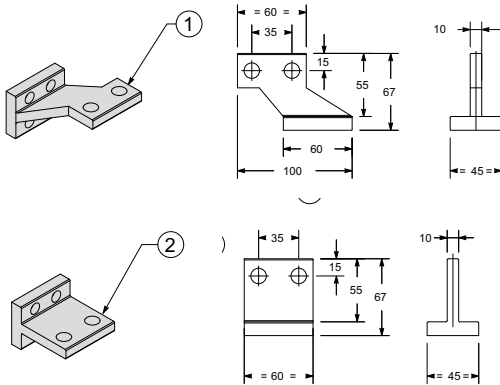

E2.2 N/S/H 2500A

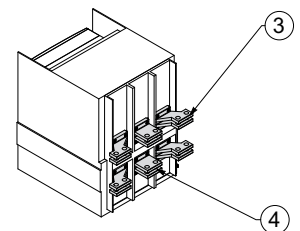
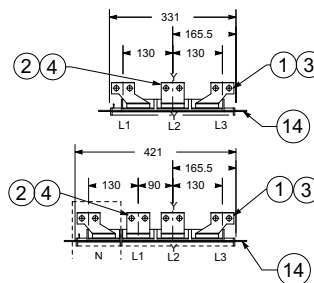
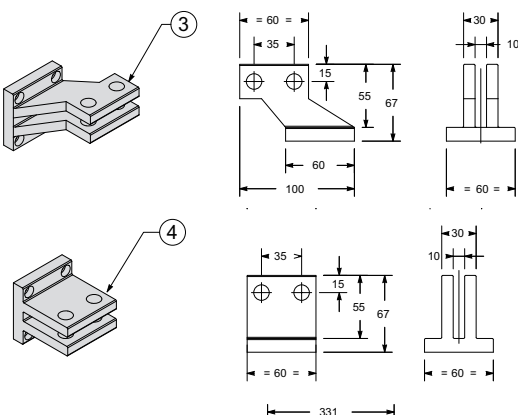

Key

- | | | |
|--|----------------------------------|----------------------------------|
| 1 Side horizontal splayed terminals 2000A | 5 Tightening torque 2000A 8.6Nm | 12 Mobile part |
| 2 Central horizontal splayed terminals 2000A | 6 Tightening torque 2500A 8.6Nm | 13 Fixed part |
| 3 Side horizontal splayed terminals 2500A | 7 Door position - Ref. page 7/19 | 14 Segregation (where envisaged) |
| 4 Central horizontal splayed terminals 2500A | 8 Earthing device | |

Vertical rear spread terminals – SVR

E2.2 B/N/S/H 2000A

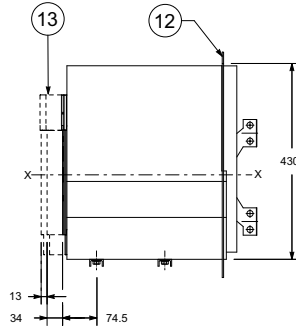
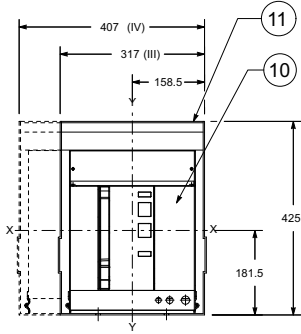

E2.2 N/S/H 2500A

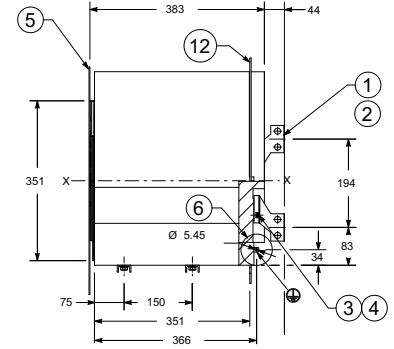

E2.2 B/N/S/H 2000A

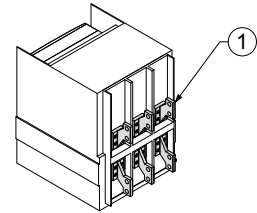
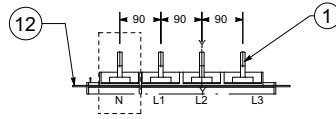
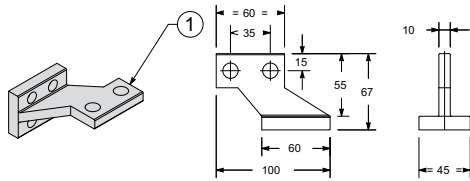

E2.2 N/S/H 2500A

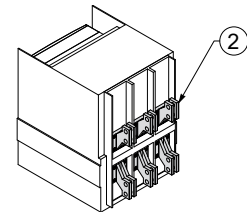
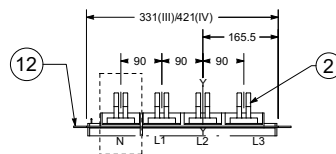
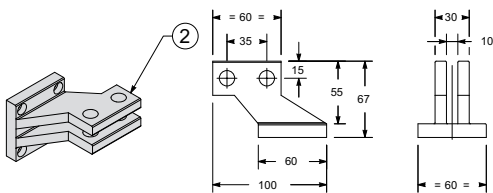

Key

- 1 Vertical splayed terminals 2000A
- 2 Vertical splayed terminals 2500A
- 3 Tightening torque 2000A 8.6Nm
- 4 Tightening torque 2500A 8.6Nm
- 5 Door position - Ref. page 7/19
- 6 Earthing device
- 10 Mobile part
- 11 Fixed part
- 12 Segregation (where envisaged)
- 13 Distance from connected for testing to isolated

Dimensions

Withdrawable circuit-breaker - E4.2

Rear orientable terminals - HR/VR

E4.2 N/S/H 3200A

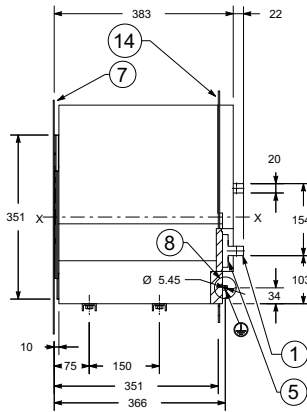
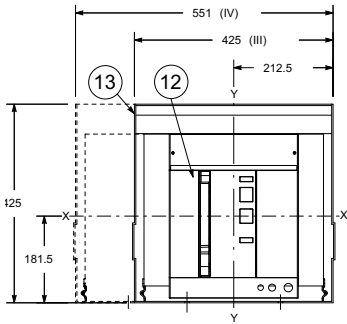

E4.2 N/S/H 4000A
E4.2 V 2000...4000A

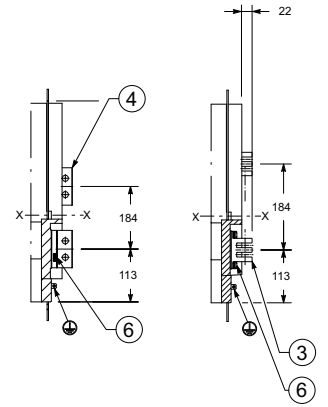

E4.2 N/S/H 3200A

7

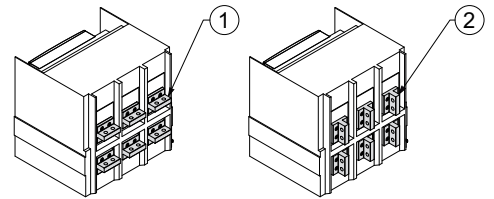
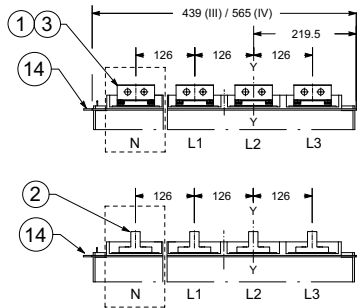
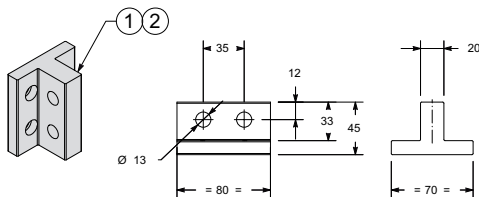

E4.2 N/S/H 4000A
E4.2 V 2000...4000A

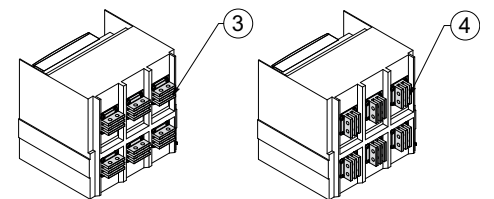
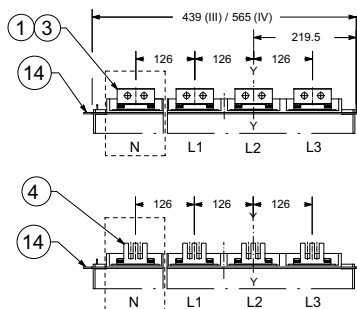
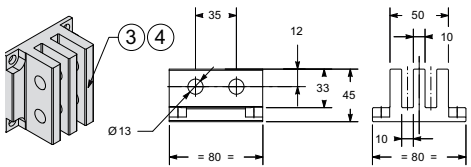

Key

- | | | |
|------------------------------|----------------------------------|--|
| 1 Horizontal terminals 3200A | 5 Tightening torque 3200A 20Nm | 12 Mobile part |
| 2 Vertical terminals 3200A | 6 Tightening torque 4000A 20Nm | 13 Fixed part |
| 3 Horizontal terminals 4000A | 7 Door position - Ref. page 7/19 | 14 Segregation (where envisaged) |
| 4 Vertical terminals 4000A | 8 Earthing device | 15 Distance from connected for testing to isolated |

Front terminals – F

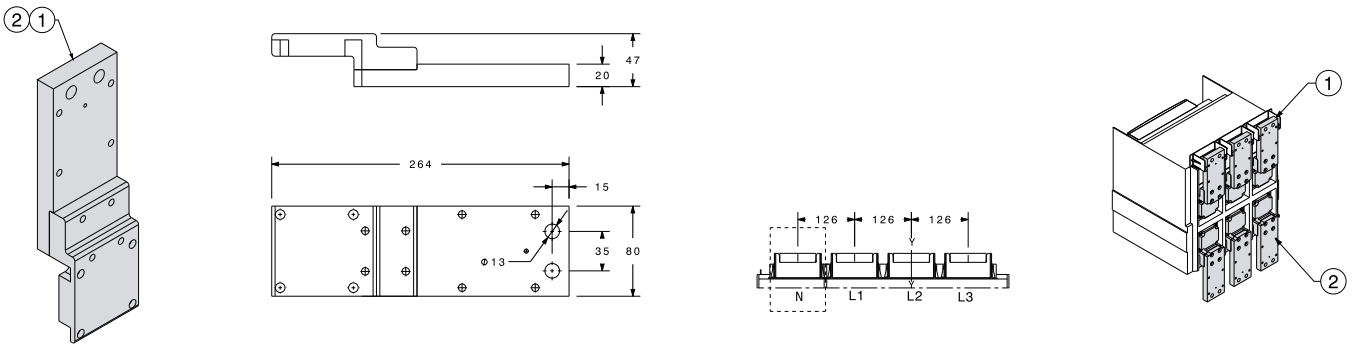
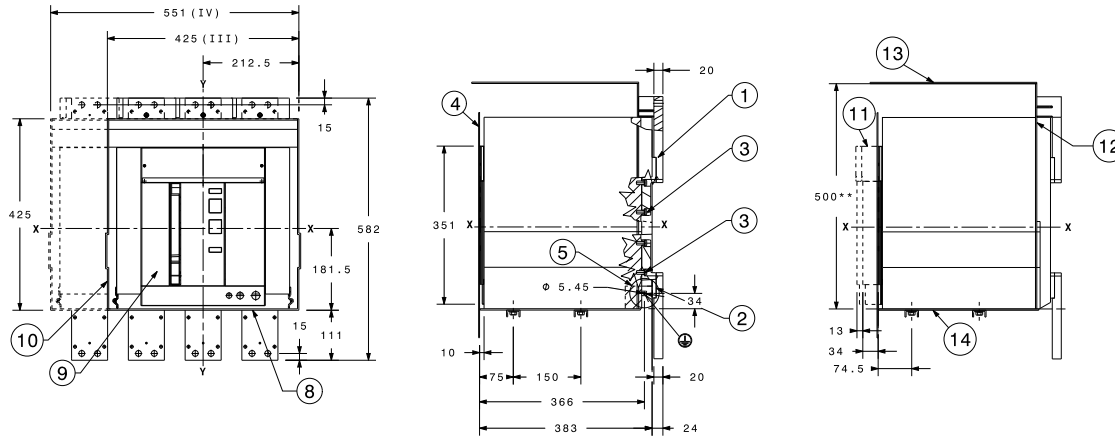

** for plastic enclosures

- Key**
- | | | |
|----------------------------------|--|---|
| 1 Upper front terminals | 8 External fixing point.
Recommended screws M10x25 high class | 11 Connected, test, disconnected distances |
| 2 Lower front terminals | 9 Moving part | 12 Insulating sheet or insulated metallic sheet |
| 3 Tightening torque 20Nm | 10 Fixed part | 13 Roof insulation or insulated metal |
| 4 Door position - Ref. page 7/19 | | 14 Fixing plate |
| 5 Earthing device | | |

Dimensions

Withdrawable circuit-breaker - E6.2

Horizontal rear terminals – HR

E6.2 H/V 4000-5000A

E6.2 H/V 6300A
E6.2 X 4000...6300A

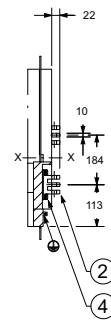
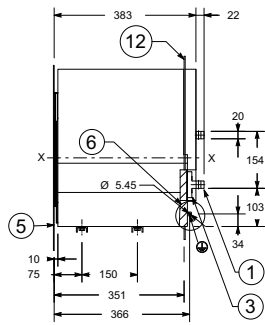
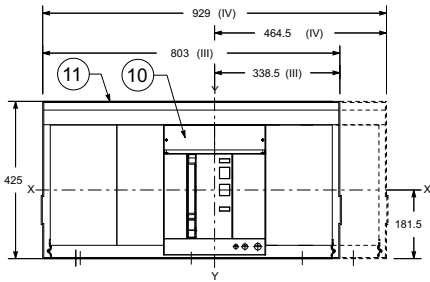

E6.2 H/V 4000-5000A

7

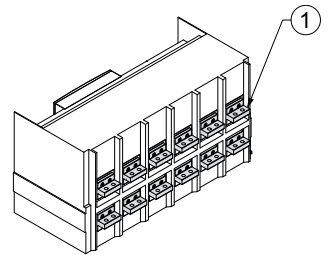
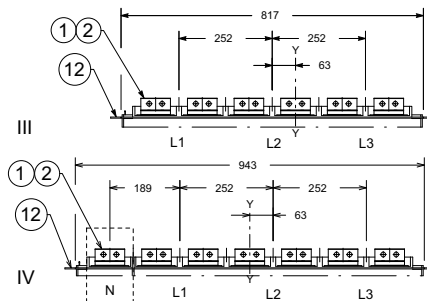
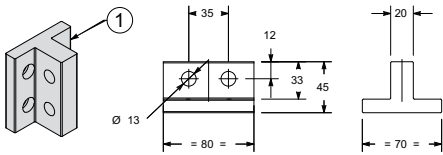

E6.2 H/V 6300A

E6.2 X 4000...6300A

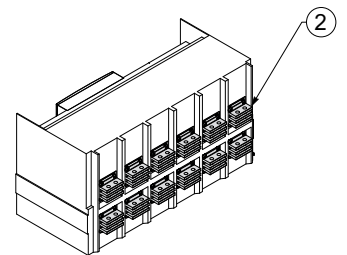
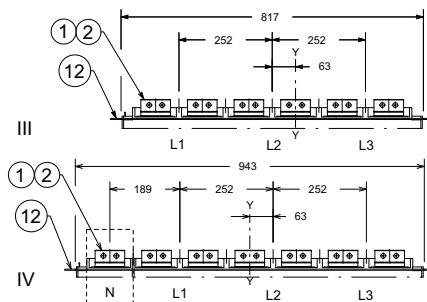
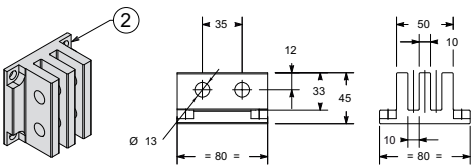

Key

- | | | |
|-------------------------------------|----------------------------------|----------------------------------|
| 1 Horizontal terminals 4000-5000A | 4 Tightening torque 6300A 20Nm | 10 Mobile part |
| 2 Horizontal terminals 6300A | 5 Door position - Ref. page 7/19 | 11 Fixed part |
| 3 Tightening torque 4000-5000A 20Nm | 6 Earthing device | 12 Segregation (where envisaged) |

Vertical rear terminals – VR

E6.2 H/V 4000-5000A

E6.2 H/V 6300A
E6.2 X 4000...6300A

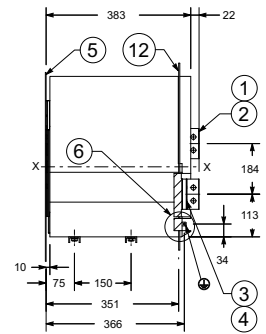
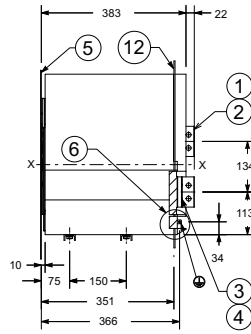
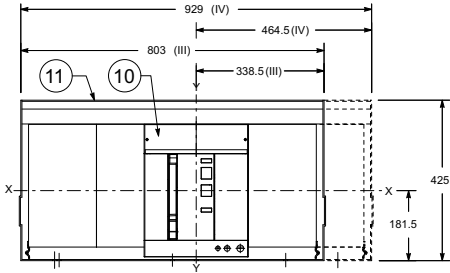

E6.2 H/V 4000-5000A

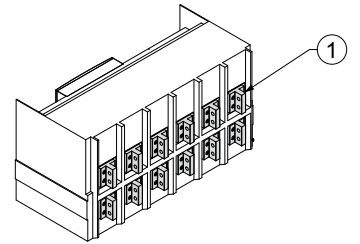
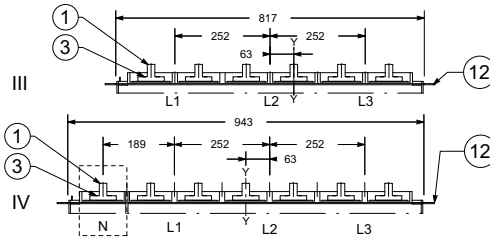
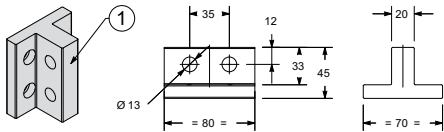

E6.2 H/V 6300A
E6.2 X 4000...6300A

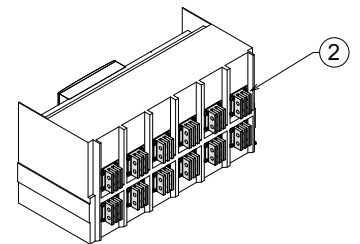
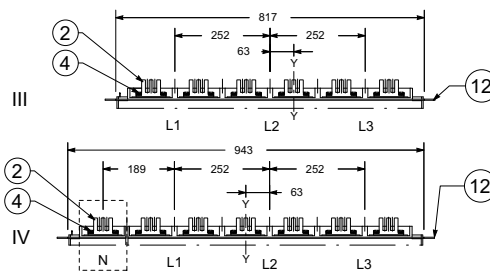
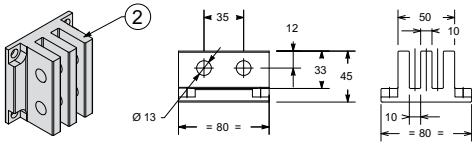

Key

- | | | |
|-------------------------------------|----------------------------------|----------------------------------|
| 1 Vertical terminals 4000-5000A | 4 Tightening torque 6300A 20Nm | 10 Mobile part |
| 2 Vertical terminals 6300A | 5 Door position - Ref. page 7/19 | 11 Fixed part |
| 3 Tightening torque 4000-5000A 20Nm | 6 Earthing device | 12 Segregation (where envisaged) |

Dimensions

Withdrawable circuit-breaker - E6.2

Rear orientable terminals - HR/VR full size

E6.2 H/V 5000A

E6.2 H/V 6300A
E6.2 X 5000...6300A

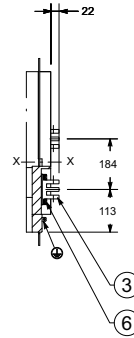
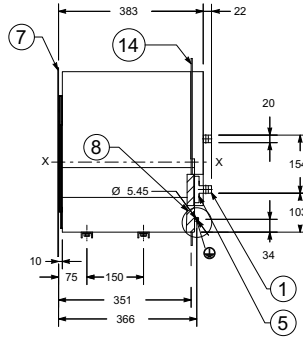
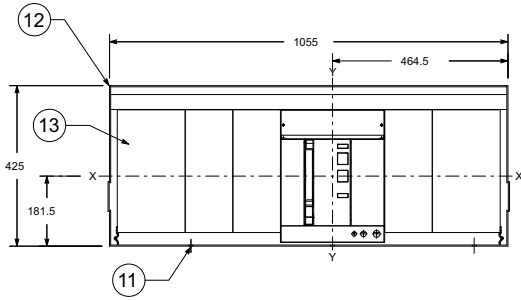

E6.2 H/V 4000-5000A

7

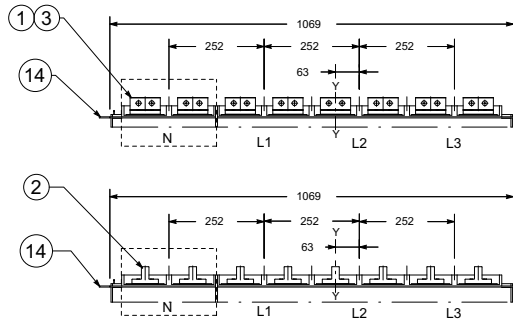
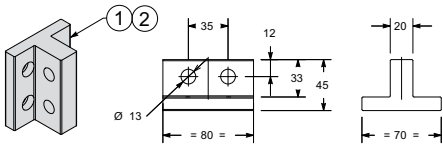

E6.2 H/V 6300A

E6.2 X 4000...6300A

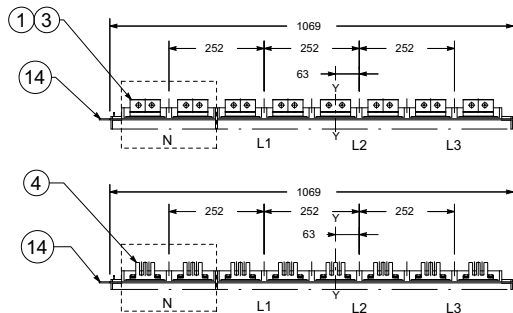
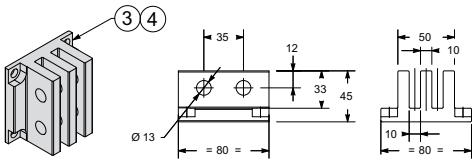

Key

- | | | |
|-----------------------------------|-------------------------------------|----------------------------------|
| 1 Horizontal terminals 4000-5000A | 5 Tightening torque 4000-5000A 20Nm | 12 Mobile part |
| 2 Vertical terminals 4000-5000A | 6 Tightening torque 6300A 20Nm | 13 Fixed part |
| 3 Horizontal terminals 6300A | 7 Door position - Ref. page 7/19 | 14 Segregation (where envisaged) |
| 4 Vertical terminals 6300A | 8 Earthing device | |

Front terminals – F

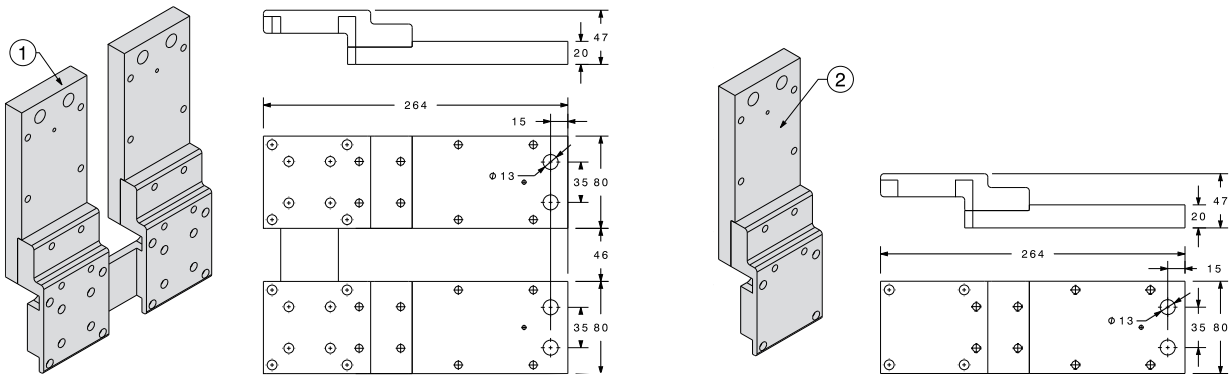
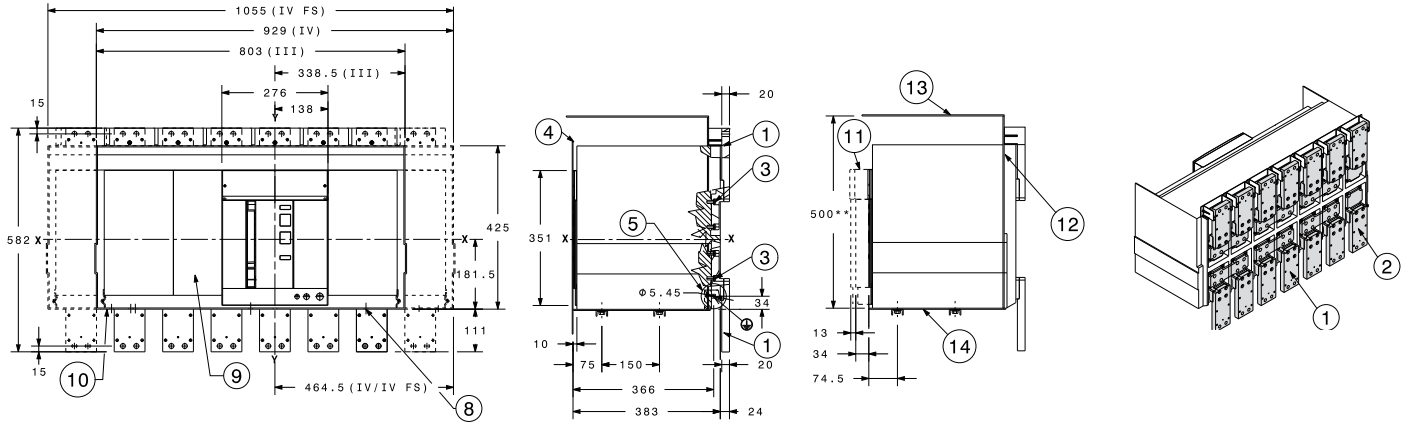

** for plastic enclosures

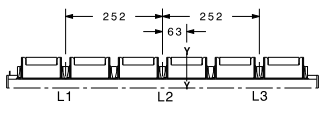

3-pole

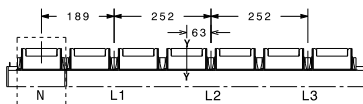

4-pole

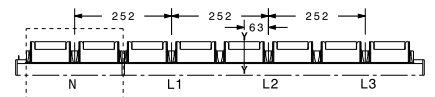

4-pole full size

- Key**
- 1 Upper front terminals
 - 2 Lower front terminals
 - 3 Tightening torque 20Nm
 - 4 Door position - Ref. page 7/19
 - 5 Earthing device
 - 8 External fixing point.
Recommened screws M10x25 high class
 - 9 Moving part
 - 10 Fixed part
 - 11 Connected, test, disconnected distances
 - 12 Insulating sheet or insulated metallic sheet
 - 13 Roof insulation or insulated metal
 - 14 Fixing plate

Electrical diagrams

Reading information

Circuit-breakers	8/2
ATS021 and ATS022	8/7
Power controller	8/8

Circuit-breakers	8/9
------------------	-----

Terminal box E1.2	8/10
-------------------	------

Terminal box E2.2 - E4.2 - E6.2	8/11
---------------------------------	------

Electrical accessories	8/12
------------------------	------

ATS021 and ATS022	8/37
-------------------	------

Electrical diagrams

Reading information – Circuit-breakers

Operating state shown

The diagram is shown in the following conditions:

- withdrawable version circuit-breaker, open and racked-in
- with de-energized circuits
- trip units not tripped
- motor operator with unloaded springs.

Versions

The diagram shows a withdrawable version circuit-breaker, but it is also valid for fixed version circuit-breakers.

Fixed version

The control circuits are included between the XV terminals (the X connector is not supplied).

Withdrawable version

The control circuits are included between the poles of the X connector (the XV terminal box is not supplied).

Description of figures

- 1) Supplementary open/closed auxiliary contacts of the circuit-breaker - AUX 6Q (6 Form C)
- 2) Ekip Signalling 4K
- 11) Trip signalling contact
- 12) Contact for signalling position of loaded springs - S33 M/2
- 13) Motor for loading closing springs- M
- 14) Remote reset - YR
- 20) Ekip Measuring/Measuring Pro with voltage socket inside the four pole circuit-breaker
- 21) Ekip Measuring/Measuring Pro with voltage sockets inside the three-pole circuit-breaker and connection for external neutral
- 22) Ekip Measuring Pro for residual voltage protection (for Ekip G only)
- 23) Ekip Measuring/Measuring Pro with external voltage socket
- 24) Rc residual current protection sensor input
- 25) Transformer star center sensor input
- 26) Zone selectivity
- 27) Current sensor input on external neutral (only for 3-pole circuit-breakers)
- 31) Direct auxiliary supply 24V DC and local bus - Ekip Supply
- 32) Auxiliary supply through module 110-240V AC/DC or 24-48V DC and local bus - Ekip Supply
- 41) Ekip signalling 2K-1
- 42) Ekip signalling 2K-2
- 43) Ekip signalling 2K-3
- 48) Ekip sinchrocheck
- 51) Ekip COM Modbus RS-485
- 52) Ekip COM Modbus TCP
- 53) Ekip COM Profibus
- 54) Ekip COM Profinet
- 55) Ekip COM DeviceNet
- 56) Ekip COM EtherNet IP
- 57) Ekip COM IEC61850
- 58) Ekip LINK
- 61) Ekip COM R Modbus RS-485 Redundant
- 62) Ekip COM R Modbus TCP Redundant
- 63) Ekip COM R Profibus Redundant
- 64) Ekip COM R Profinet Redundant

- 65) Ekip COM R DeviceNet Redundant
- 66) Ekip COM R EtherNet IP Redundant
- 71) Ready to close contact - RTC
- 72) Second opening coil - YO2
- 73) Undervoltage coil - YU
- 74) Undervoltage coil with external time-lag device - YU, D
- 75) First opening coil - YO
- 76) First opening coil with control from protection trip unit - YO, Ekip Com Actuator
- 77) First closing coil - YC
- 78) First closing coil with control from protection trip unit - YC, Ekip Com Actuator
- 79) Second closing coil - YC2
- 81) Open/closed auxiliary contacts of circuit-breaker - AUX 4Q (4 Form C)
- 91) External supplementary open/closed auxiliary contacts of circuit-breaker - AUX 15Q (15 Form C)
- 95) Auxiliary position contacts - AUP (E1.2)
- 96) Auxiliary position contacts - AUP (E2.2-E6.2)
- 97) Supplementary auxiliary position contacts - AUP (E2.2 - E6.2)
- 98) Circuit-breakers without auxiliary safety voltage
- 99) Circuit-breakers with auxiliary safety voltage in direct and alternating current
- 100) ATS021
- 101) ATS022
- 102) Third circuit-breaker controlling with ATS022
- 103) Ekip Signalling 10K
- 104) Ekip Multimeter
- 105) Application diagram for Ekip Touch, Hi-Touch, G Touch, G Hi-Touch with Power Controller function.

Electrical diagrams

Reading information – Circuit-breakers

Key

*	= See the note indicated by the letter
A1	= Applications located on the mobile part of the circuit-breaker
A3	= Applications located on the fixed part of the circuit-breaker
A4	= Indicative devices and connections for control and signalling, outside the circuit-breaker
BUS1	= Serial interface with external bus
D	= Electronic time-lag device of YU undervoltage coil, outside the circuit-breaker
F1	= Time-delayed trip fuse
GZi(DBi)	= Zone selectivity input for G protection or input in “reverse” direction for D protection
GZo(DBo)	= Zone selectivity output for G protection or output in “reverse” direction for D protection
I O1...32	= Programmable digital inputs of the EKIP protection trip unit
K51	= Electronic overcurrent protection trip unit of the types: EKIP DIP, EKIP TOUCH, EKIP LCD, EKIP HI-TOUCH , EKIP HI-LCD, EKIP G TOUCH, EKIP G LCD, EKIP G HI-TOUCH , EKIP G HI-LCD
K51/COM	= Communication module
K51/MEAS	= Measurement module
K51/SIGN	= Signalling module
K51/SUPPLY	= Optional auxiliary supply module (110-220VAC/DC and 24-48VDC)
K51/SYNC	= Synchronization module
K51/YC	= Closing control from the EKIP protection trip unit
K51/YO	= Opening control from the EKIP protection trip unit
M	= Motor for loading closing springs
O 01...32	= Programmable signalling contacts of the EKIP protection trip unit
O SC	= EKIP protection trip unit contact for synchronism control
Q	= Circuit-breaker
Q/1...Q/25	= Auxiliary contacts of circuit-breaker
Q/26...Q/27	= Auxiliary open/close contacts used internally by the trip unit
RC	= RC (residual current) protection sensor
RT1...RT3	= Temperature sensors
RTC EKIP	= Auxiliary ready to close contact of circuit-breaker, used internally by the trip unit
RTC	= Contact for signalling circuit-breaker is ready to close
S33M/1...2	= Limit contacts of spring loading motor
S43	= Switch for presetting remote/local control
S51	= Trip signalling contact
S75E/1...4	= Contacts for signalling circuit-breaker in racked-out position (provided only with withdrawable version)
S75I/1...5	= Contacts for signalling circuit-breaker in racked-in position (provided only with withdrawable version)
S75T/1...2	= Contact for signalling circuit-breaker in test position (provided only with withdrawable version)
SC	= Pushbutton or contact for closing the circuit-breaker
SO	= Pushbutton or contact for immediate opening of the circuit-breaker
SO1	= Pushbutton or contact for opening the circuit-breaker with time-delayed trip
SR	= Pushbutton or contact for electrical resetting of S51 trip contact
SZi(DFi)	= Input for zone selectivity for S protection or input in “direct” direction for S protection
SZo(DFo)	= Output for zone selectivity for S protection or output in “direct” direction for D protection
TI/L1	= Current transformer phase L1
TI/L2	= Current transformer phase L2
TI/L3	= Current transformer phase L3
TI/N	= Current transformer on neutral
TU1...TU2	= Insulation voltage transformer (outside circuit-breaker)
Uaux	= Auxiliary supply voltage
UI/L1	= Current sensor phase L1

UI/L2	= Current sensor phase L2
UI/L3	= Current sensor on phase L3
UI/N	= Current sensor on neutral
UI/O	= Single-pole current sensor
W2	= Serial interface with internal bus (local bus)
W9...W13	= RJ45 connector for communication modules
W9R.W11R	= RJ45 connector for redundant communication modules
X	= Delivery connector for auxiliary circuits for withdrawable version of circuit-breaker
XB1...XB7	= Connectors for circuit-breaker applications
XF	= Delivery terminal board for position contacts of withdrawable version of circuit-breaker
XK1...XK3	= Connectors for auxiliary circuits of the EKIP protection trip unit
XK7	= Connector for auxiliary circuits of communication module
XV	= Delivery terminal box for auxiliary circuits of fixed version circuit-breaker
YC	= Closing coil
YC2	= Second closing coil
YO	= Opening coil
YO1	= Opening coil for overcurrent
YO2	= Second opening coil
YR	= Coil for electrical resetting of trip contact S51
YU	= Undervoltage coil

Electrical diagrams

Reading information – Circuit-breakers

Notes

- A) Auxiliary supply for Ekip trip unit is mandatory (refer to diagram 1SDM00009R0001 figures 31 - 32- 33 - 34).
- B) When there are mixed auxiliary contacts Q1 and Q2 are 400V, while Q3 and Q4 are 24V. Then Q5, Q6, Q7 are 400V, while Q8, Q9, Q10 are 24V.
- C) Always supplied with Ekip Com module.
- D) Always supplied with motor for loading closing springs in Fig. 13.
- E) Obligatory voltage transformer in the case of external sockets. Obligatory external sockets for systems with rated voltage greater than 690V.
- F) The connections between the RC residual current protection sensor and the poles of the X connector (or XV) of the circuit-breaker must be made with 4-pole shielded cable with conductors interwoven in pairs (type BELDEN 9696 paired or equivalent), of a length no greater than 10 m. The shield should be earthed on circuit-breaker side.
- G) With all electronic protection trip units equipped with display interface with LSIG protections, protection against an earth fault is available (Gext) by means of current sensor positioned on the star centre of the MV/LV transformer.
The connection between terminals 1 and 2 of the UI/O current transformer and Ge+ and Ge- poles of the X connector (or XV) must be made with shielded and stranded 2-pole cable (type BELDEN 9841 or equivalent) of length no greater than 15 m.
- H) The connection between the terminal box and external neutral sensor must be made with the 2m cable provided. For three pole circuit breakers, the Ne+ and Ne- poles of the X connector (or XV) must be short-circuited if no sensor is present on the external neutral conductor.
- I) Obligatory in the case of the presence of any Ekip module.
- J) Only for E2.2, E4.2 and E6.2 withdrawable version circuit-breakers as an alternative to Fig. 31-32-34.
- K) Only for E2.2, E4.2 and E6.2 withdrawable version circuit-breakers as an alternative to Fig. 31-32-33.
- K) Only for E2.2, E4.2 and E6.2 withdrawable version circuit-breakers as an alternative to Fig. 31-32-33.
- L) In the presence of Fig. 32, for E2.2, E4.2 and E6.2 circuit-breakers up to three applications between Fig. 41...58 taken only once can be supplied, instead for E1.2 circuit-breakers, up to two applications between Fig. 41...58 taken only once can be supplied. The Ekip Com module selected can be duplicated if required, by choosing between Fig. 61...66.
- M) In the presence of Fig. 33, for E2.2, E4.2 and E6.2 circuit-breakers, up to two applications between Fig. 41...58 taken only once can be supplied. The Ekip Com module selected can be duplicated if required, by choosing between Fig. 61...66.
- N) In the presence of Fig. 34, for E2.2, E4.2 and E6.2 circuit-breakers, a single application between Fig. 41...58 can be supplied.
- O) In the presence of several Ekip Com modules with withdrawable version circuit-breakers, the contact S75I/5 should be connected only once to a single module.
- P) The auxiliary voltage Uaux. enables activation of all the functions of the EKIP electronic protection trip units. Since an earth insulated Uaux was requested, it is necessary to use “galvanically separated convertors” which comply with the standards IEC 60950 (UL 1950) or equivalent, which guarantee a common mode current or leakage current (refer to IEC 478/1, CEI 22/3) no greater than 3.5mA, IEC 60364-41 and CEI 64-8.
- Q) Regarding local bus the maximum cable length is 15m.
- R) Suggested RJ45 cable: CAT6 STP.

Electrical diagrams

Reading information – ATS021 and ATS022

Operating state shown

The diagram is shown in the following conditions:

- circuit-breakers open and racked-in #
- with de-energized circuits
- trip units not tripped *
- unloaded closing springs.

Key

A	=	ATS021 and ATS022 devices for automatic switching of two circuit-breakers
CB1-N	=	Normal supply line circuit-breaker
CB2-E	=	Emergency supply line circuit-breaker
K1	=	Auxiliary contactor type NF22E for voltage presence of normal power supply
K2	=	Auxiliary contactor type NF22E for voltage presence of emergency power supply
KC1-KC2	=	Auxiliary contactors type AL__-30 for the closing of the circuit-breakers
KO1-KO2	=	Auxiliary contactors type AL__-30 for the opening of the circuit-breakers
M	=	Motor for loading the closing springs
Q/1	=	Auxiliary contact of the circuit-breaker
Q60	=	Thermal relay for isolating and protecting the auxiliary circuits of safety auxiliary voltage
Q61/1-2	=	Thermal relays for isolating and protecting the auxiliary circuits of the lines
S11	=	Contact for enabling automatic switching of the ATS021 device
S11...S15	=	Signalling contacts for the inputs of the ATS022 device
S1-S2	=	Contacts controlled by the cam of the motor operator
S3	=	Changeover contact for electrical signalling of local/remote selector state
S33M/1	=	Limit contacts of spring loading motor
S51	=	Contact for electrical signalling of circuit-breaker open due to tripping of overcurrent trip unit
S75I/1	=	Contact for signalling circuit-breaker racked-in #
BUS 1	=	Serial interface with control system (MODBUS EIA RS485 interface) available with the device ATS022
X	=	Connector for auxiliary circuits of withdrawable version circuit-breakers
XF	=	Delivery terminal box for the position contacts of the circuit-breaker
XV	=	Delivery terminal box for the auxiliary circuits of the fixed version circuit-breakers
YC	=	Shunt closing release
YO	=	Shunt opening release

- # This diagram shows the withdrawable version circuit-breakers, but it is also valid for the fixed version circuit-breakers. In this case, it is not necessary to connect the S75I/1 contacts on the X31:1 input of the ATS021 device otherwise it is necessary to connect the X32:5 and X32:6 terminals with the terminal X32:9 of the ATS022 device.
- * This diagram shows circuit-breakers with overcurrent release but it is also valid for circuit-breakers without release (switch-disconnectors). If the S51 contact is not present, the S51 contacts on the X31:1 input of the ATS021 device should not be considered, while it is necessary to connect the X32:7 and X32:8 terminals with the X32:9 terminal of the ATS022 device.

Electrical diagrams

Reading information – Power Controller

Operating state shown

The diagram is shown in the following conditions:

- circuit-breaker, open and racked-in #
- with de-energized circuits
- trip units not tripped *
- motor operator with unloaded springs.

Key

A13	=	EKIP SIGNALLING 10K unit
A17	=	MOE actuator unit for stored energy operating mechanism for the Tmax XT circuit-breaker
A21	=	EtherNet Switch device
FI	=	Time-delayed trip fuse
I 01 ... 12	=	Programmable digital inputs of the EKIP protection trip unit
J ..	=	Connectors for auxiliary circuits of the Tmax XT circuit-breaker in the withdrawable version
K51	=	Electronic overcurrent protection trip unit type EKIP for EMAX 2 circuit-breaker type
K51/COM	=	Communication module for the EKIP trip unit
K51/SIGN	=	Signalling module for EKIP trip unit
K51/SUPPLY	=	Optional auxiliary supply module for the EKIP trip unit
K51/YC	=	Closing control from the EKIP protection trip unit
K51/YO	=	Opening control from the EKIP protection trip unit
M	=	Motor for loading closing springs for EMAX 2 circuit-breaker type
M	=	Motor for opening the circuit-breaker and for loading closing springs for TMAX XT circuit-breaker type
O 01 ... 12	=	Programmable signalling contacts of the EKIP protection trip unit
Q/1	=	Auxiliary contacts of circuit-breaker
Q1	=	Emax 2 circuit-breaker equipped with EKIP POWER CONTROLLER
Q2	=	Emax 2 circuit-breaker
Q3	=	Tmax XT circuit-breaker equipped with MOE actuator unit
Q4	=	Emax 2 MS switch-disconnector
R1	=	Resistor
S33M/1	=	Limit contacts of spring loading motor
S51	=	Trip signalling contact
S751/5	=	Contacts for signalling Emax 2 circuit-breaker in racked-in position (provided only for withdrawable version)
W13	=	RJ45 connector for communication modules
X	=	Delivery connector for auxiliary circuits for withdrawable version of Emax 2 circuit-breaker
XV	=	Delivery terminal box for auxiliary circuits of fixed version circuit-breaker
YC	=	Closing coil
YO	=	Opening coil

Electrical diagrams

Circuit-breakers (IEC60617 standards)

3-pole or 4-pole circuit-breaker

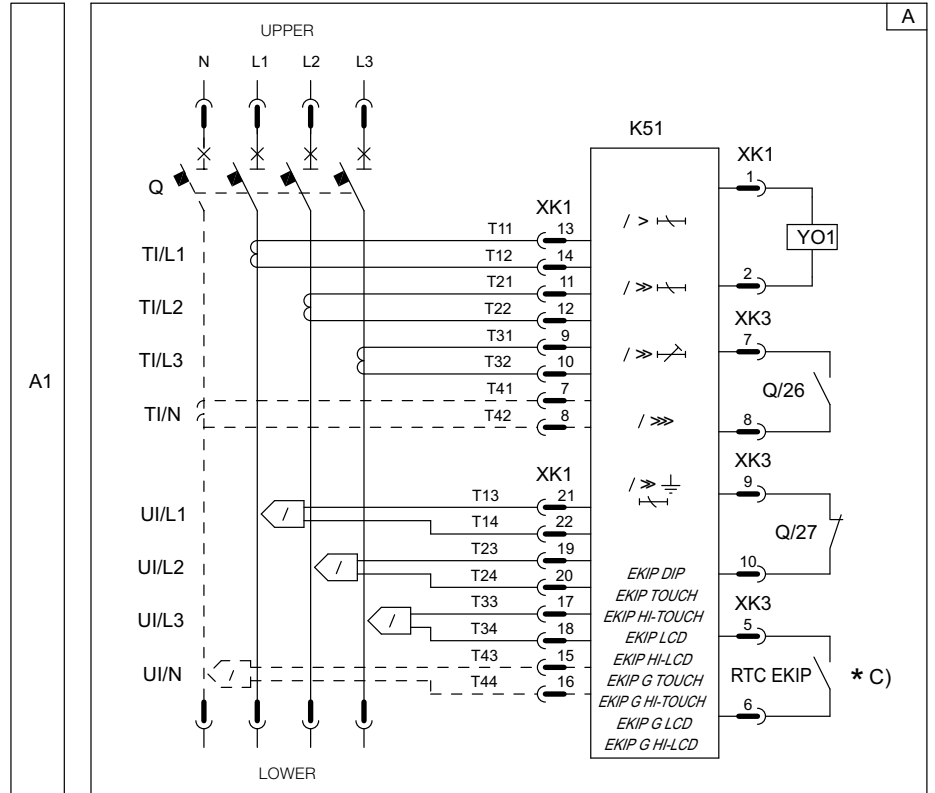

8

3-pole or 4-pole switch-disconnector

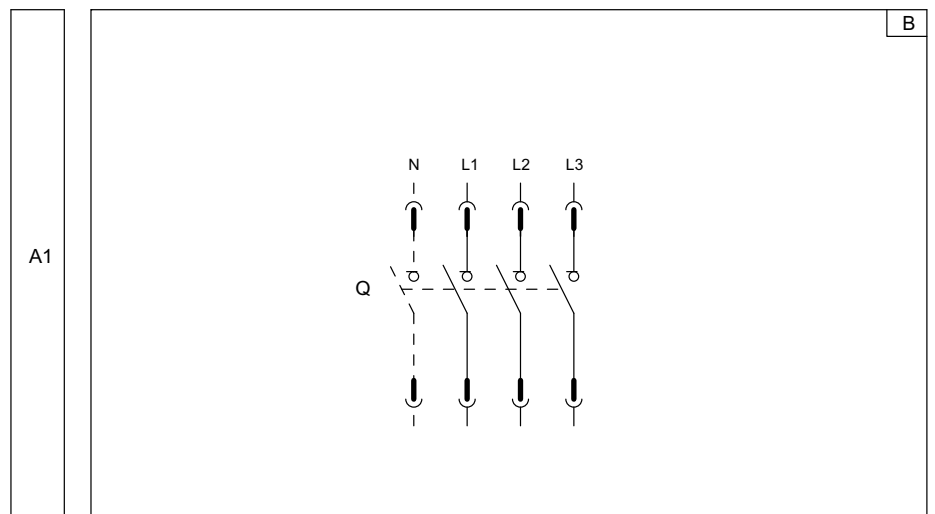

1SDC20062F001

Electrical diagrams

Terminal box E2.2 - E4.2 - E6.2

Diagram figure number

n

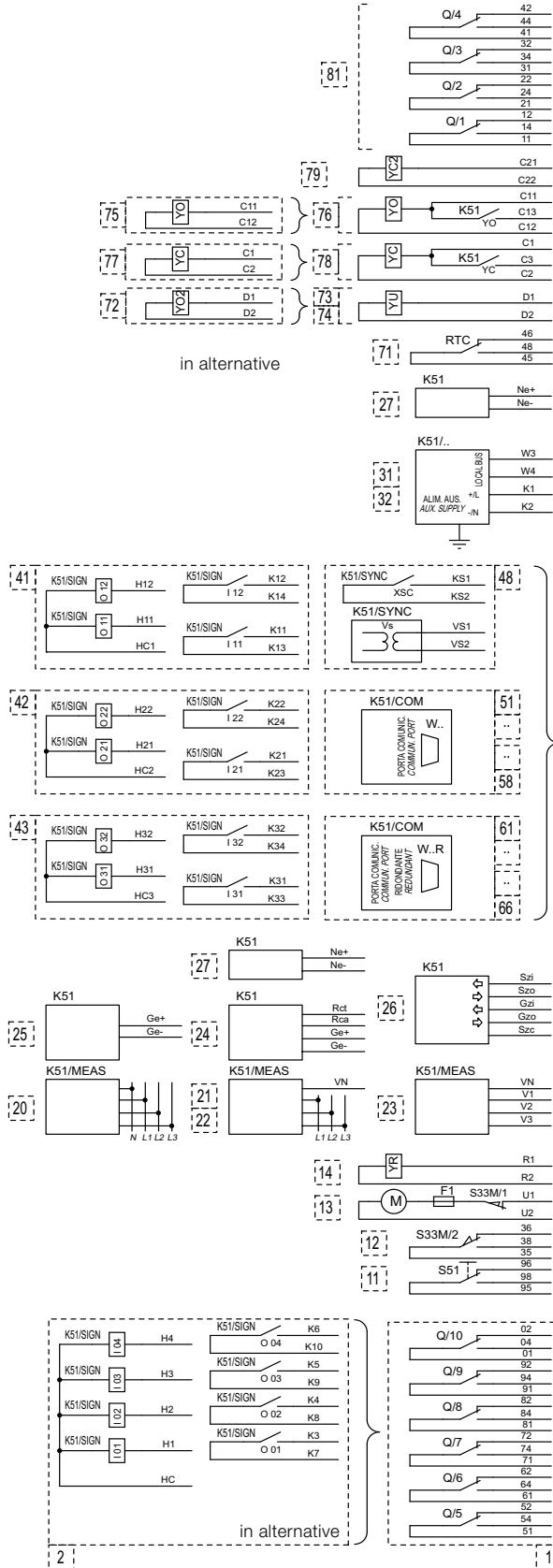

EKIP Supply				Module				Module				Module												
Ne-	Ne+	Rca	TU	W3	W4	K1	K2	Szi	Szo	Gzi	Gzo	V3	V2	V1	R1	R2	U1	U2	M	YR	S33	S51	Q5..Q10	Q1..Q4
I/O				I/O				I/O				I/O												
																							Open/closed auxiliary contacts of the circuit-breaker (first set)	81
																							Second closing coil	79
																							First shunt trip	75 76
																							First closing coil	77 78
																							Second shunt trip or undervoltage coil	73 74
																							Ready to close contact	71
																							Current sensor input on external neutral	27
																							Auxiliary supply and local bus	31 32
																							Signalling modules	41 42 43
																							and/or Ekip Synchrocheck	48
																							and/or communication modules	51 .. 58
																							and/or redundant communication modules	61 .. 66
																							Zone selectivity	26
																							Transformer star centre sensor input	25
																							RC residual current protection sensor input	24
																							Ekip Measuring voltage sockets	20 21 22 23
																							Remote reset	14
																							Motor	13
																							Contact for signalling position of loaded springs	12
																							Trip signalling contact	11
																							Ekip signalling 4K	2
																							Supplementary auxiliary contacts of circuit-breaker	1

Electrical diagrams

Electrical accessories

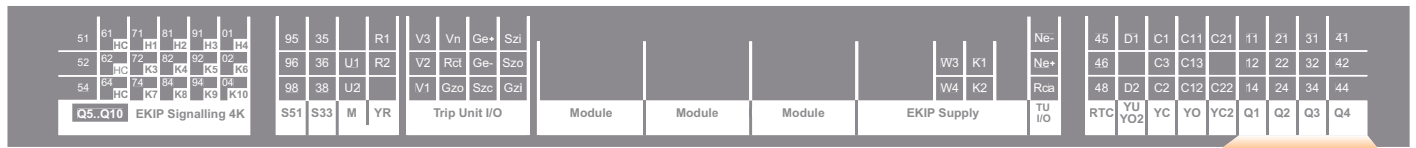

11	21	31	41
12	22	32	42
14	24	34	44
Q1	Q2	Q3	Q4

81) Open/closed auxiliary contacts of circuit-breaker - AUX 4Q (4 Form C)

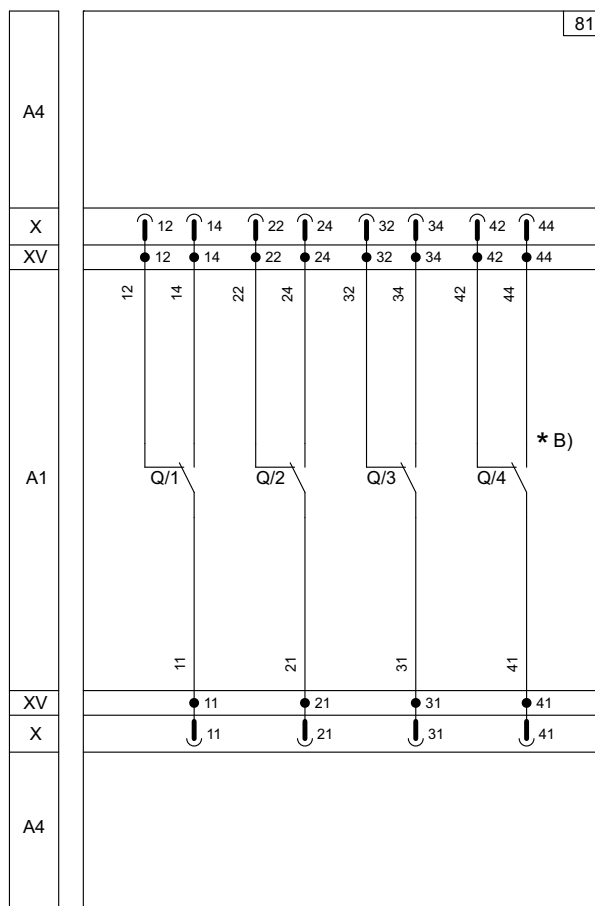

51	61	71	81	91	01	95	35	R1	V3	Vn	Ge+	Szi	Ne-	45	D1	C1	C11	C21	11	21	31	41			
52	62	72	82	92	02	96	36	U1	R2	V2	Rct	Ge-	Szo	Ne+	46		C3	C13		12	22	32	42		
54	64	74	84	94	04	98	38	U2		V1	Gzo	Szc	Gzi	Rca	48	D2	C2	C12	C22	14	24	34	44		
Q5..Q10 Ekip Signalling 4K						S51	S33	M	YR	Trip Unit I/O			W3	K1	Ne*	RTC	YU	YC	YO	YC2	Q1	Q2	Q3	Q4	
						Module			Module			Module			Ekip Supply			TU I/O							

45	D1	C1	C11	C21
46		C3	C13	
48	D2	C2	C12	C22
RTC	YU	YC	YO	YC2

- 77) First closing coil - YC
- 78) First closing coil with control from protection trip unit - YC, Ekip Com Actuator
- 79) Second closing coil - YC2

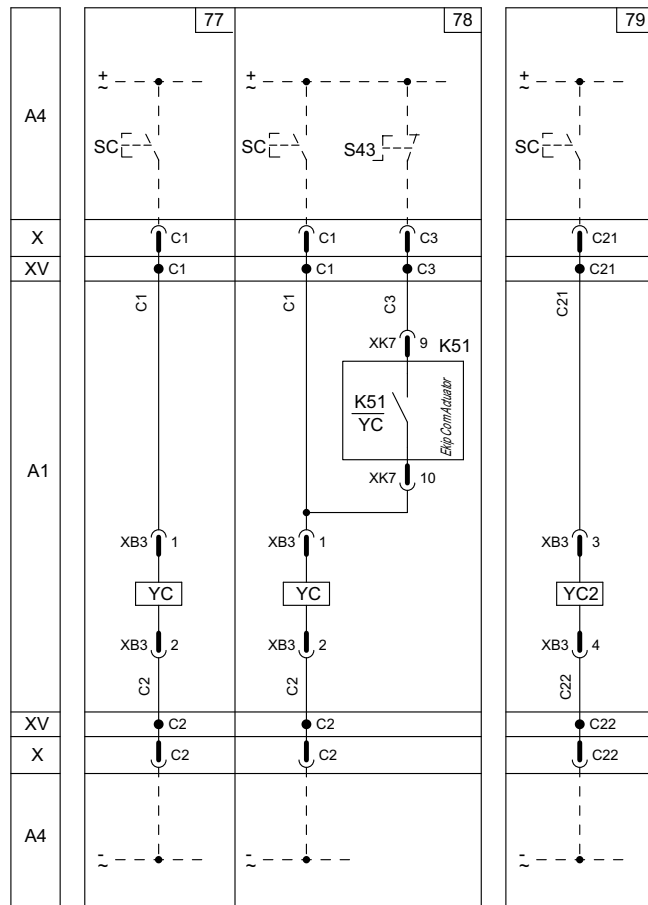

77- 78 as an alternative to each other
 79 valid only for E2.2 - E4.2 - E6.2

Electrical diagrams

Electrical accessories

51	61	71	81	91	01	95	35	R1	V3	Vn	Ge+	Szi	Ne-	45	D1	C1	C11	C21	11	21	31	41				
52	62	72	82	92	02	96	36	U1	R2	V2	Rct	Ge-	Szo	Ne+	46		C3	C13		12	22	32	42			
54	64	74	84	94	04	98	38	U2		V1	Gzo	Szc	Gzi	Rca	48	D2	C2	C12	C22	14	24	34	44			
Q5..Q10 EKIP Signalling 4K						S51	S33	M	YR	Trip Unit I/O			Module	Module	Module	EKIP Supply	TU I/O	RTC	YU YO2	YC	YO	YC2	Q1	Q2	Q3	Q4

45	D1	C1	C11	C21
46		C3	C13	
48	D2	C2	C12	C22
RTC	YU YO2	YC	YO	YC2

75) First opening coil - YO

76) First opening coil with control from protection trip unit - YO, Ekip Com Actuator

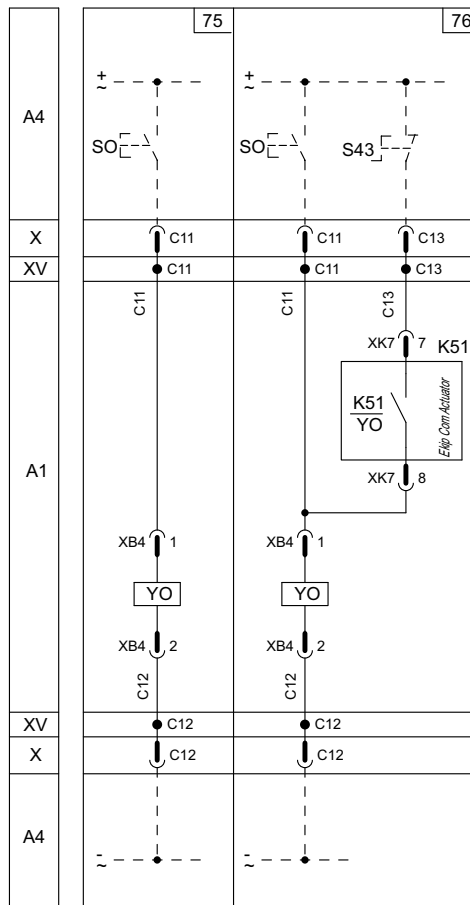

1SDC200628F001

75-76 as an alternative to each other

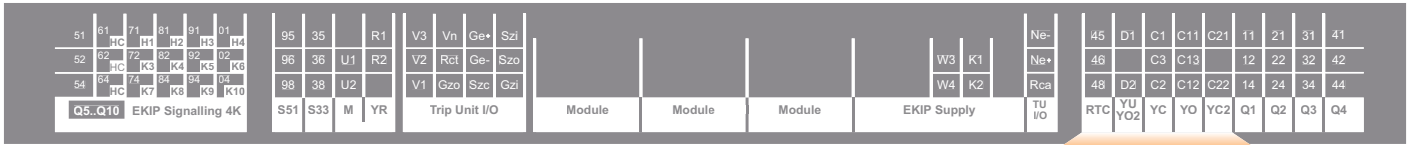

- 71) Ready to close signalling contact - RTC
- 72) Second opening coil - YO2
- 73) Undervoltage coil - YU
- 74) Undervoltage coil with external time-lag device - YU, D

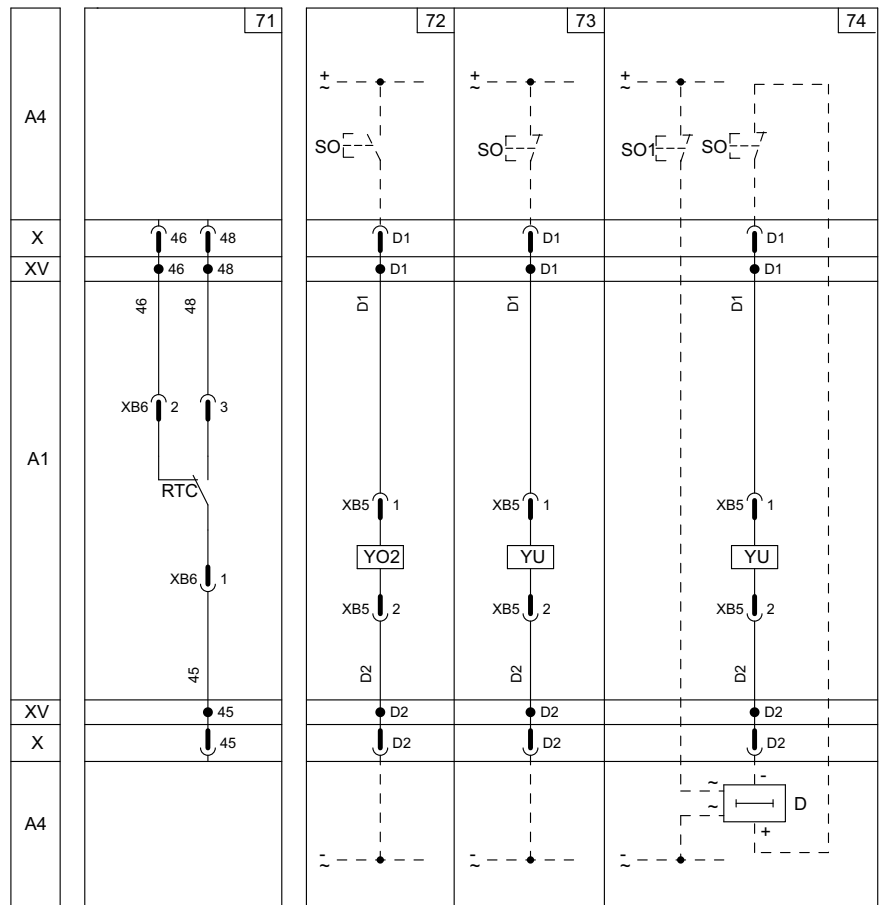

72-73 or 74 as an alternative to each other

Electrical diagrams

Electrical accessories

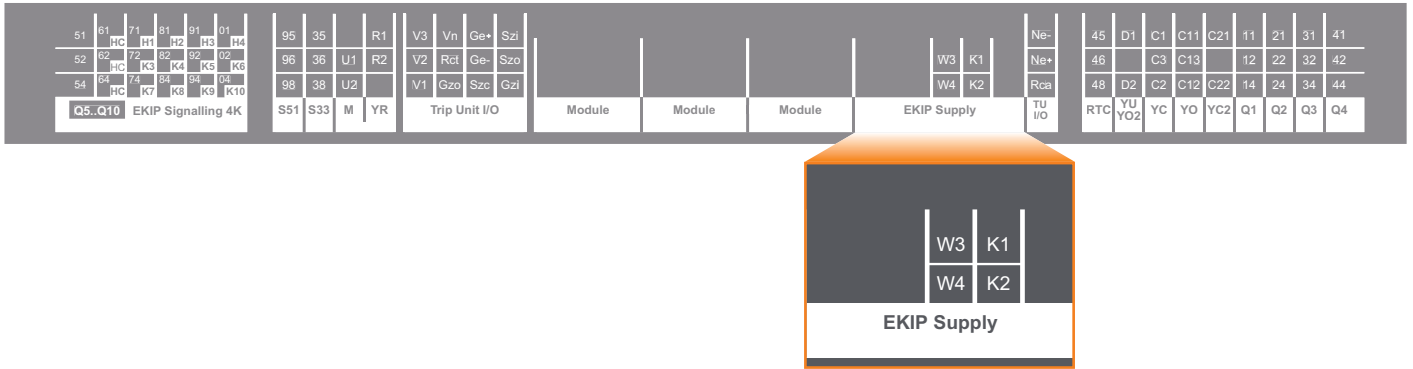

32) Auxiliary supply through module 110-240V AC/DC or 24-48V DC and local bus - Ekip Supply

8

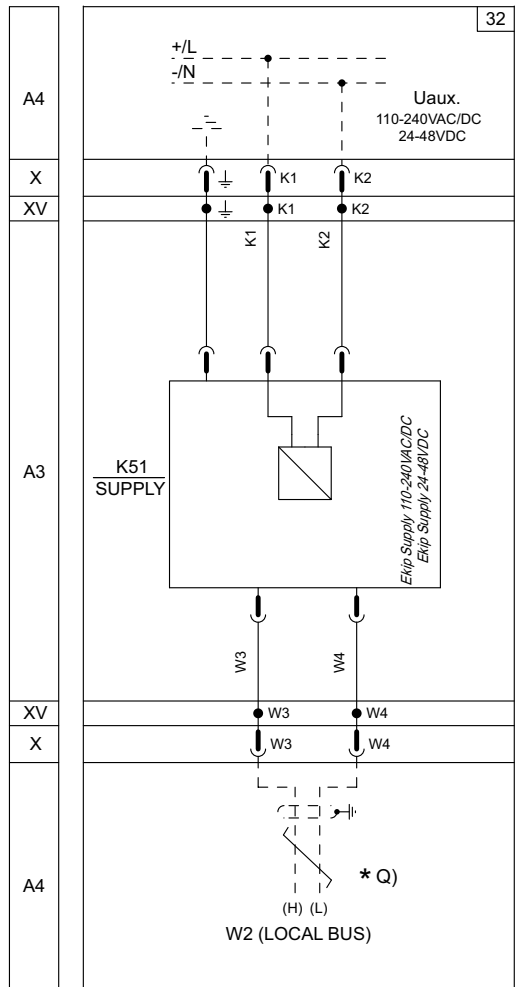

* 1)

As an alternative to figures 31-33

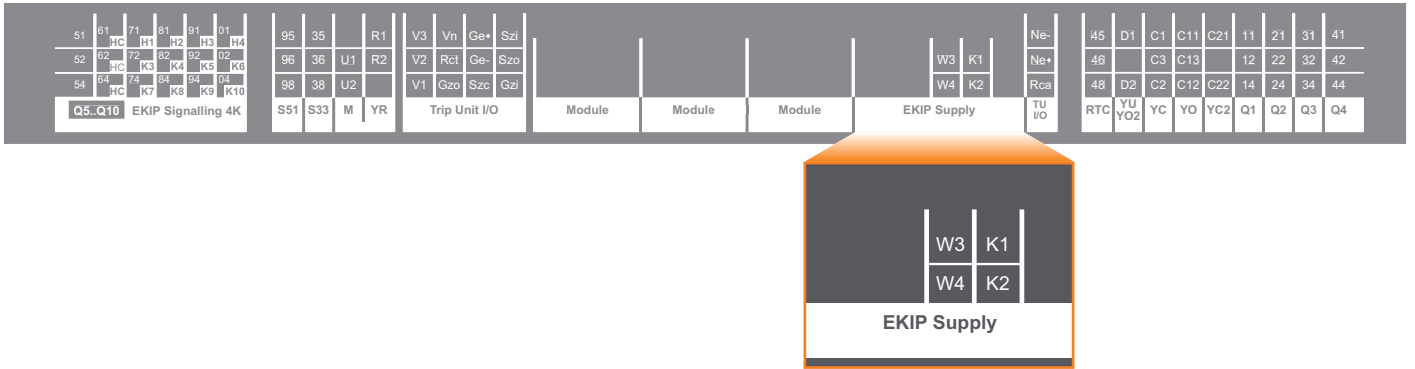

31) Direct auxiliary supply 24V DC and local bus - Ekip Supply

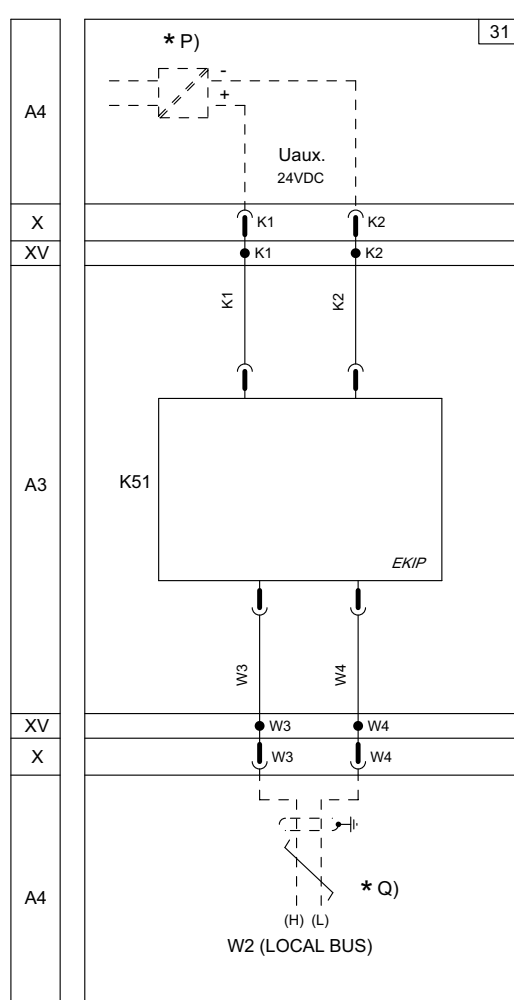

As an alternative to figures 32-33

Electrical diagrams

Electrical accessories

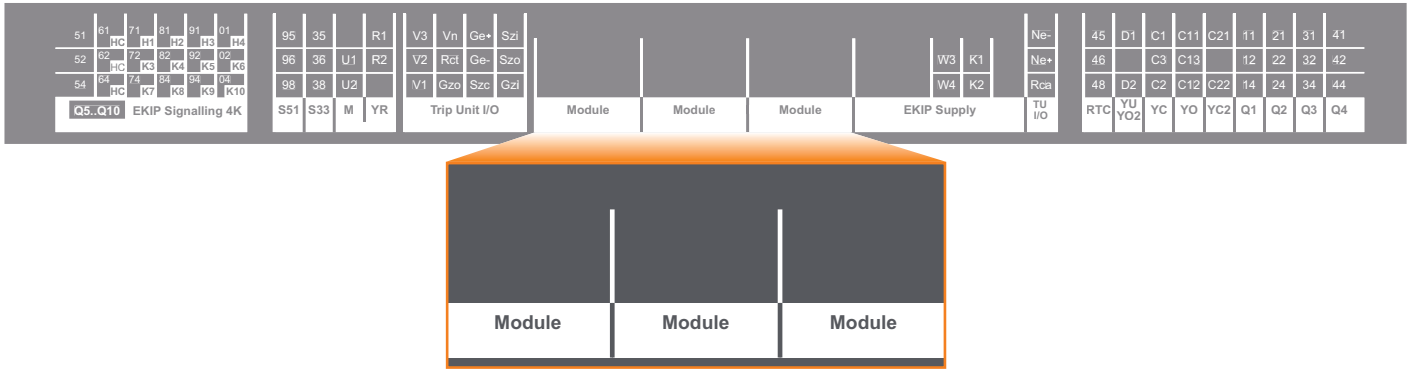

- 41) Ekip signalling 2K-1
- 42) Ekip signalling 2K-2

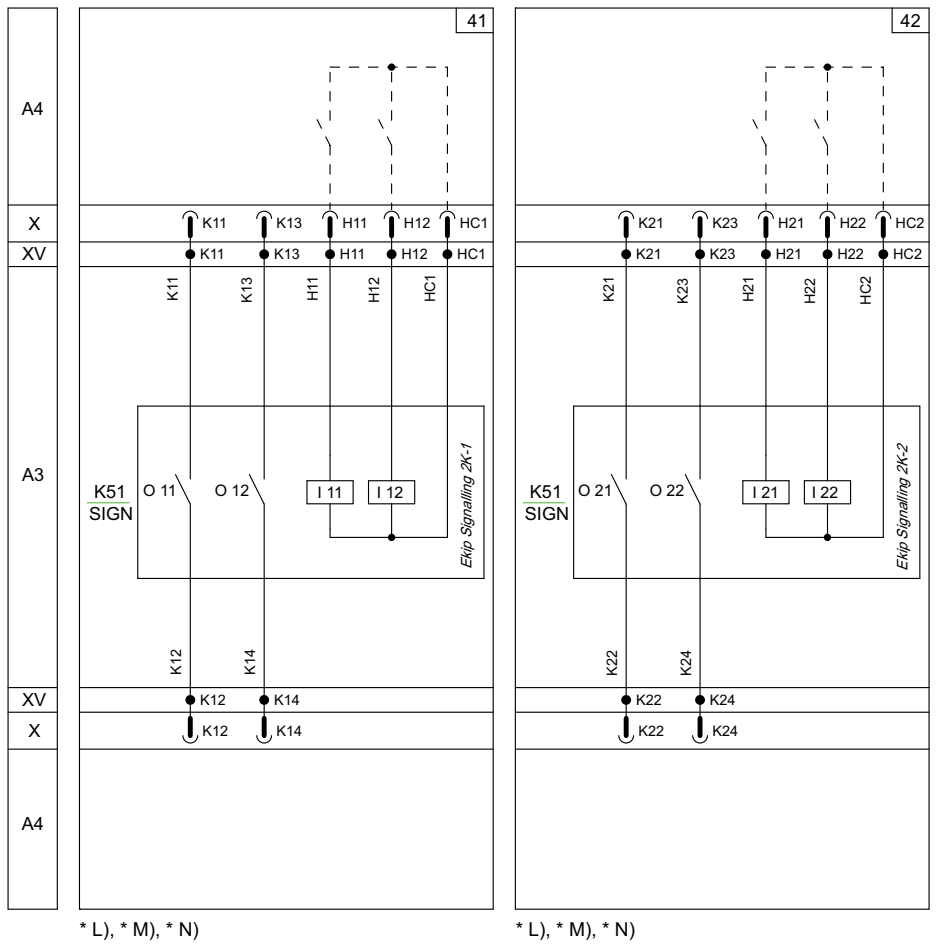

1SDC200023D0203

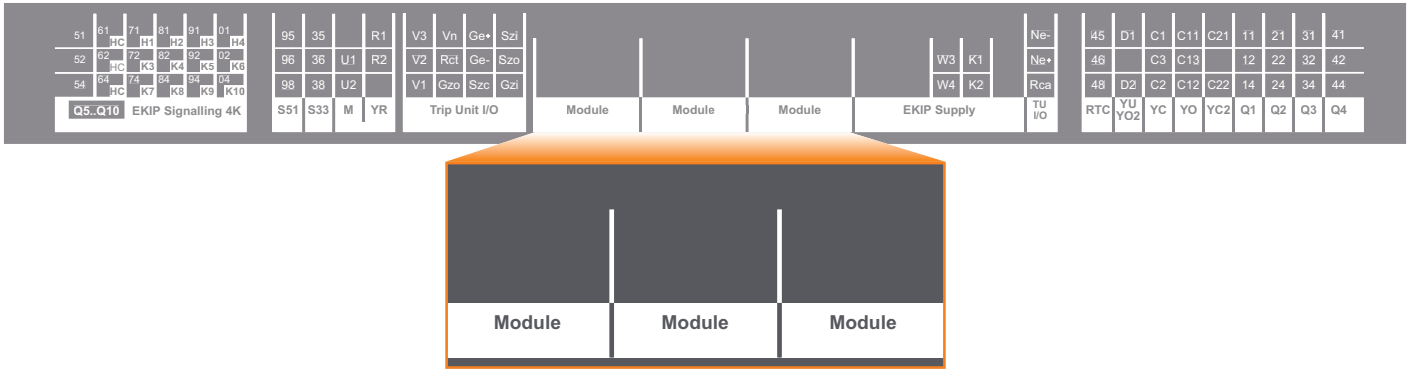

- 43) Ekip signalling 2K-3
- 48) Ekip Synchrocheck

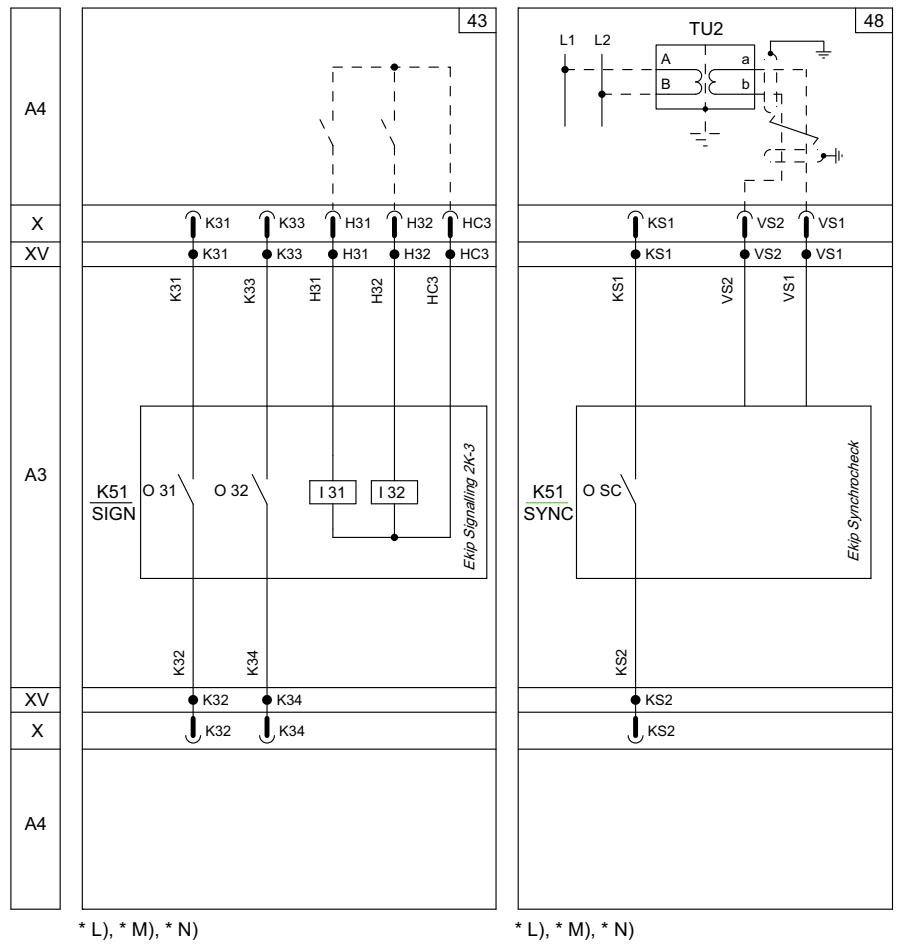

Electrical diagrams

Electrical accessories

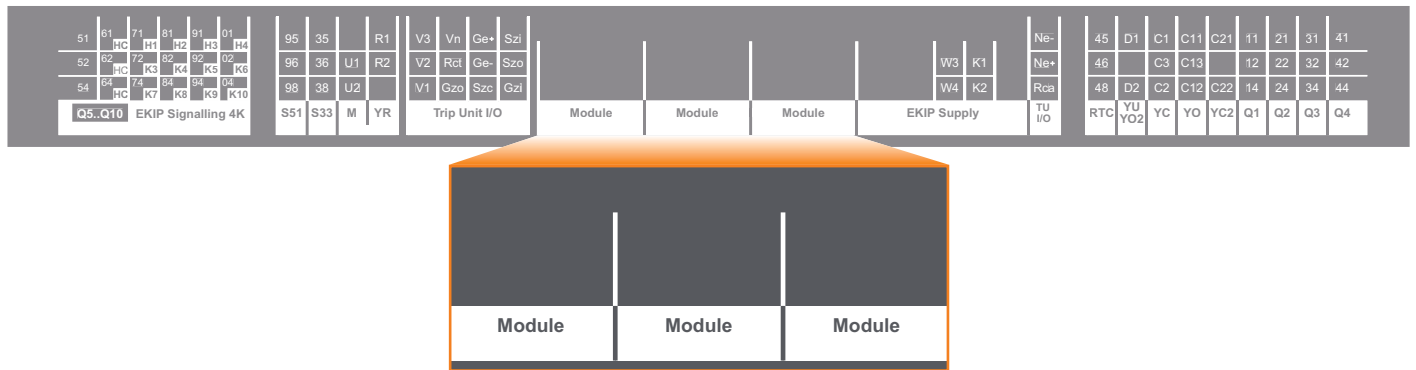

- 51) Ekip COM Modbus RS-485
- 52) Ekip COM Modbus TCP
- 53) Ekip COM Profibus

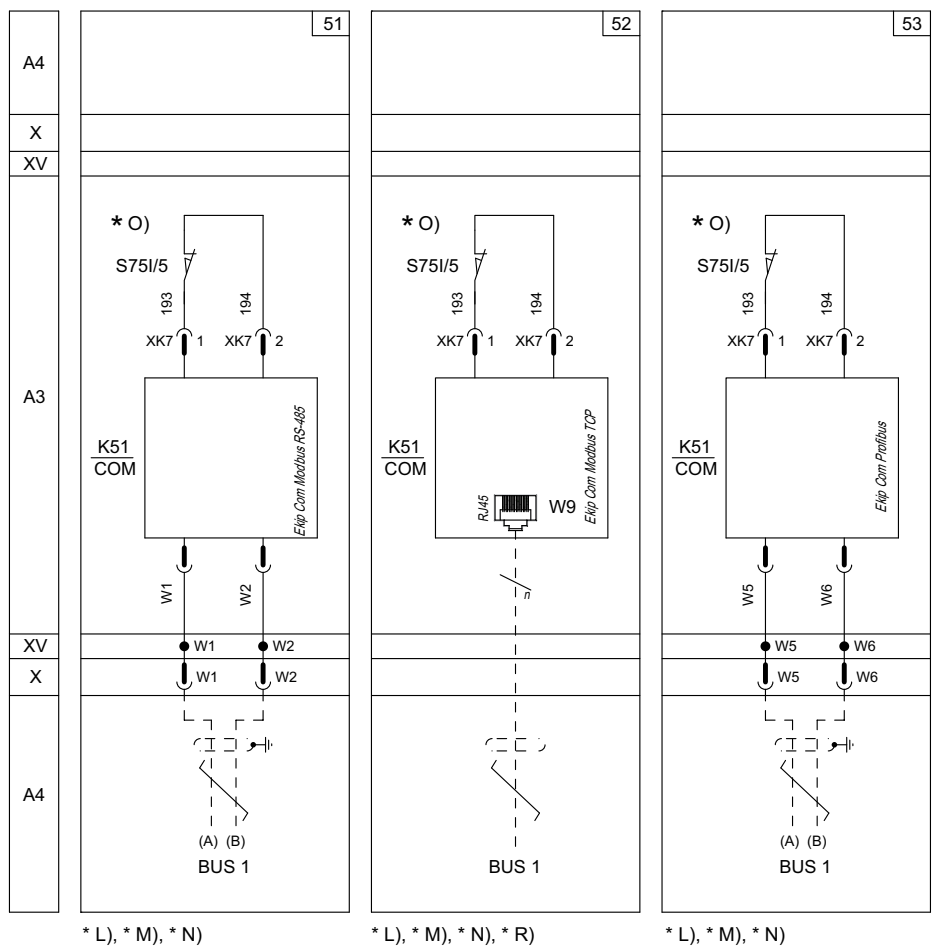

1SD20023D0203

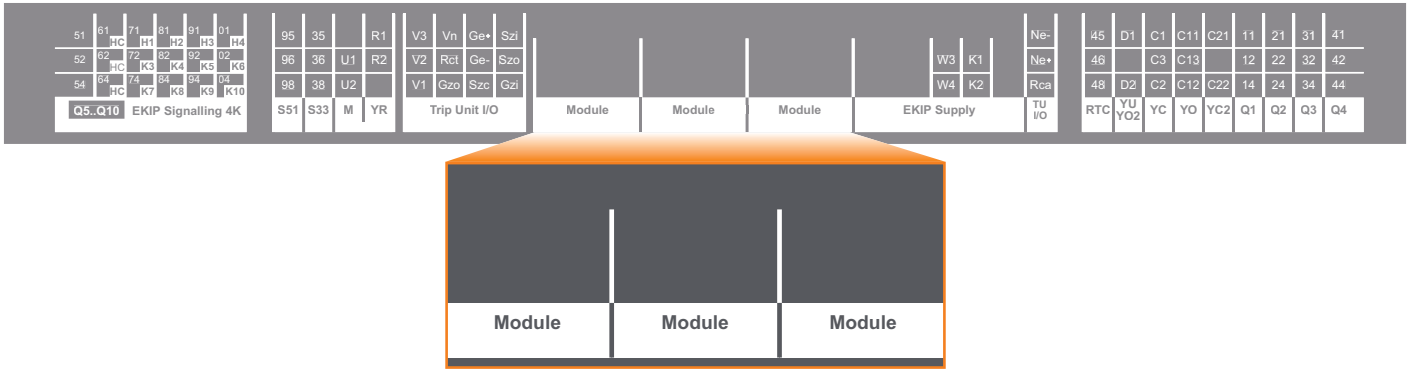

- 54) Ekip COM Profinet
- 55) Ekip COM DeviceNet
- 56) Ekip COM EtherNet IP

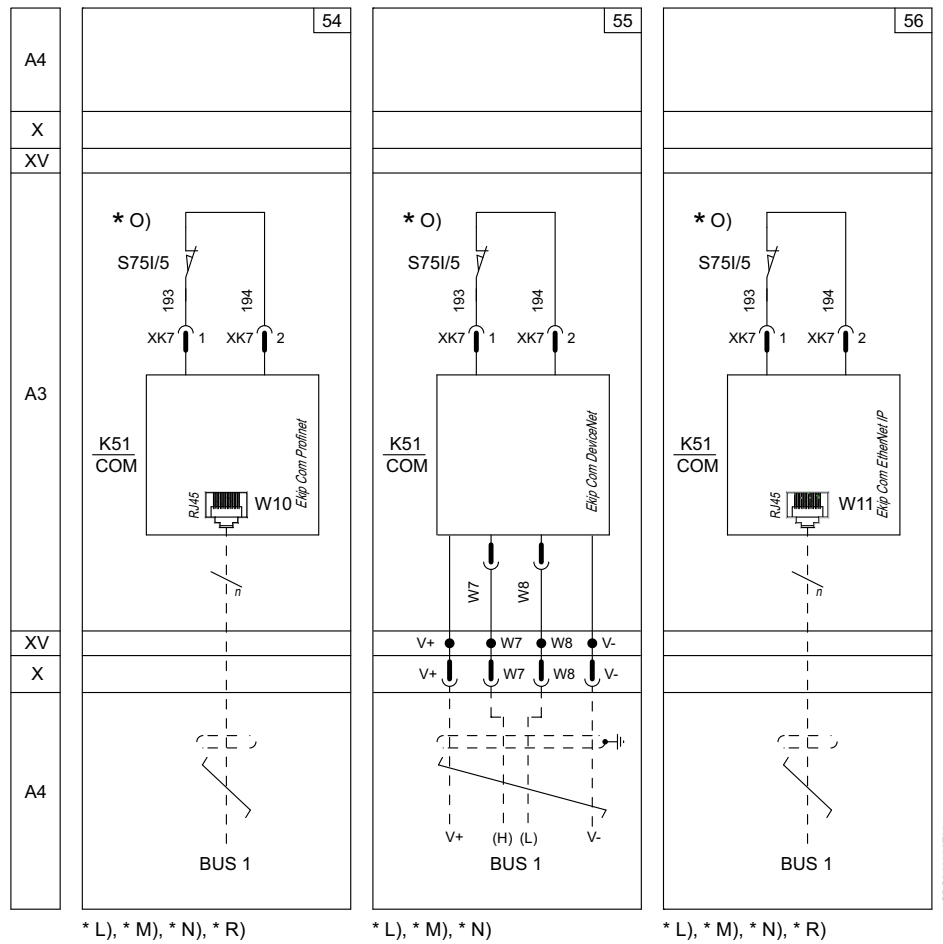

Electrical diagrams

Electrical accessories

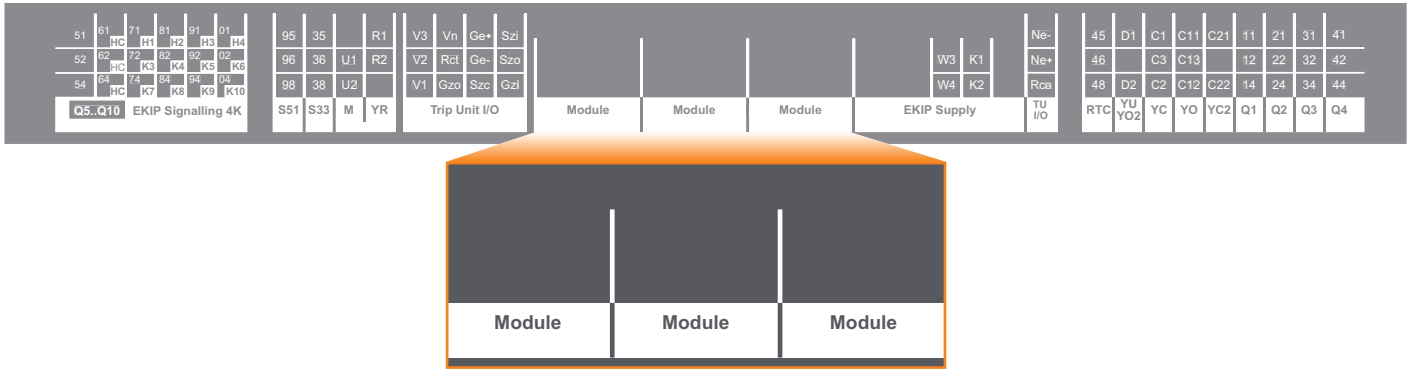

- 57) Ekip COM IEC61850
- 58) Ekip LINK

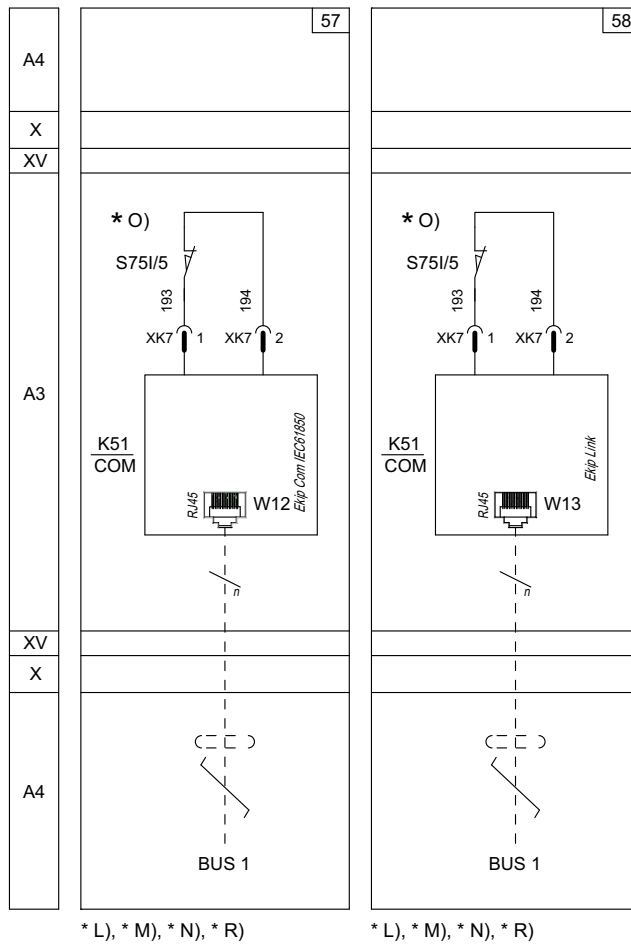

1SDC200637F001

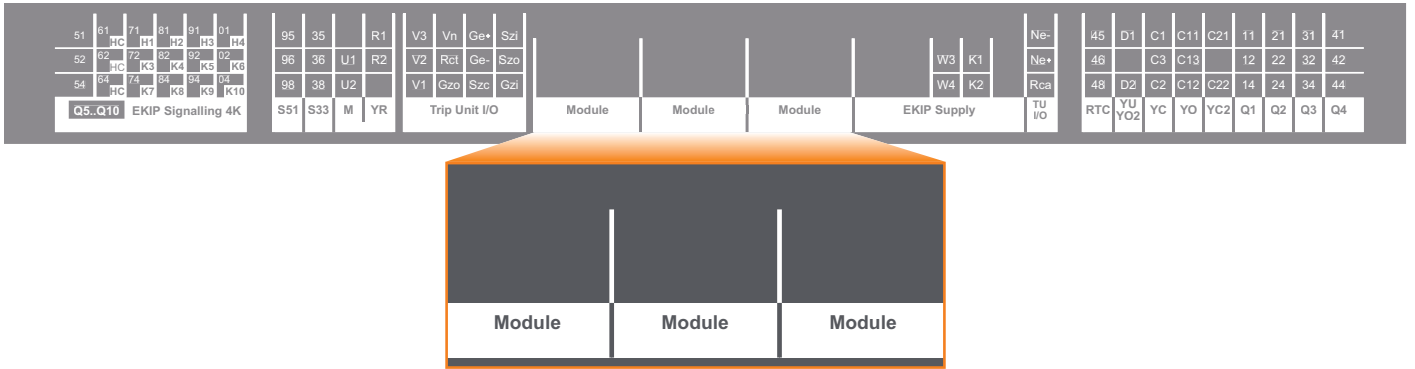

- 61) Ekip COM R Modbus RS-485 Redundant
- 62) Ekip COM R Modbus TCP Redundant
- 63) Ekip COM R Profibus Redundant

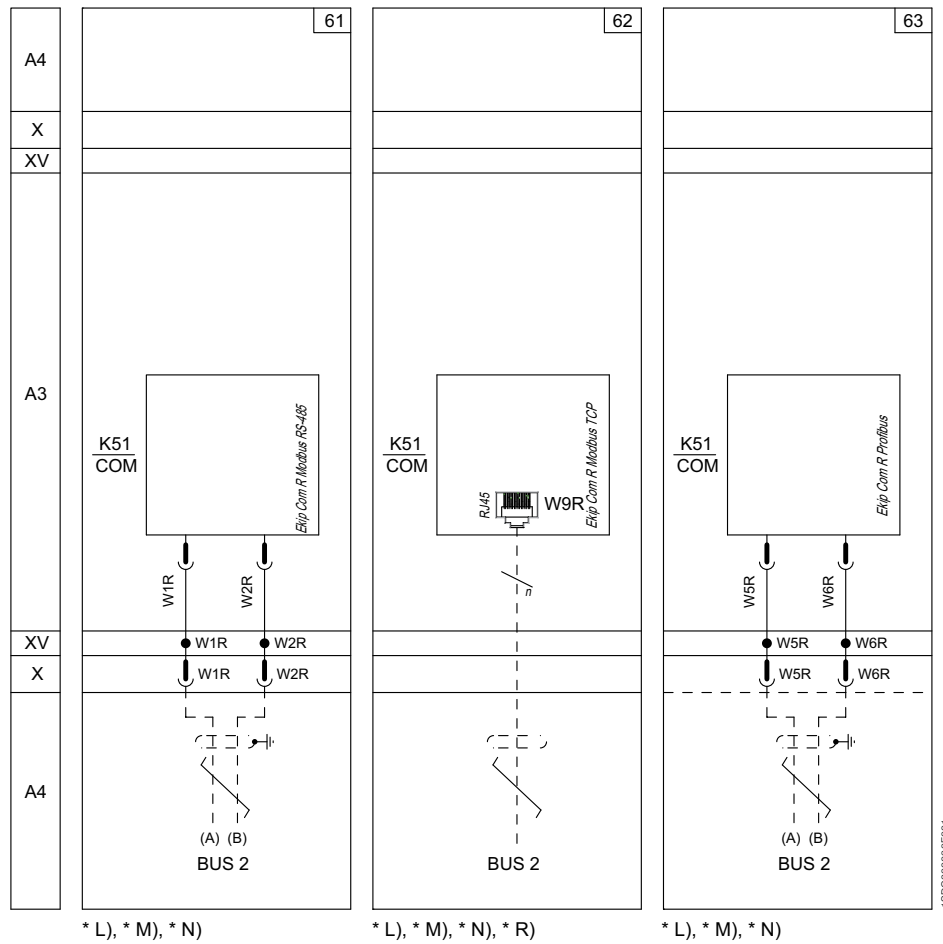

Electrical diagrams

Electrical accessories

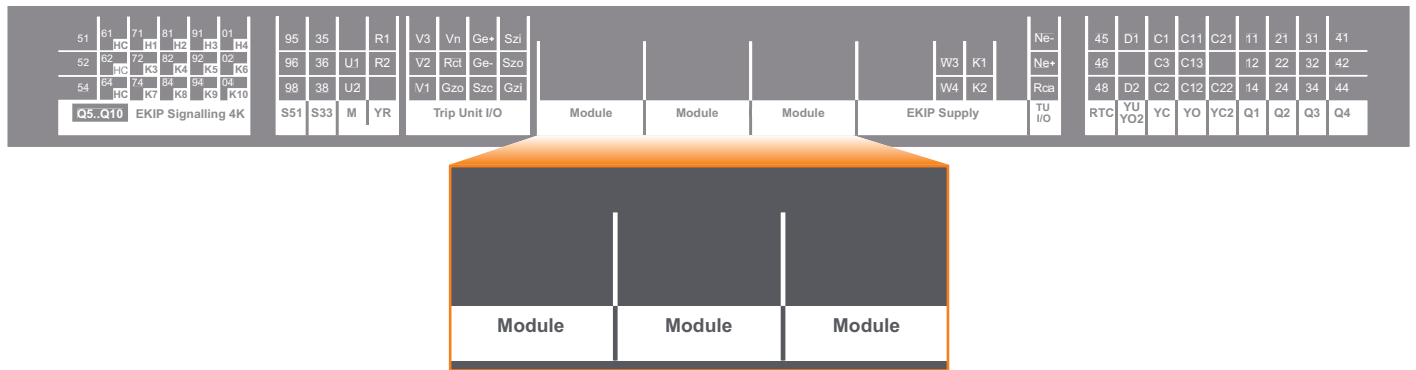

- 64) Ekip COM R ProfiNet Redundant
- 65) Ekip COM R DeviceNet Redundant
- 66) Ekip COM R EtherNet/IP Redundant

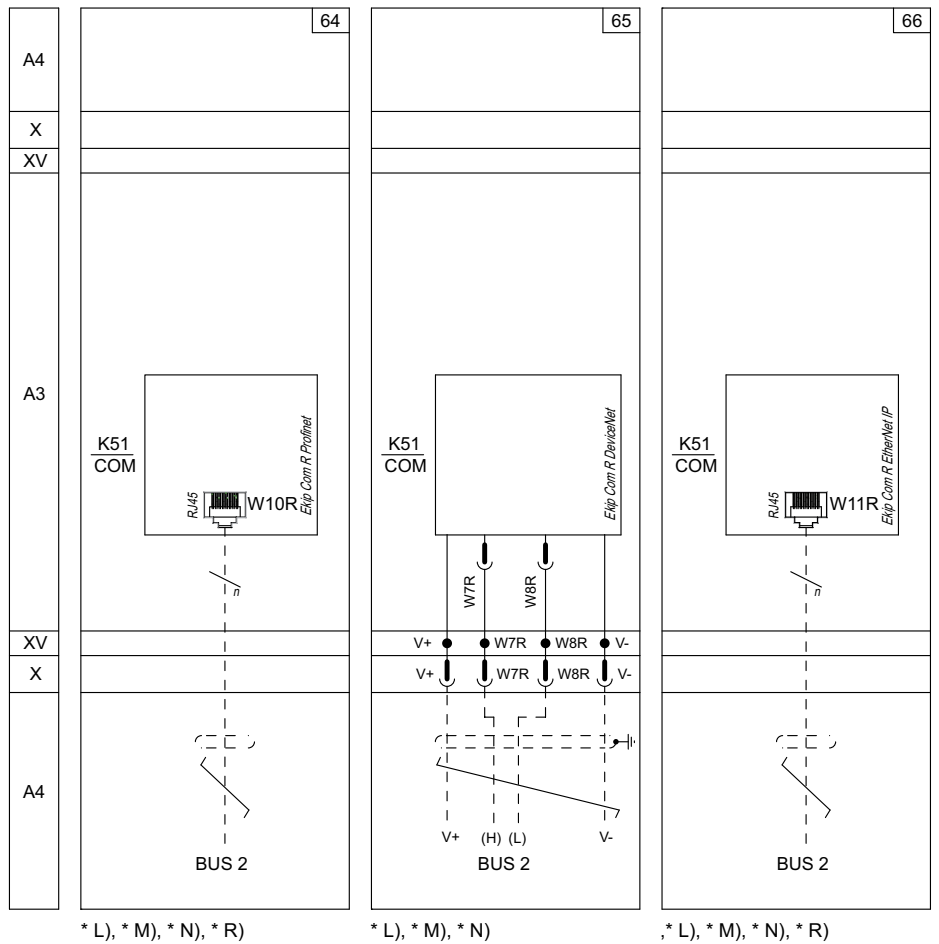

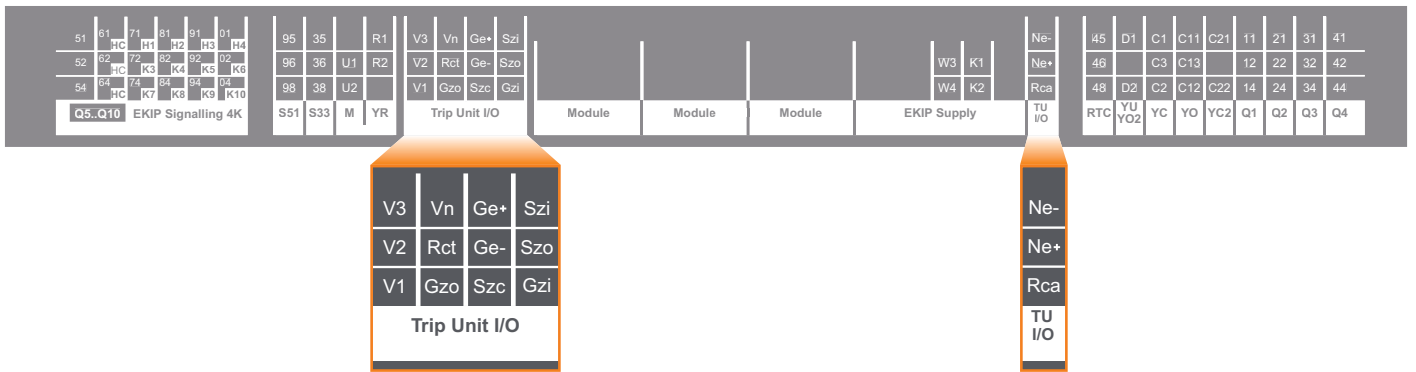

- 25) Transformer star center sensor input (homopolar toroid for the earthing conductor of main power supply)
- 27) Current sensor input on external neutral (only for 3-pole circuit-breakers)

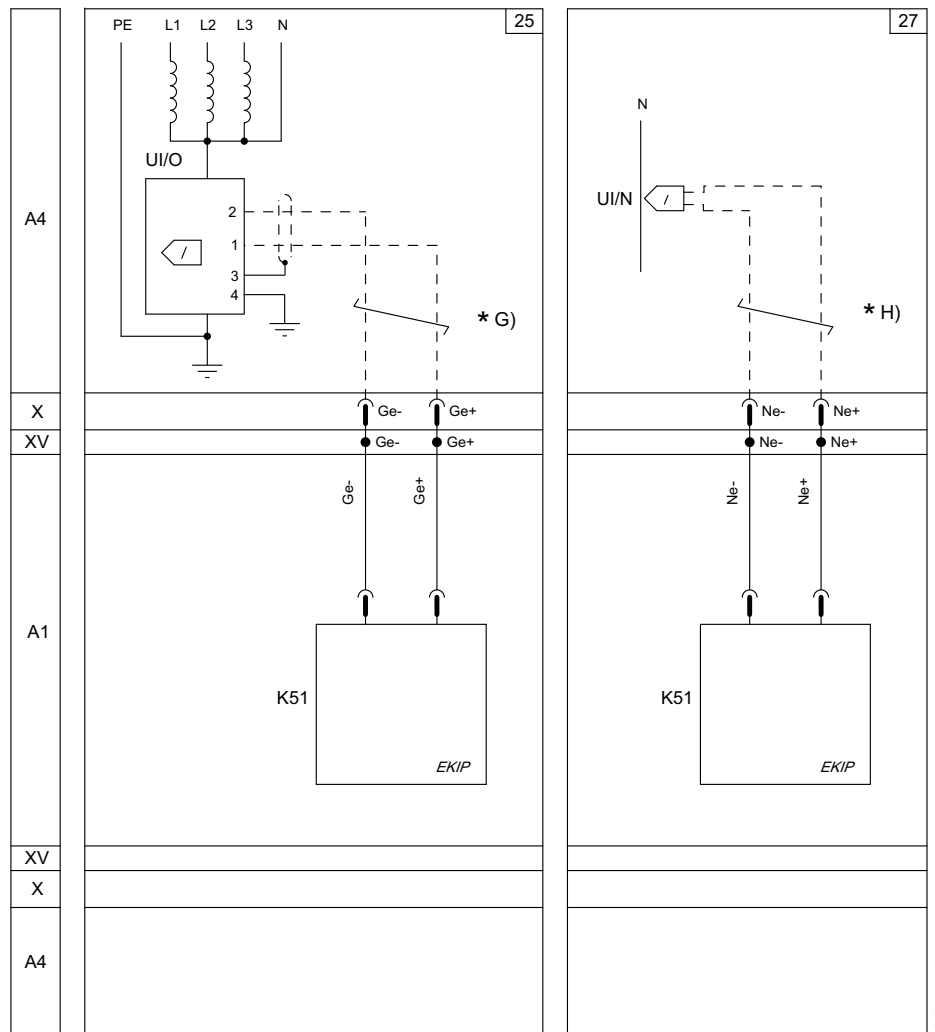

As an alternative to figure 24

Electrical diagrams

Electrical accessories

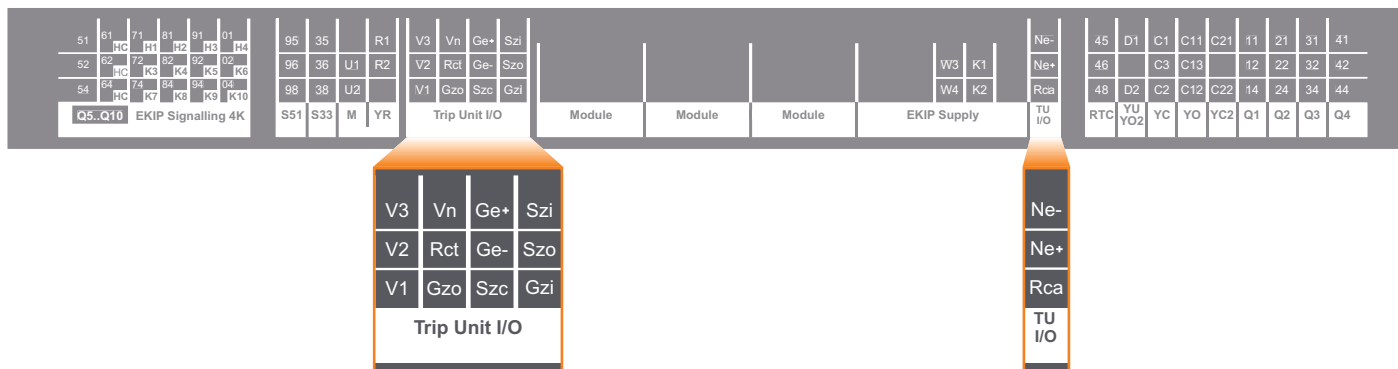

24) Rc residual current protection sensor input (ANSI 64 & 50NTD)
 24a) Rc differential ground fault protection (ANSI 87N)

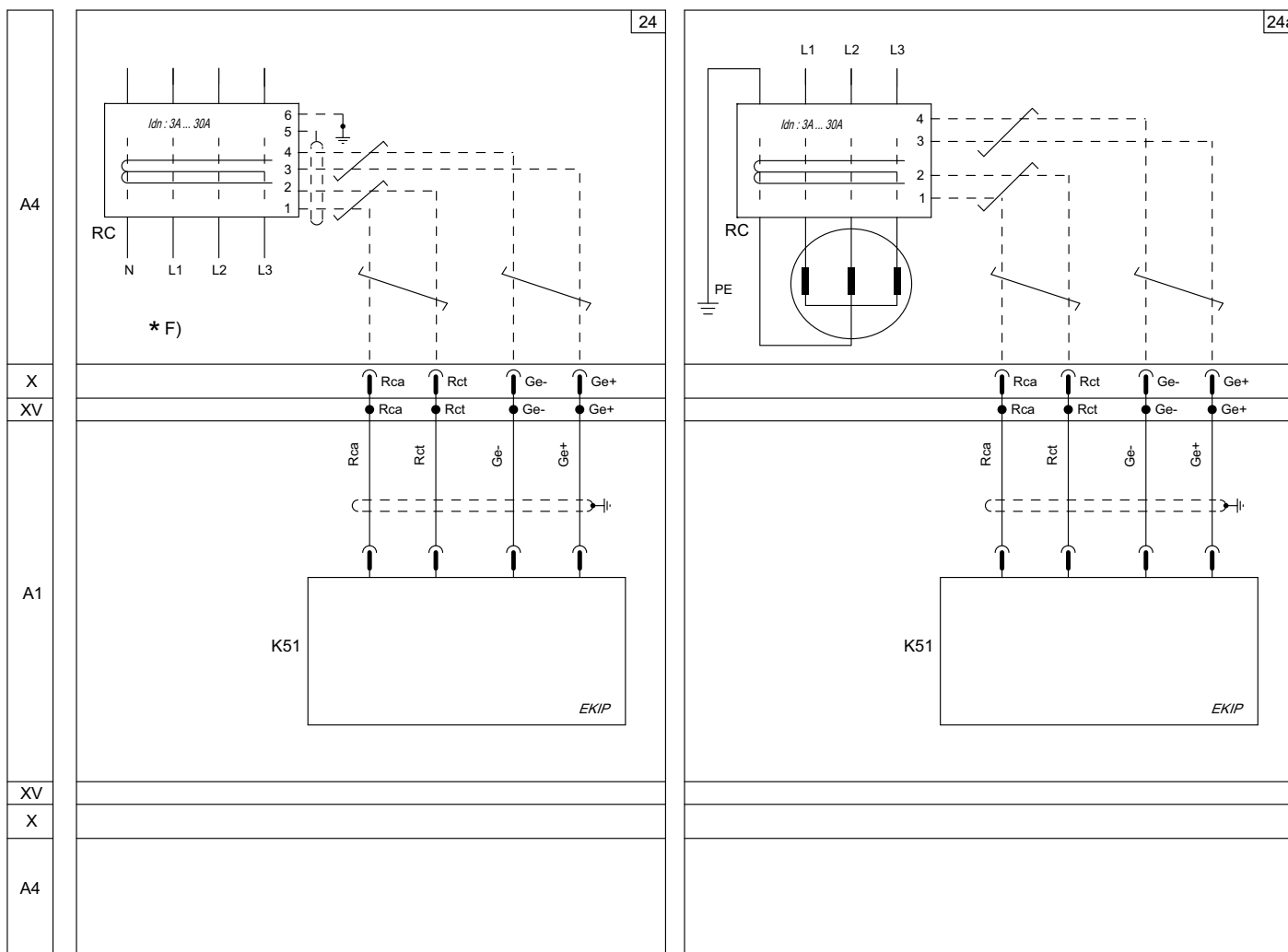

8

As an alternative to figure 25

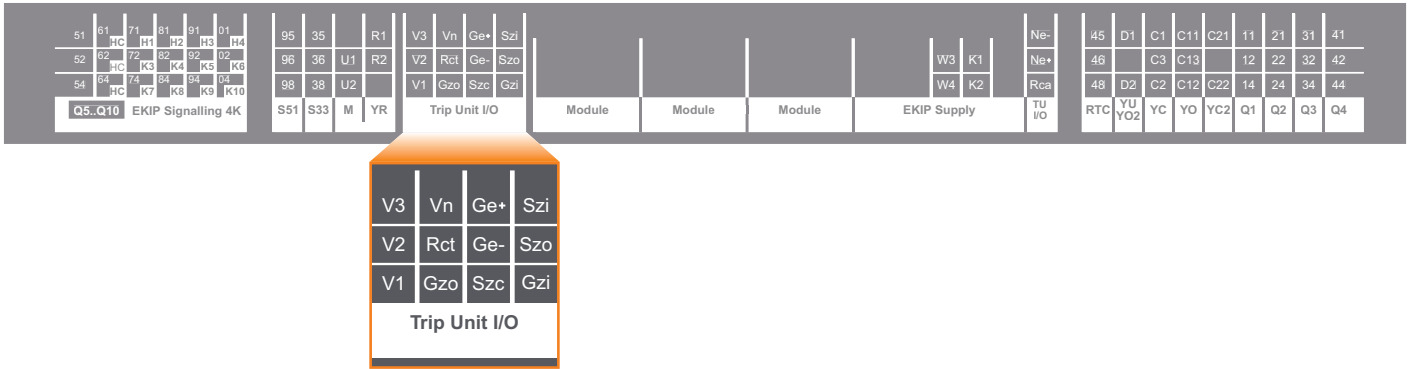

- 22) Ekip Measuring Pro for residual voltage protection (for Ekip G only)
- 23) Ekip Measuring/Measuring Pro with external voltage socket

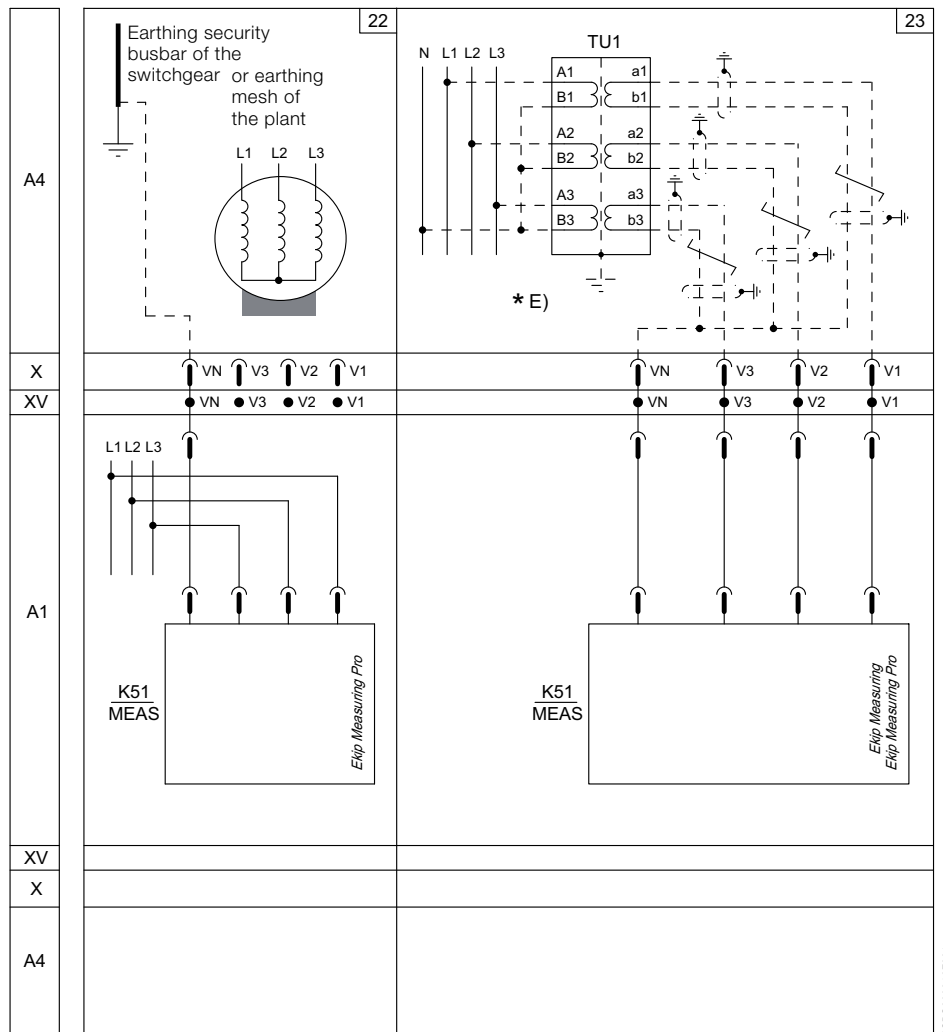

As an alternative to each other or to 20-21 diagram

Electrical diagrams

Electrical accessories

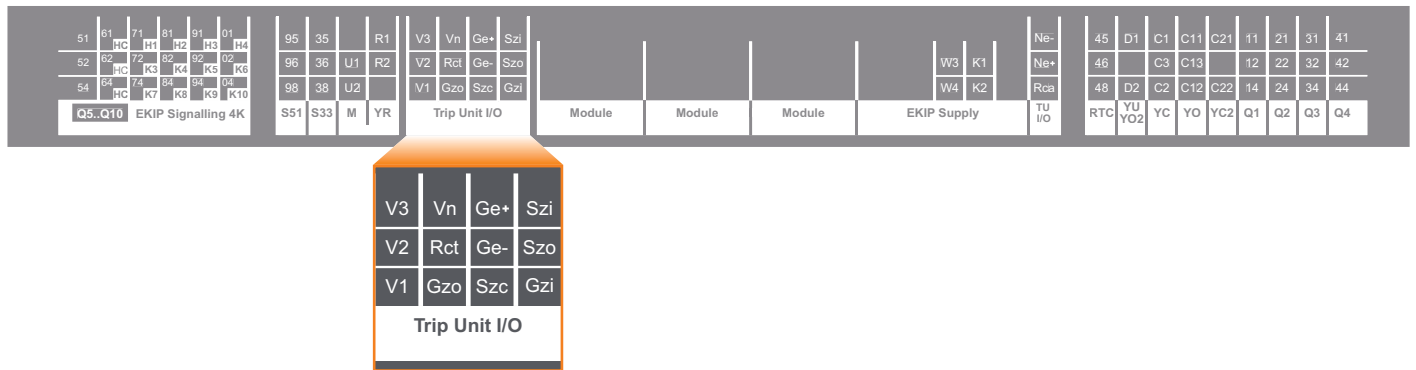

- 20) Ekip Measuring/Measuring Pro with voltage socket inside the four pole circuit-breaker
- 21) Ekip Measuring/Measuring Pro with voltage sockets inside the three-pole circuit-breaker and connection to the external neutral

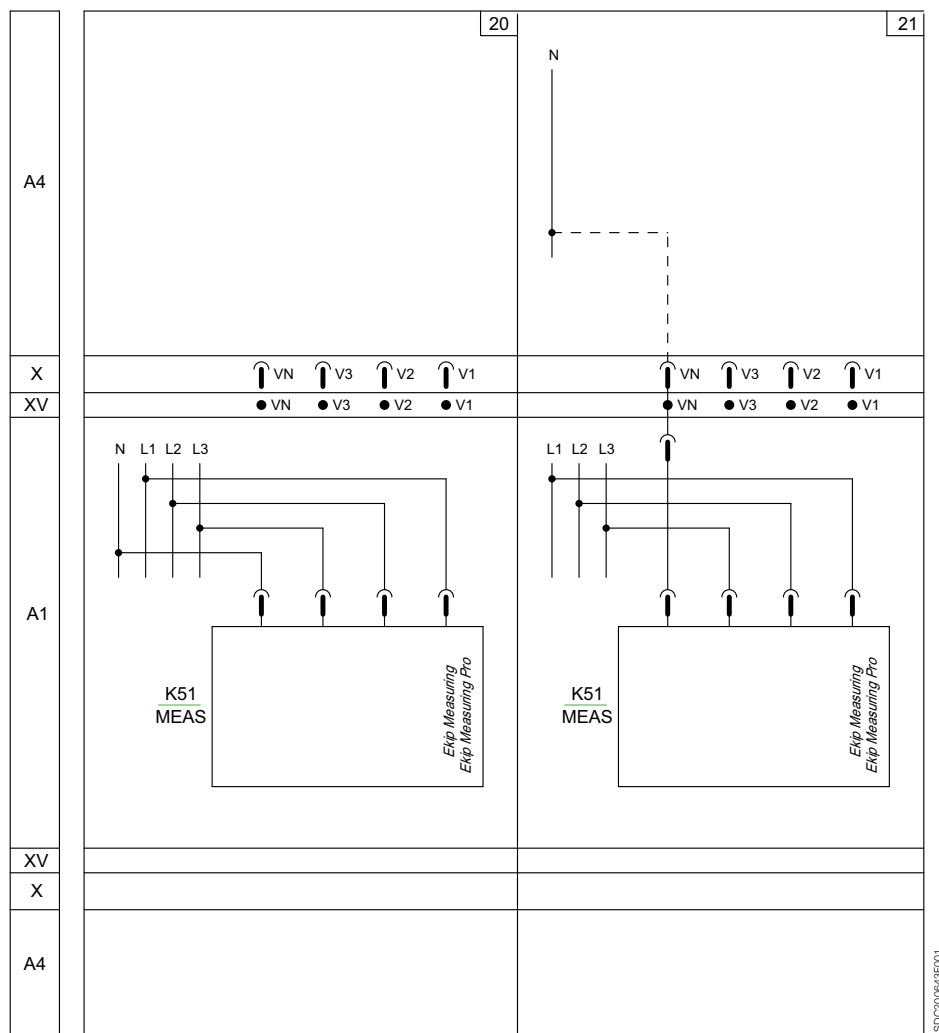

As an alternative to each other or to 22-23 diagram

Electrical diagrams

Electrical accessories

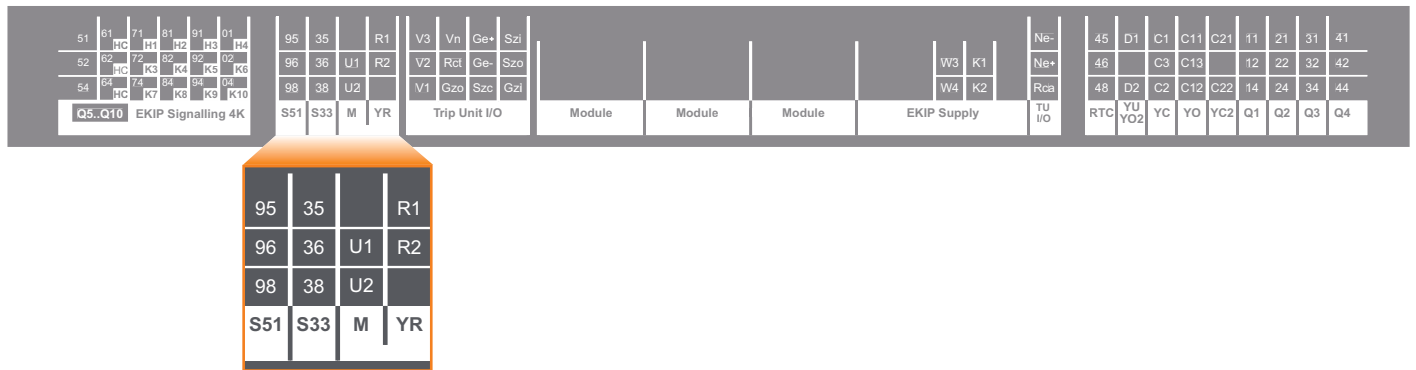

- 11) Trip signalling contact - S51
- 12) Contact for signalling position of loaded springs - S33 M/2
- 13) Motor for loading closing springs - M
- 14) Trip contact reset coil – YR

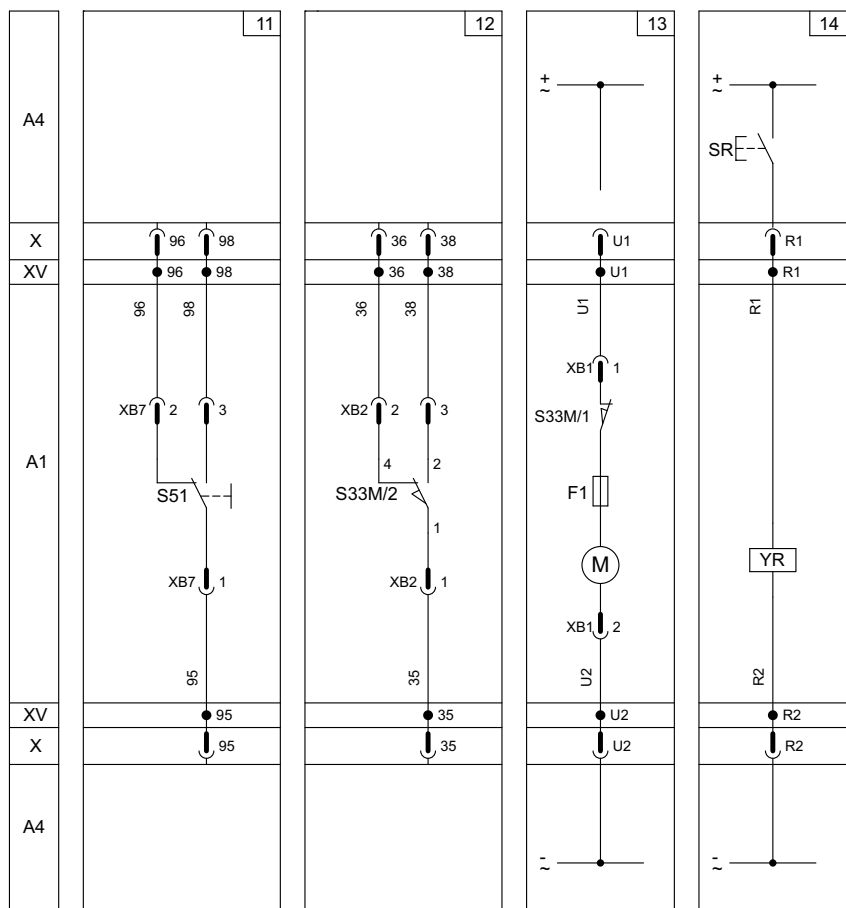

* D)

1SDC200645F001

Electrical diagrams

Electrical accessories

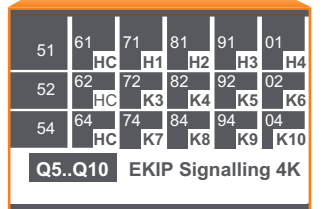
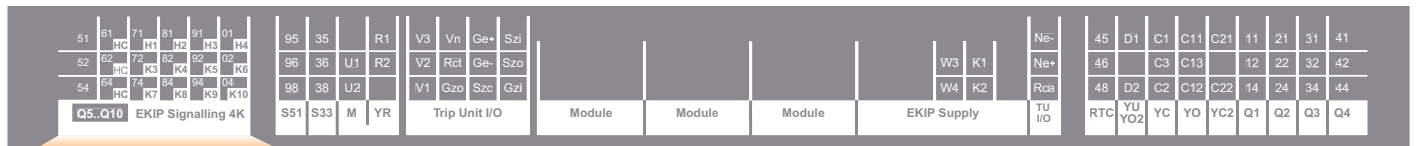

1) Supplementary open/closed auxiliary contacts of the circuit-breaker - AUX 6Q (6 Form C)

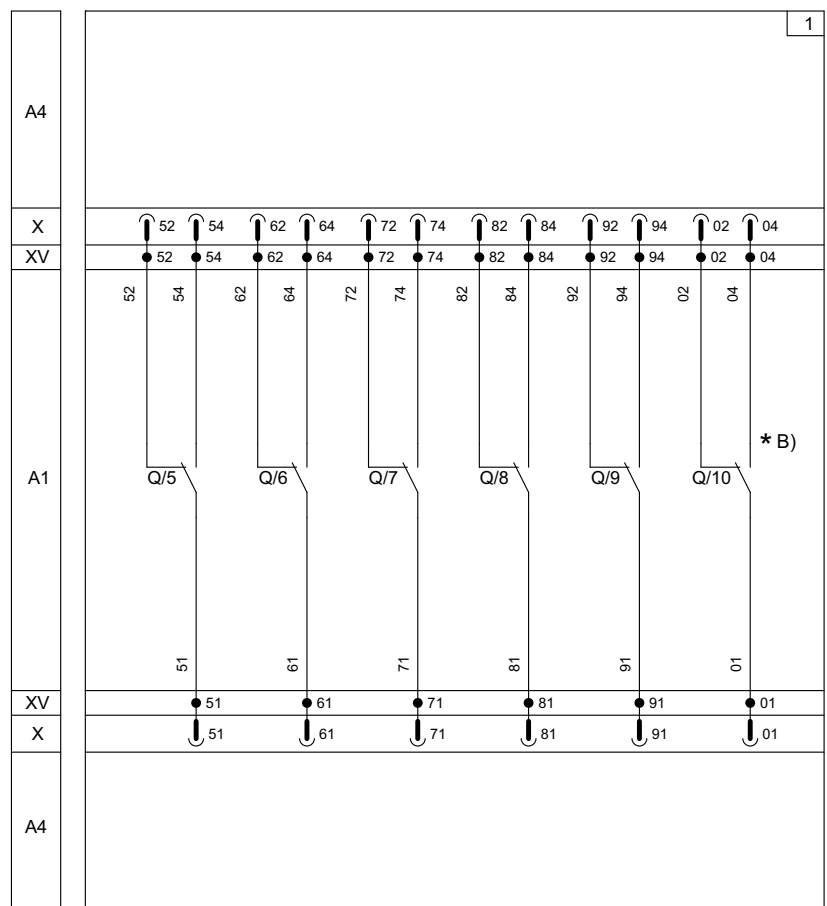

Only for circuit-breakers E2.2, E4.2, E6.2 (as an alternative to figure 2)

91) Supplementary open/closed auxiliary contacts outside the circuit-breaker - AUX 15Q (15 Form C)

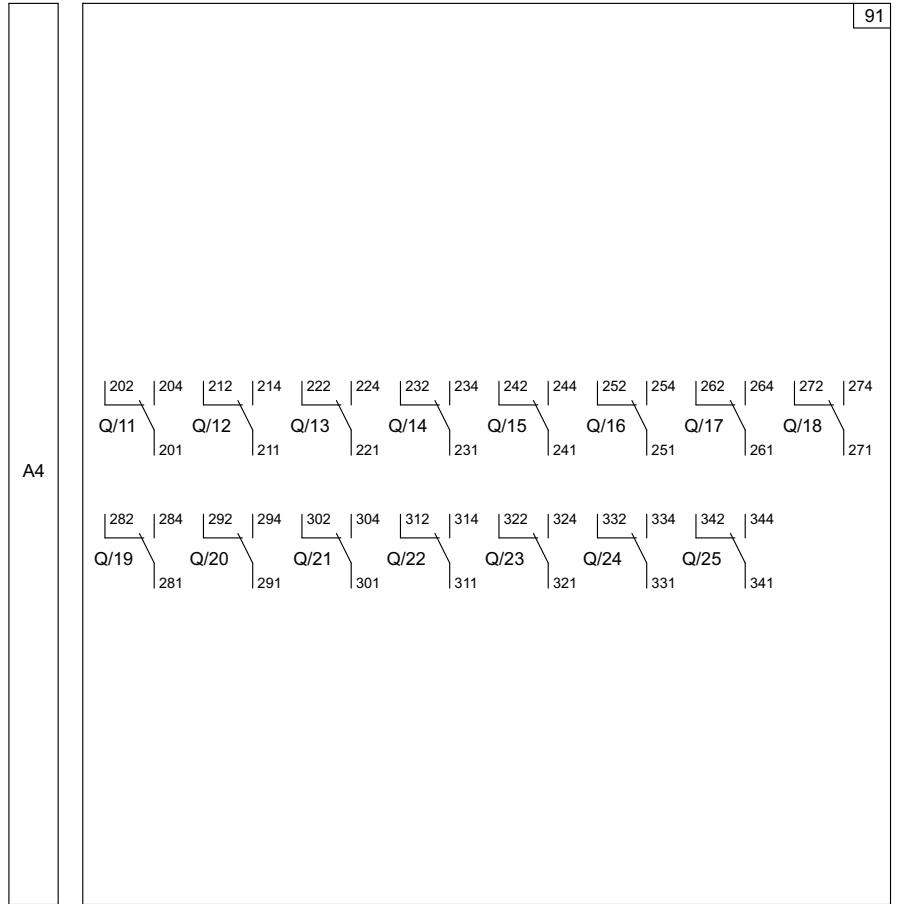

Electrical diagrams

Electrical accessories

95) Auxiliary position contacts - AUP (E1.2)

8

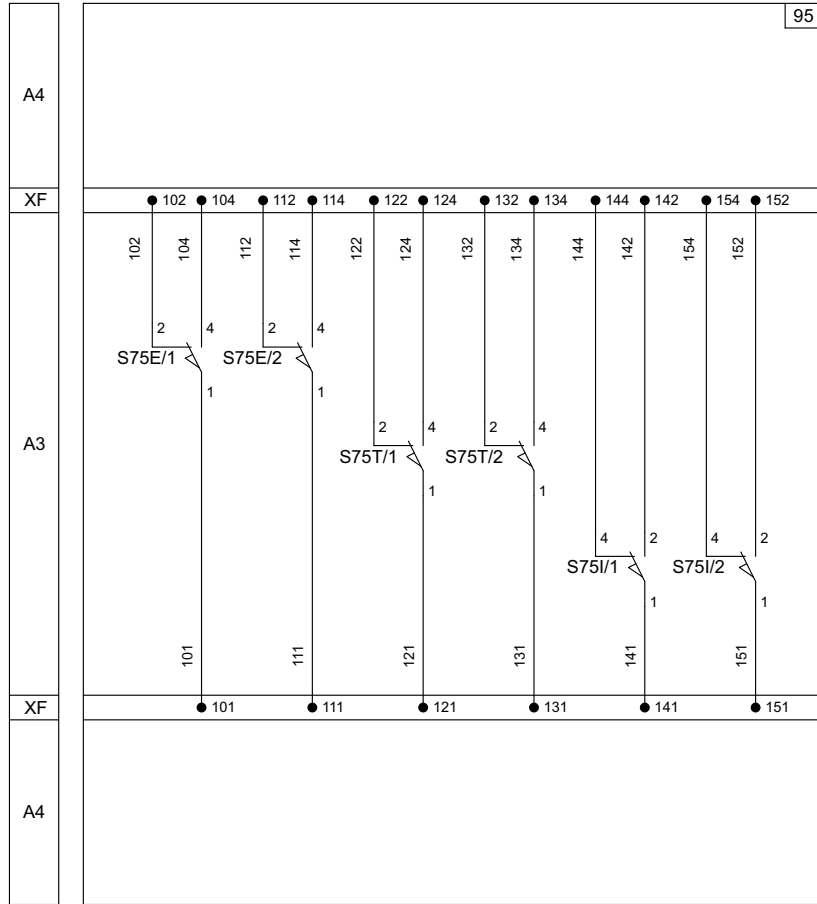

Only for circuit-breakers E1.2 in withdrawable version

96) Auxiliary position contacts - AUP (E2.2 - E6.2)

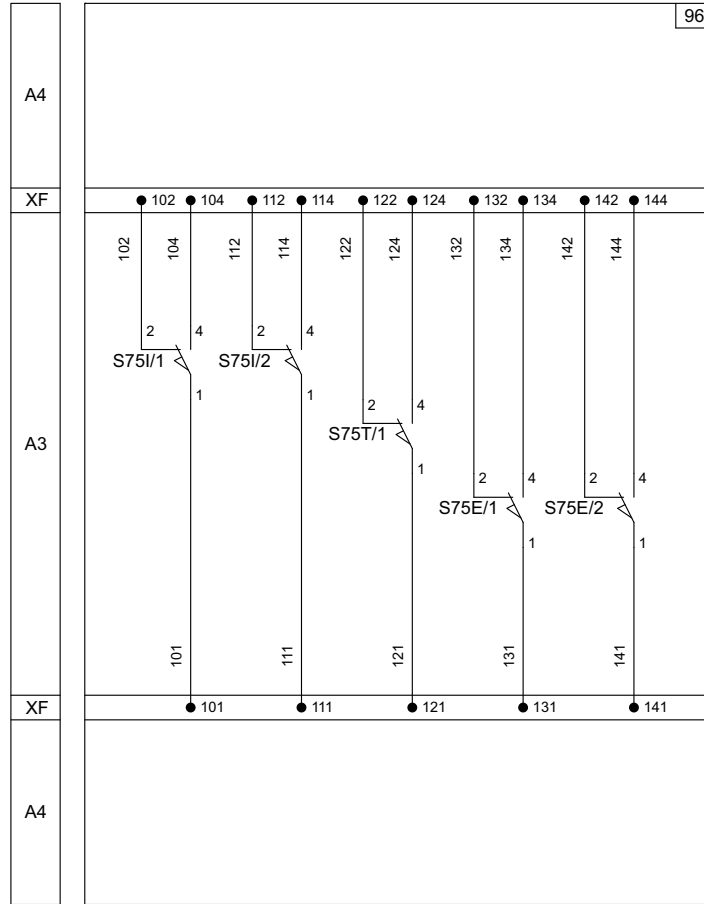

Only for circuit-breakers E2.2, E4.2, E6.2 in withdrawable version

Electrical diagrams

Electrical accessories

97) Supplementary auxiliary position contacts - AUP (E2.2 - E6.2)

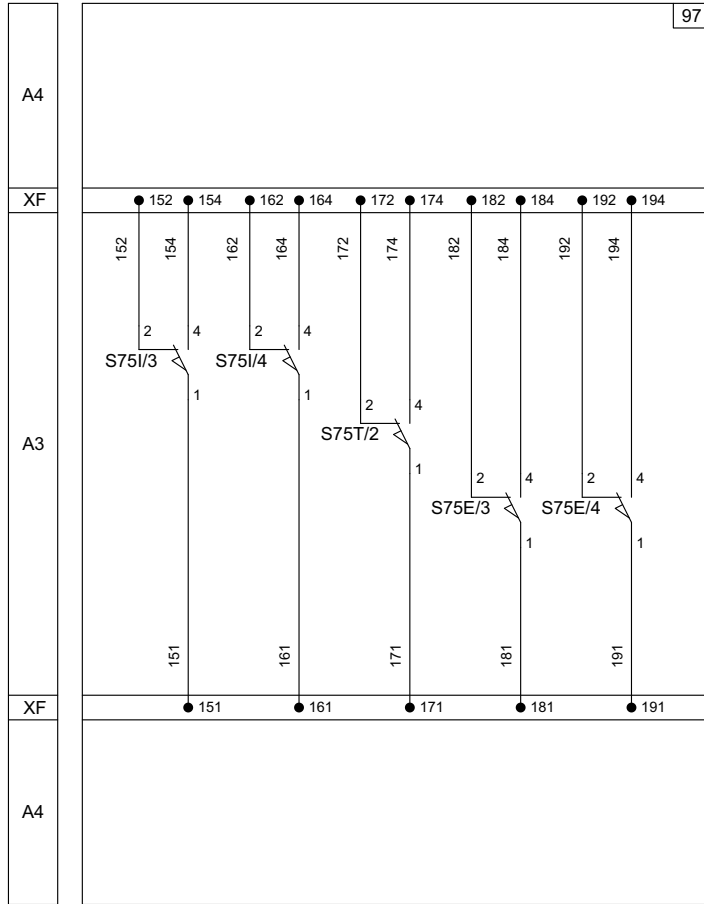

Only for circuit-breakers E2.2, E4.2, E6.2 in withdrawable version

Electrical diagrams

ATS021 and ATS022

98) Circuit-breakers without auxiliary safety voltage

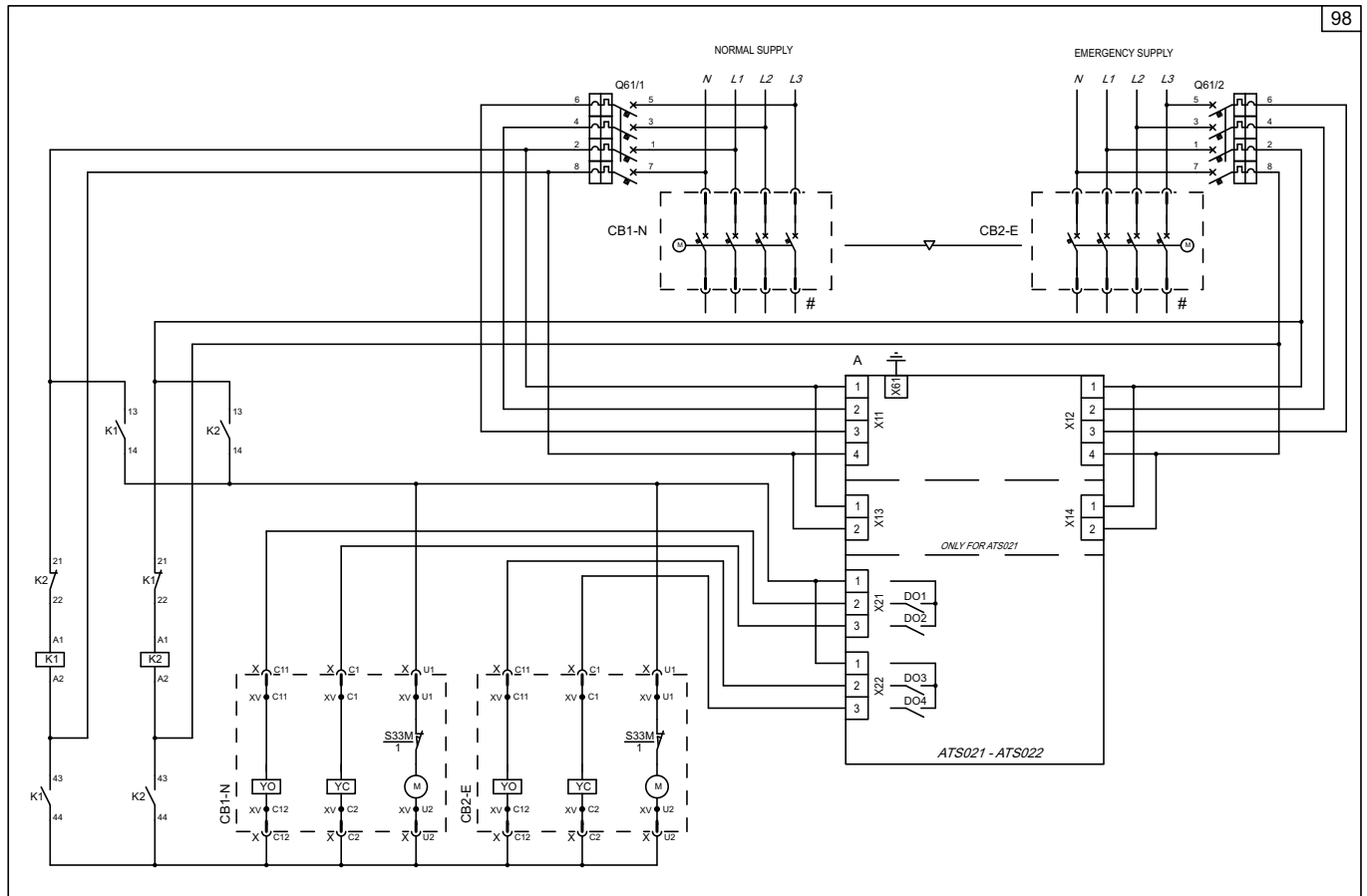

1SDC200052EN001

Electrical diagrams

ATS021 and ATS022

99) Circuit-breakers with auxiliary safety voltage in direct current

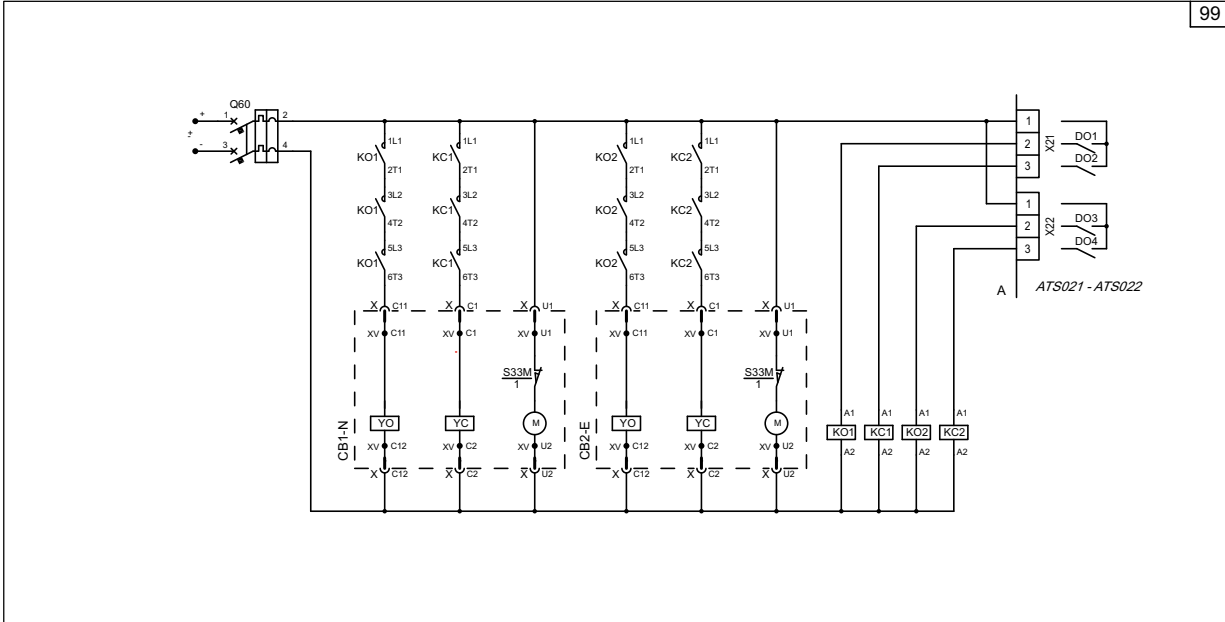

8

99) Circuit-breakers with auxiliary safety voltage in alternating current

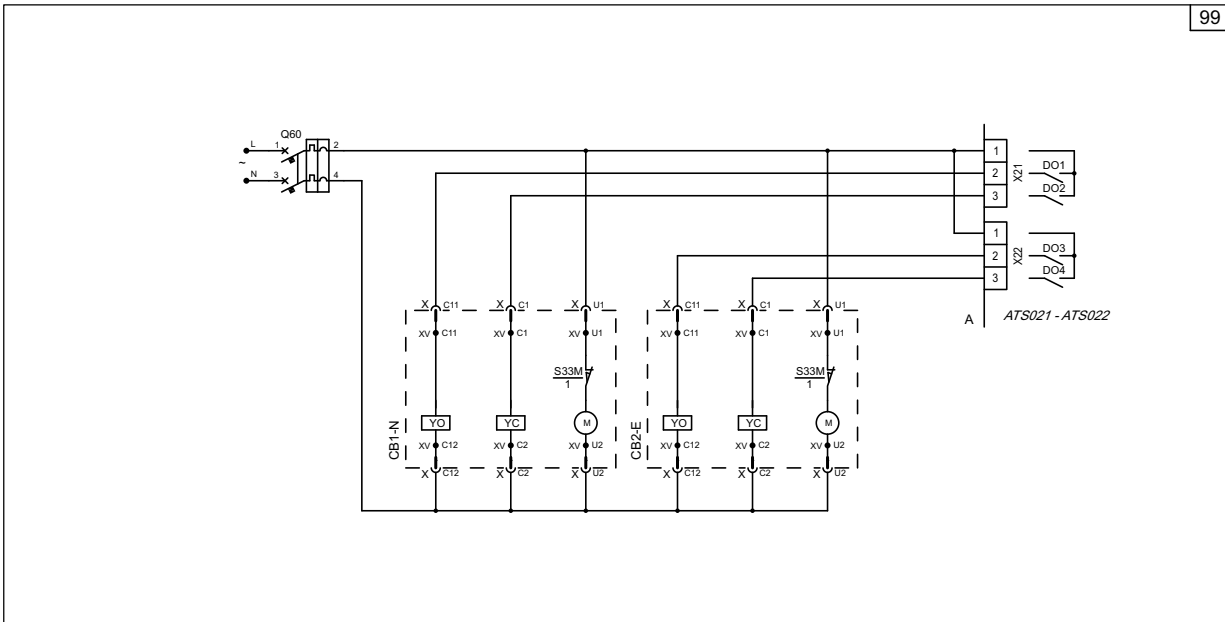

100) ATS021

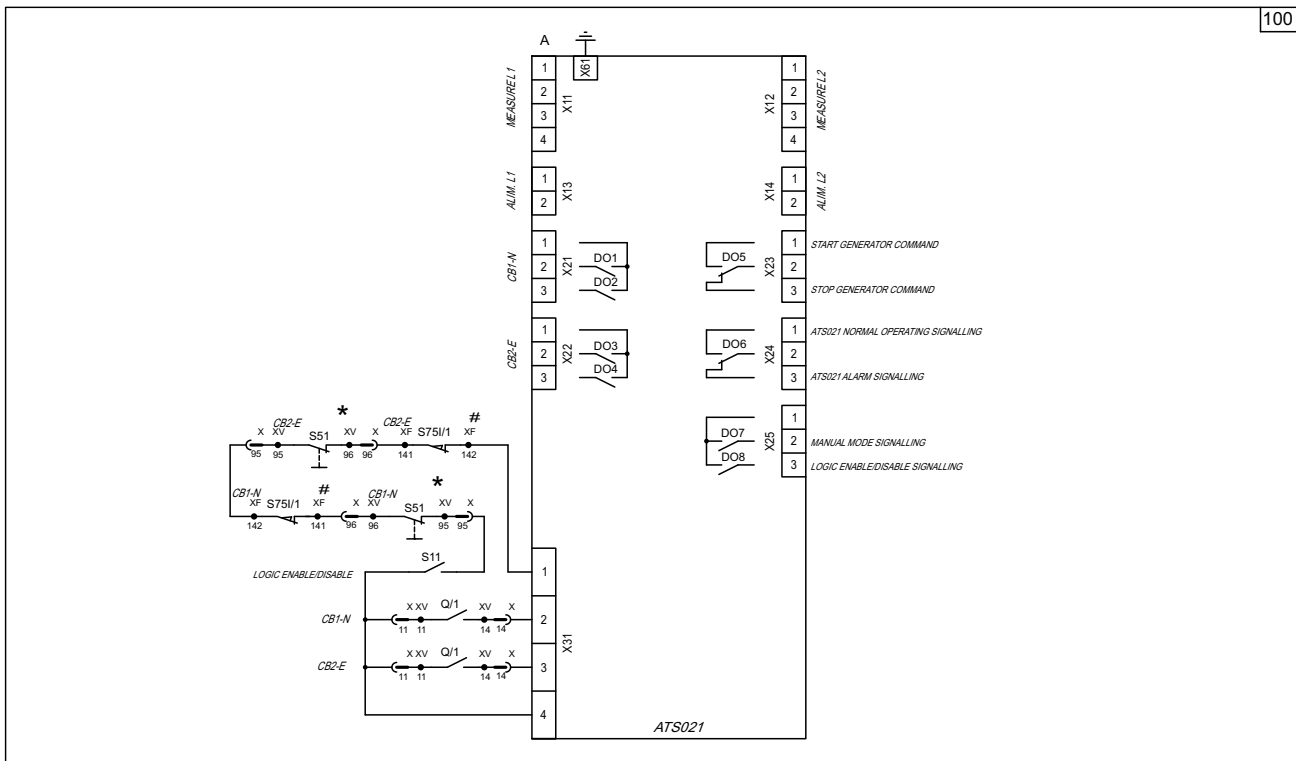

100

101) ATS022

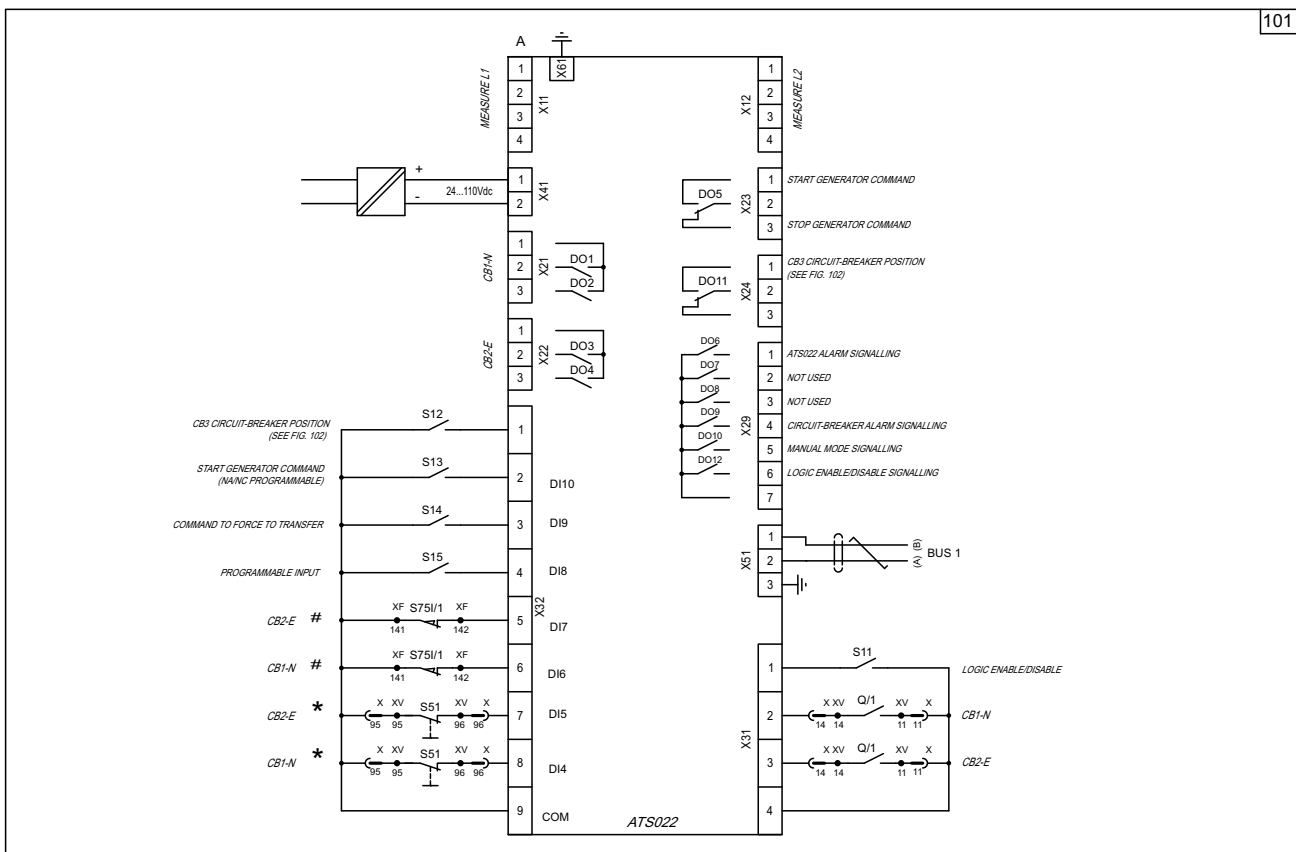

101

1SDC2006SEN7001

Electrical diagrams ATS021 and ATS022

102) Third circuit-breaker control with ATS022

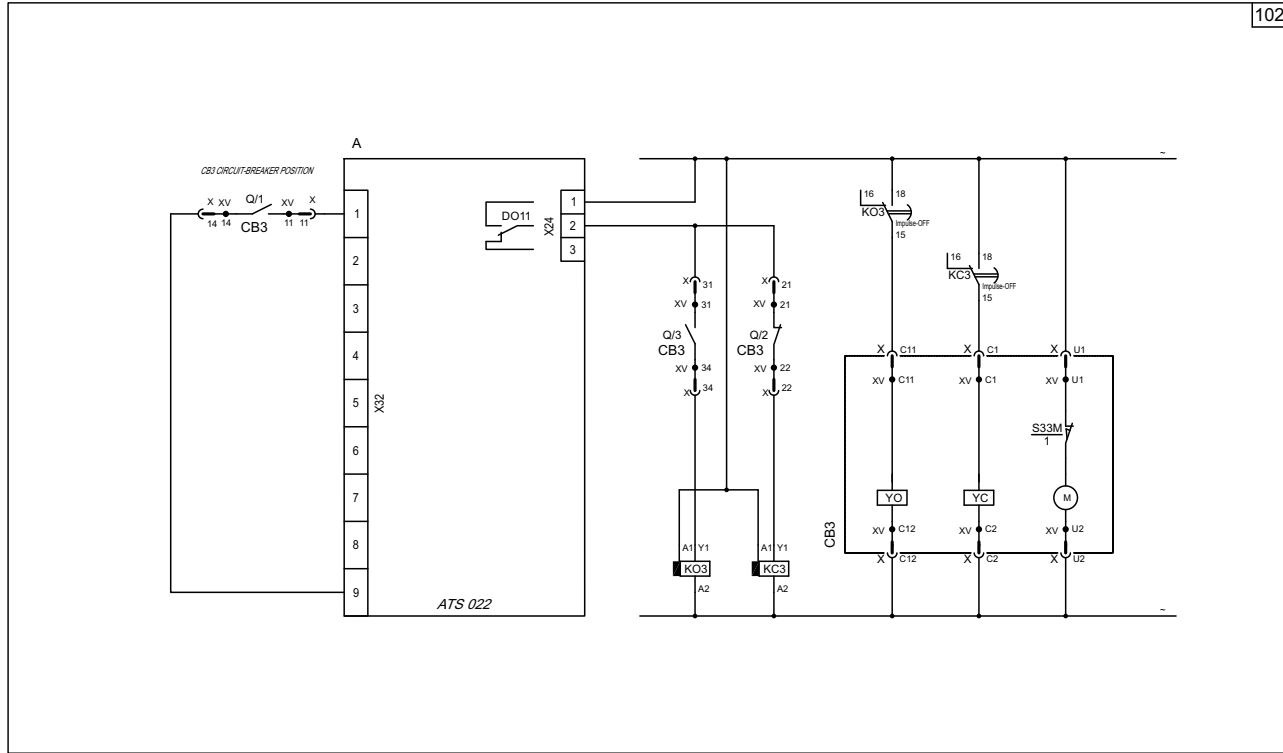

Possible configurations - ATS022 with three circuit-breakers

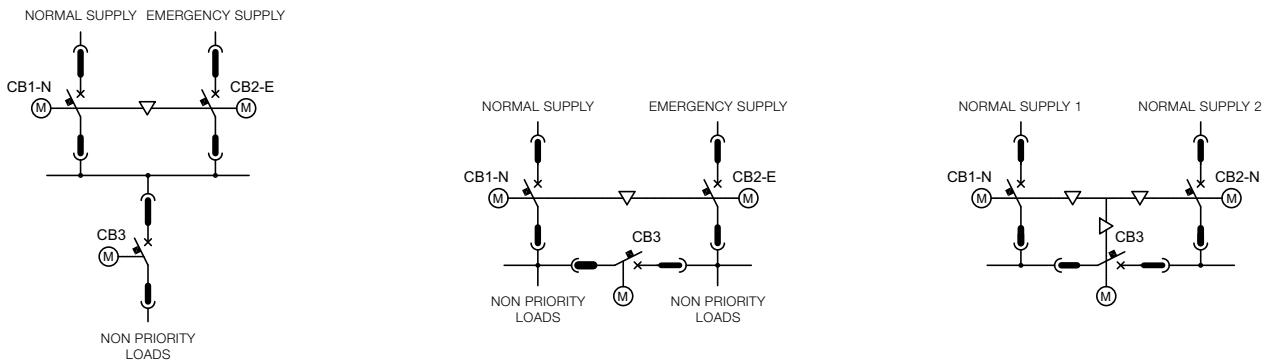

Note: Use auxiliary voltage of 110-130V AC or 220-240V AC.

Electrical diagrams

Power Controller

103) Ekip Signalling 10K

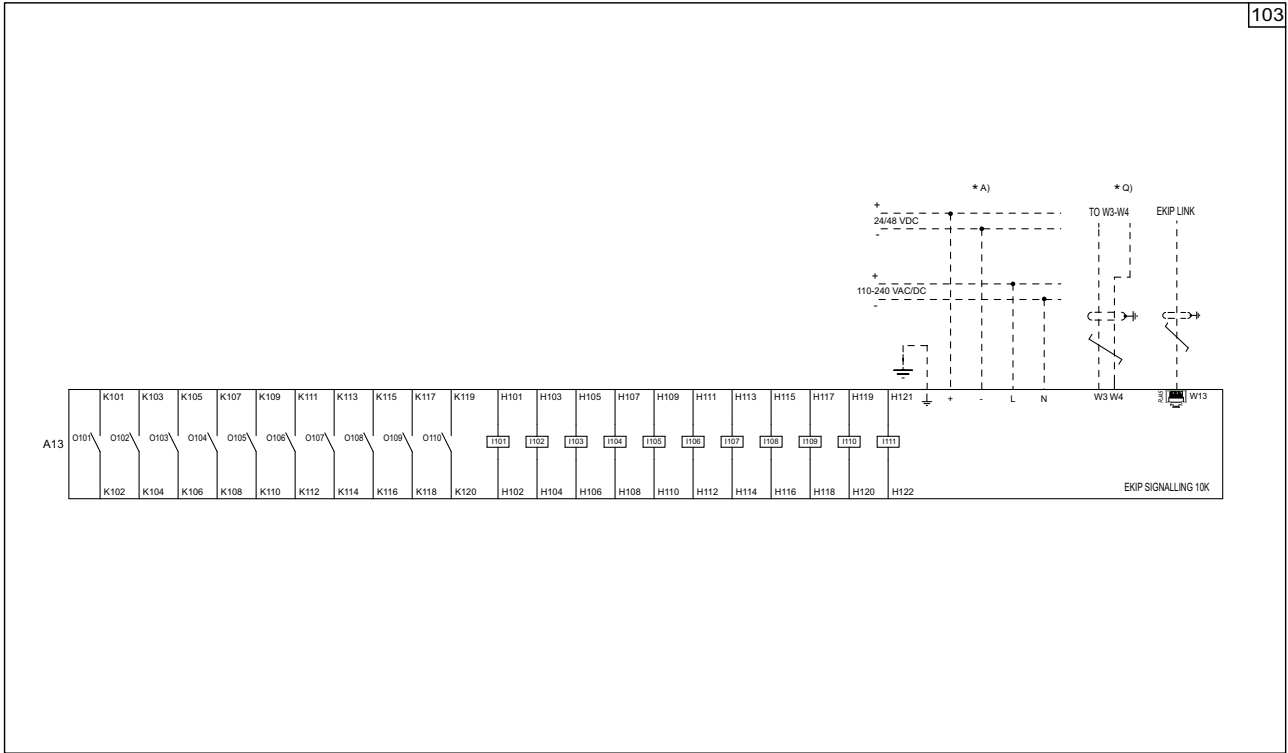

104) Ekip Multimeter

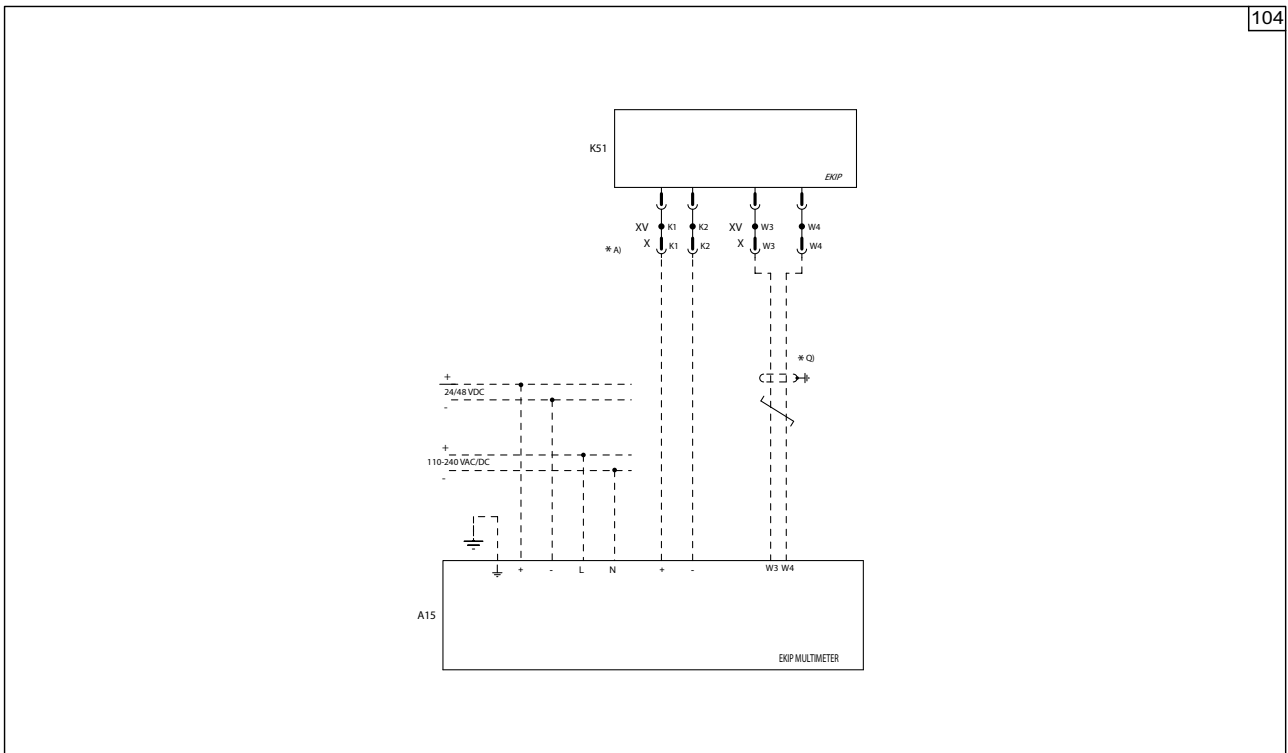

Electrical diagrams

Power Controller

105) Application diagram for Ekip Touch, Hi-Touch, G Touch, G Hi-Touch with Power Controller function

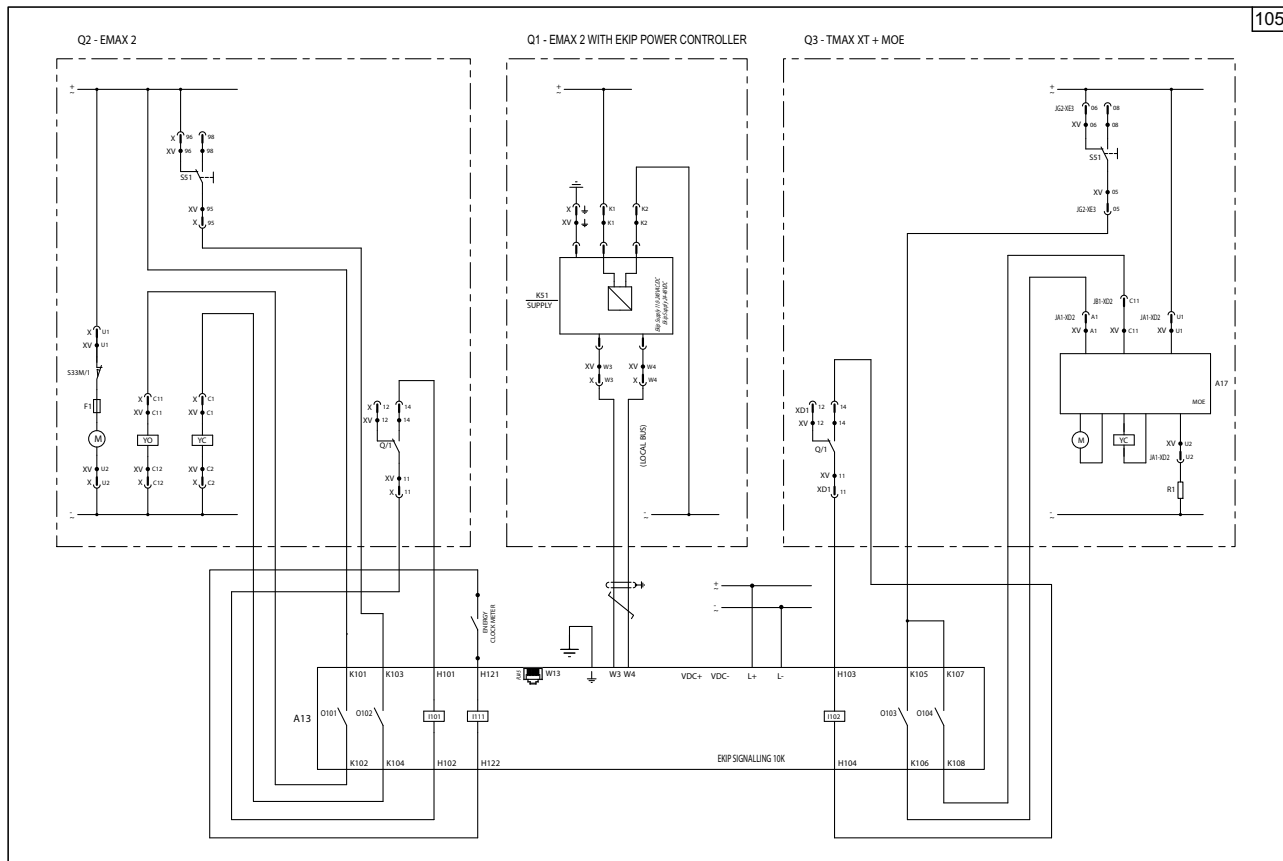
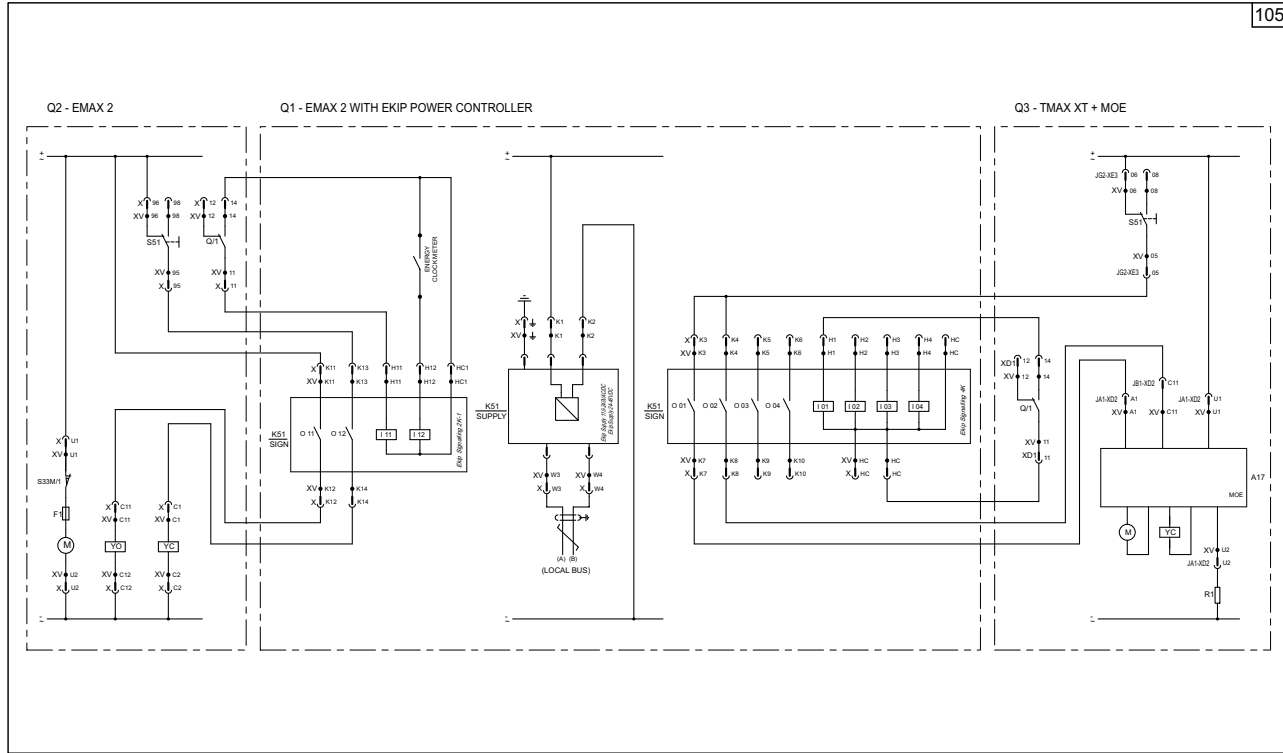

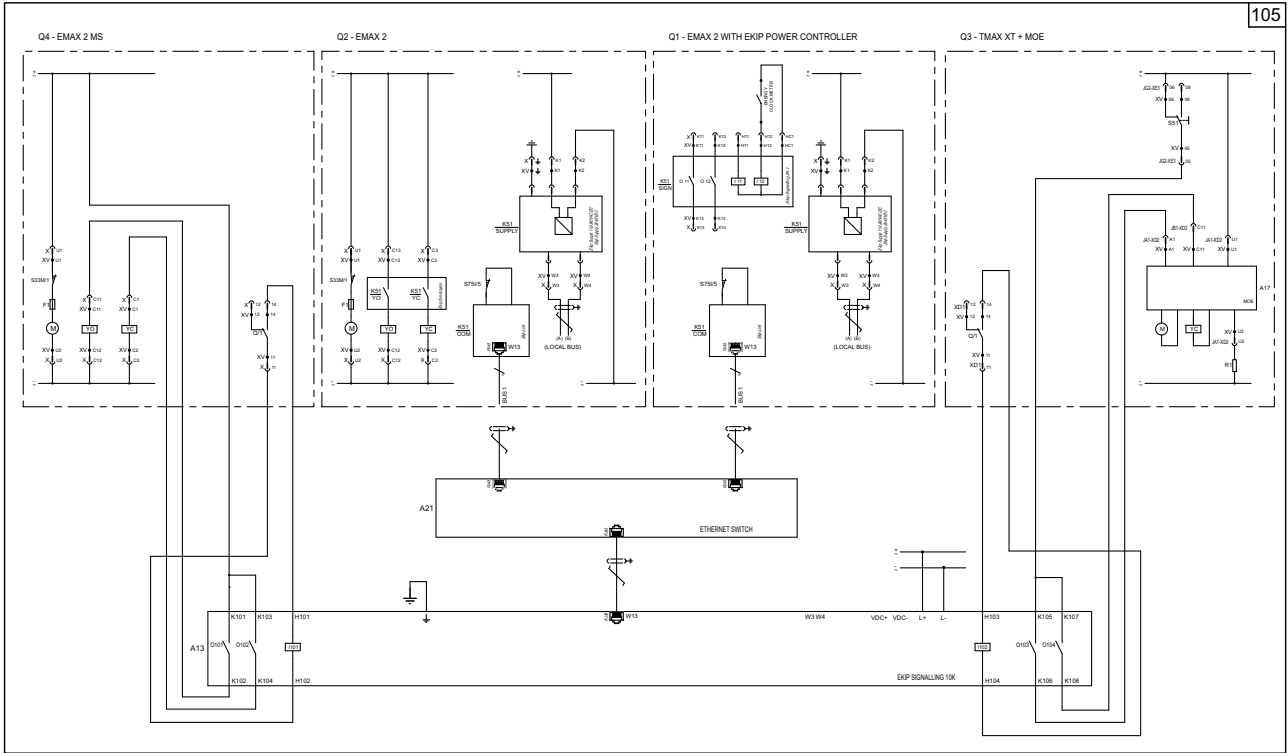

1SDC200069ENF001

Ordering codes

Instructions for ordering

Ordering examples	9/2
-------------------	-----

General information

9/5

Automatic circuit-breakers

Fixed version for power distribution	9/6
Withdrawable version for power distribution	9/21
Fixed version for generators	9/35
Withdrawable version for generators	9/40

Switch-disconnectors

Fixed version	9/45
Withdrawable version	9/48
Version for applications up to 1150V AC	9/50
Fixed version for applications up to 1000V DC	9/51
Withdrawable version for applications up to 1000V DC	9/52

Derived versions

Sectionalizing truck	9/53
Earthing truck	9/53
Earthing switch with making capacity	9/53

Fixed parts

9/54

Accessories

Electrical accessories	9/55
Mechanical accessories	9/58
Mechanical interlock	9/61
Ekip modules	9/62
Terminals	9/65

Instructions for ordering

Ordering examples

Standard version Emax 2 series circuit-breakers are identified by means of commercial codes that can be accessorized.

Ordering examples

- **Terminal kit codes** (other than standard supply) for fixed circuit-breaker or for fixed part of withdrawable circuit-breaker. The codes refer to 3 or 4 pieces (for mounting on top or bottom terminals). To convert a complete circuit-breaker, 1 kit for upper terminals and 1 kit for lower terminals must be specified in the order.

Example no. 1

Emax E2.2N 3 poles fixed with vertical rear terminals (VR)	
1SDA071066R1	E2.2N 2500 Ekip Touch LSIG 3p F HR
1SDA074009R1	Kit VR Sup E2.2 lu=2500 3pcs INST
1SDA074011R1	Kit VR Inf E2.2 lu=2500 3pcs INST

Example no. 2

Emax E1.2N 4 poles fixed with upper vertical rear (VR) and front (F) terminals (standard supply)	
1SDA071513R1	E1.2N 1600 Ekip Dip LSIG 4p F F
1SDA073986R1	Kit VR Upper E1.2 F 4pcs INST

Example no. 3

Emax E4.2H 3 poles fixed with upper front terminals (F) and adjustable rear bottom vertical (VR) terminals	
1SDA071169R1	E4.2H 3200 Ekip Hi-Touch LSIG 3p F HR
1SDA074126R1	Kit F upper E4.2 F 3pcs INST
1SDA074017R1	Kit VR lower E4.2 lu=3200 3pcs INST

Example no. 4

Emax E2.2 2000A 3 poles fixed part with spread upper vertical terminals (SVR) and rear bottom adjustable horizontal (HR) terminals (standard supply)	
1SDA073909R1	E2.2 W FP lu=2000 3p HR HR
1SDA074057R1	Kit SVR upper E2.2 lu=2000 3pcs INST

- **Rating Plug for lower values than rated current.**

Rating plug installed on the circuit-breaker enables to obtain lower current values than rated current.

Example no. 5

Emax E2.2S 2500 4 poles fixed In=1600A	
1SDA071706R1	E2.2S 2500 Ekip Touch LSIG 4p F HR
1SDA074266R1	Rating Plug 1600 E1.2..E6.2 INST

- **Special version for rated service voltages up to 1150V AC.**

Upgrade kits for SACE Emax 2 circuit-breakers enables the version for applications up to 1150V AC.

Example no. 6

Emax E6.2X 6300 4 poles fixed for applications up to 1150V AC	
1SDA071949R1	E6.2X 6300 Ekip HI-Touch LSIG 4p F HR
1SDA074347R1	E6.2X/E lu=6300 Upgrade Kit 1150V AC 4p

– **Ordering for Ekip modules.**

Ekip Supply module enables Ekip Com, Ekip Link, Ekip 2K, Ekip Syncrocheck cartridge modules to be installed.

In addition to Ekip Supply modules, up to 3 cartridge modules can be installed on E2.2, E4.2 and E6.2 and up to 2 modules on E1.2.

Example no. 7

Emax E4.2H 3 poles fixed with modules: Ekip Supply, Ekip Com Modbus TCP, Ekip Signalling 2K-1, Ekip Com Modbus TCP Redundant and Ekip Signalling 4K

1SDA071169R1	E4.2H 3200 Ekip Hi-Touch LSiG 3p F HR
1SDA074173R1	Ekip Supply 24-48V DC E1.2..E6.2
1SDA074151R1	Ekip Com Modbus TCP E1.2..E6.2
1SDA074158R1	Ekip Com R Modbus TCP E1.2..E6.2
1SDA074167R1	Ekip Sign. 2K-1 E1.2..E6.2
1SDA074170R1	Ekip Sign. 4K E2.2..E6.2

Example no. 8

Emax E4.2H 3 poles fixed with modules: Ekip Supply, Ekip Com EtherNet/IP, Ekip Com Modbus RS-485 and Ekip Measuring Pro

1SDA071166R1	E4.2H 3200 Ekip Touch LSiG 3p F HR
1SDA074173R1	Ekip Supply 24-48V DC E1.2..E6.2
1SDA074155R1	Ekip Com EtherNet/IP E1.2..E6.2
1SDA074150R1	Ekip Com Modbus RS-485 E1.2..E6.2
1SDA074189R1	Ekip Measuring Pro E4.2

Example no. 9

Emax E1.2N 4 poles fixed with modules: Ekip Supply, Ekip Link

1SDA071513R1	E1.2N 1600 Ekip Dip LSiG 4p F F
1SDA074172R1	Ekip Supply 110-240V AC/DC E1.2..E6.2
1SDA074163R1	Ekip Link E1.2..E6.2

– **Ordering for electrical accessories.**

All the accessories are available. In particular, up to 3 coils can be ordered for E1.2, whereas up to 4 coils for E2.2, E4.2 and E6.2.

Example no. 10

Emax E2.2S 3 poles withdrawable with accessories: opening release, closing release, motor for automatic charging of the springs, second opening release

1SDA072395R1	E2.2S 2000 Ekip Touch LSi LSiG 3p WMP
1SDA073674R1	YO E1.2..E6.2 220-240V AC/DC
1SDA073687R1	YC E1.2..E6.2 220-240V AC/DC
1SDA073725R1	M E2.2..E6.2 220-250V AC/DC
1SDA073674R1	YO E1.2..E6.2 220-240V AC/DC

– **Ordering for key locks.**

Example no. 11

Emax E2.2N 3 poles with double key lock in racked-in / test / racked-out position, using different keys

1SDA071066R1	E2.2N 2500 Ekip Touch LSiG 3p F HR
1SDA073806R1	KLP-D Bl. Racked in/out E2.2...E6.2 1st key
1SDA073812R1	KLP-D Bl. Racked in/out E2.2...E6.2 2nd key

Instructions for ordering

Ordering examples

– Ordering for mechanical Interlocks.

Interlocks have several strategy configuration, suitable for fixed circuit-breakers and withdrawable circuit-breakers.

Each configuration requires different groups:

- **Cables**, select one Kit for strategy A / B / C / D. The cables must be ordered on fixed circuit-breaker or fixed part of withdrawable circuit-breaker.
- **Lever**, required only for E2.2, E4.2 and E6.2. These lever must be mounted on fixed circuit-breaker or on mobile part of withdrawable circuit-breaker.
- **Support**, installed on fixed circuit-breaker or on fixed part of withdrawable circuit-breaker. This support is mounted on the external right side of the circuit-breaker.

Example no. 12

Interlock between two fixed circuit-breakers: E1.2 and E2.2

E1.2 Fixed circuit-breaker	E2.2 Fixed circuit-breaker
Cables [Group 1]: 1 Item	Lever [Group 2]: 1 Item
Support [Group 3]: 1 Item	Support [Group 3]: 1 Item

Example no. 13

Interlock between three fixed circuit-breakers: one E2.2 and two E4.2

E2.2 Fixed circuit-breaker	E4.2 Fixed circuit-breaker	E4.2 Fixed circuit-breaker
Cables [Group 1]: 1 Item	Lever [Group 2]: 1 Item	Lever [Group 2]: 1 Item
Lever [Group 2]: 1 Item	Support [Group 3]: 1 Item	Support [Group 3]: 1 Item
Support [Group 3]: 1 Item		

Example no. 14

Interlock between two withdrawable circuit-breakers: E1.2 and E2.2

E1.2 Fixed Part	E2.2 Mobile Part
Cables [Group 1]: 1 Item	Lever [Group 2]: 1 Item
Support [Group 4]: 1 Item	+
	E2.2 Fixed Part
	Support [Group 4]: 1 Item

Example no. 15

Interlock between three withdrawable circuit-breakers: one E2.2 and two E4.2

E2.2 Mobile Part	E4.2 Mobile Part	E4.2 Mobile Part
Lever [Group 2]: 1 Item	Lever [Group 2]: 1 Item	Lever [Group 2]: 1 Item
+		
E2.2 Fixed Part	E4.2 Fixed Part	E4.2 Fixed Part
Cables [Group 1]: 1 Item	Support [Group 4]: 1 Item	Support [Group 4]: 1 Item
Support [Group 4]: 1 Item		

General informations

Abbreviations used for the description of the product

Versions and terminals

F	Fixed circuit-breaker
W	Withdrawable circuit-breaker
MP	Mobile part of withdrawable circuit-breaker
FP	Fixed part of withdrawable circuit-breaker
Iu	Rated uninterrupted current
In	Rated current of the rating plug
Icu	Rated ultimate short-circuit breaking capacity
Icw	Rated short-time withstand current
/MS	Switch-disconnector
/E	Circuit-breakers for 1150V applications
/f	Four-pole circuit-breakers with neutral pole at 100%
CS	Sectionalizing truck
MT	Earthing truck
MTP	Earthing switch with making capacity
HR VR	Rear orientable terminals
SHR	Horizontal rear spread terminals
SVR	Vertical rear spread terminals
F	Front terminals
FL	Flat terminals
EF	Extended front terminals
ES	Front spread terminals
Fc CuAl	Terminals for cables

Protection trip units and functions

Ekip Dip	Protection trip unit for power distribution
Ekip Touch	Measurement and protection trip unit for power distribution
Ekip Hi Touch	Measurement and protection trip unit and network analyzer for power distribution
Ekip G Touch	Measurement and protection trip unit for generators
Ekip G Hi-Touch	Measurement and protection trip unit and protection network analyzer for generators
L	Overload protection
S	Protection against selective short circuit
I	Protection against instantaneous short circuit
G	Earth fault protection
Rc	Residual current protection
Power Controller	Load management function

Automatic circuit-breakers

Fixed version for power distribution



SACE Emax E1.2B • Front terminals (F)

Size	Iu	Icu (440 V)	Icw (1s)	Type	3 Poles		4 Poles	
					Code		Code	
E1.2B	630	42	42	E1.2B 630 Ekip Dip LI	1SDA070701R1		1SDA071331R1	
				E1.2B 630 Ekip Dip LSI	1SDA070702R1		1SDA071332R1	
				E1.2B 630 Ekip Dip LSIG	1SDA070703R1		1SDA071333R1	
				E1.2B 630 Ekip Touch LI	1SDA070704R1		1SDA071334R1	
				E1.2B 630 Ekip Touch LSI	1SDA070705R1		1SDA071335R1	
				E1.2B 630 Ekip Touch LSIG	1SDA070706R1		1SDA071336R1	
				E1.2B 630 Ekip Hi-Touch LSI	1SDA070708R1		1SDA071338R1	
				E1.2B 630 Ekip Hi-Touch LSIG	1SDA070709R1		1SDA071339R1	
	800	42	42	E1.2B 800 Ekip Dip LI	1SDA070741R1		1SDA071371R1	
				E1.2B 800 Ekip Dip LSI	1SDA070742R1		1SDA071372R1	
				E1.2B 800 Ekip Dip LSIG	1SDA070743R1		1SDA071373R1	
				E1.2B 800 Ekip Touch LI	1SDA070744R1		1SDA071374R1	
				E1.2B 800 Ekip Touch LSI	1SDA070745R1		1SDA071375R1	
				E1.2B 800 Ekip Touch LSIG	1SDA070746R1		1SDA071376R1	
				E1.2B 800 Ekip Hi-Touch LSI	1SDA070748R1		1SDA071378R1	
				E1.2B 800 Ekip Hi-Touch LSIG	1SDA070749R1		1SDA071379R1	
	1000	42	42	E1.2B 1000 Ekip Dip LI	1SDA070781R1		1SDA071411R1	
				E1.2B 1000 Ekip Dip LSI	1SDA070782R1		1SDA071412R1	
				E1.2B 1000 Ekip Dip LSIG	1SDA070783R1		1SDA071413R1	
				E1.2B 1000 Ekip Touch LI	1SDA070784R1		1SDA071414R1	
				E1.2B 1000 Ekip Touch LSI	1SDA070785R1		1SDA071415R1	
				E1.2B 1000 Ekip Touch LSIG	1SDA070786R1		1SDA071416R1	
				E1.2B 1000 Ekip Hi-Touch LSI	1SDA070788R1		1SDA071418R1	
				E1.2B 1000 Ekip Hi-Touch LSIG	1SDA070789R1		1SDA071419R1	
	1250	42	42	E1.2B 1250 Ekip Dip LI	1SDA070821R1		1SDA071451R1	
				E1.2B 1250 Ekip Dip LSI	1SDA070822R1		1SDA071452R1	
				E1.2B 1250 Ekip Dip LSIG	1SDA070823R1		1SDA071453R1	
				E1.2B 1250 Ekip Touch LI	1SDA070824R1		1SDA071454R1	
E1.2B 1250 Ekip Touch LSI				1SDA070825R1		1SDA071455R1		
E1.2B 1250 Ekip Touch LSIG				1SDA070826R1		1SDA071456R1		
E1.2B 1250 Ekip Hi-Touch LSI				1SDA070828R1		1SDA071458R1		
E1.2B 1250 Ekip Hi-Touch LSIG				1SDA070829R1		1SDA071459R1		
1600	42	42	E1.2B 1600 Ekip Dip LI	1SDA070861R1		1SDA071491R1		
			E1.2B 1600 Ekip Dip LSI	1SDA070862R1		1SDA071492R1		
			E1.2B 1600 Ekip Dip LSIG	1SDA070863R1		1SDA071493R1		
			E1.2B 1600 Ekip Touch LI	1SDA070864R1		1SDA071494R1		
			E1.2B 1600 Ekip Touch LSI	1SDA070865R1		1SDA071495R1		
			E1.2B 1600 Ekip Touch LSIG	1SDA070866R1		1SDA071496R1		
			E1.2B 1600 Ekip Hi-Touch LSI	1SDA070868R1		1SDA071498R1		
			E1.2B 1600 Ekip Hi-Touch LSIG	1SDA070869R1		1SDA071499R1		



1SDC20061F001

SACE Emax E1.2C • Front terminals (F)

Size	Iu	Icu (440 V)	Icw (1s)	Type	3 Poles		4 Poles	
					Code		Code	
E1.2C	630	50	42	E1.2C 630 Ekip Dip LI	1SDA070711R1		1SDA071341R1	
				E1.2C 630 Ekip Dip LSI	1SDA070712R1		1SDA071342R1	
				E1.2C 630 Ekip Dip LSIG	1SDA070713R1		1SDA071343R1	
				E1.2C 630 Ekip Touch LI	1SDA070714R1		1SDA071344R1	
				E1.2C 630 Ekip Touch LSI	1SDA070715R1		1SDA071345R1	
				E1.2C 630 Ekip Touch LSIG	1SDA070716R1		1SDA071346R1	
				E1.2C 630 Ekip Hi-Touch LSI	1SDA070718R1		1SDA071348R1	
				E1.2C 630 Ekip Hi-Touch LSIG	1SDA070719R1		1SDA071349R1	
	800	50	42	E1.2C 800 Ekip Dip LI	1SDA070751R1		1SDA071381R1	
				E1.2C 800 Ekip Dip LSI	1SDA070752R1		1SDA071382R1	
				E1.2C 800 Ekip Dip LSIG	1SDA070753R1		1SDA071383R1	
				E1.2C 800 Ekip Touch LI	1SDA070754R1		1SDA071384R1	
				E1.2C 800 Ekip Touch LSI	1SDA070755R1		1SDA071385R1	
				E1.2C 800 Ekip Touch LSIG	1SDA070756R1		1SDA071386R1	
				E1.2C 800 Ekip Hi-Touch LSI	1SDA070758R1		1SDA071388R1	
				E1.2C 800 Ekip Hi-Touch LSIG	1SDA070759R1		1SDA071389R1	
	1000	50	42	E1.2C 1000 Ekip Dip LI	1SDA070791R1		1SDA071421R1	
				E1.2C 1000 Ekip Dip LSI	1SDA070792R1		1SDA071422R1	
				E1.2C 1000 Ekip Dip LSIG	1SDA070793R1		1SDA071423R1	
				E1.2C 1000 Ekip Touch LI	1SDA070794R1		1SDA071424R1	
				E1.2C 1000 Ekip Touch LSI	1SDA070795R1		1SDA071425R1	
				E1.2C 1000 Ekip Touch LSIG	1SDA070796R1		1SDA071426R1	
				E1.2C 1000 Ekip Hi-Touch LSI	1SDA070798R1		1SDA071428R1	
				E1.2C 1000 Ekip Hi-Touch LSIG	1SDA070799R1		1SDA071429R1	
	1250	50	42	E1.2C 1250 Ekip Dip LI	1SDA070831R1		1SDA071461R1	
				E1.2C 1250 Ekip Dip LSI	1SDA070832R1		1SDA071462R1	
				E1.2C 1250 Ekip Dip LSIG	1SDA070833R1		1SDA071463R1	
				E1.2C 1250 Ekip Touch LI	1SDA070834R1		1SDA071464R1	
E1.2C 1250 Ekip Touch LSI				1SDA070835R1		1SDA071465R1		
E1.2C 1250 Ekip Touch LSIG				1SDA070836R1		1SDA071466R1		
E1.2C 1250 Ekip Hi-Touch LSI				1SDA070838R1		1SDA071468R1		
E1.2C 1250 Ekip Hi-Touch LSIG				1SDA070839R1		1SDA071469R1		
1600	50	42	E1.2C 1600 Ekip Dip LI	1SDA070871R1		1SDA071501R1		
			E1.2C 1600 Ekip Dip LSI	1SDA070872R1		1SDA071502R1		
			E1.2C 1600 Ekip Dip LSIG	1SDA070873R1		1SDA071503R1		
			E1.2C 1600 Ekip Touch LI	1SDA070874R1		1SDA071504R1		
			E1.2C 1600 Ekip Touch LSI	1SDA070875R1		1SDA071505R1		
			E1.2C 1600 Ekip Touch LSIG	1SDA070876R1		1SDA071506R1		
			E1.2C 1600 Ekip Hi-Touch LSI	1SDA070878R1		1SDA071508R1		
			E1.2C 1600 Ekip Hi-Touch LSIG	1SDA070879R1		1SDA071509R1		

Automatic circuit-breakers

Fixed version for power distribution



SACE Emax E1.2N • Front terminals (F)

Size	I _u	I _{cu} (440 V)	I _{cw} (1s)	Type	3 Poles		4 Poles	
					Code		Code	
E1.2N	250	66	50	E1.2N 250 Ekip Dip LI	1SDA070691R1		1SDA071321R1	
				E1.2N 250 Ekip Dip LSI	1SDA070692R1		1SDA071322R1	
				E1.2N 250 Ekip Dip LSIG	1SDA070693R1		1SDA071323R1	
				E1.2N 250 Ekip Touch LI	1SDA070694R1		1SDA071324R1	
				E1.2N 250 Ekip Touch LSI	1SDA070695R1		1SDA071325R1	
				E1.2N 250 Ekip Touch LSIG	1SDA070696R1		1SDA071326R1	
				E1.2N 250 Ekip Hi-Touch LSI	1SDA070698R1		1SDA071328R1	
				E1.2N 250 Ekip Hi-Touch LSIG	1SDA070699R1		1SDA071329R1	
	630	66	50	E1.2N 630 Ekip Dip LI	1SDA070721R1		1SDA071351R1	
				E1.2N 630 Ekip Dip LSI	1SDA070722R1		1SDA071352R1	
				E1.2N 630 Ekip Dip LSIG	1SDA070723R1		1SDA071353R1	
				E1.2N 630 Ekip Touch LI	1SDA070724R1		1SDA071354R1	
				E1.2N 630 Ekip Touch LSI	1SDA070725R1		1SDA071355R1	
				E1.2N 630 Ekip Touch LSIG	1SDA070726R1		1SDA071356R1	
				E1.2N 630 Ekip Hi-Touch LSI	1SDA070728R1		1SDA071358R1	
				E1.2N 630 Ekip Hi-Touch LSIG	1SDA070729R1		1SDA071359R1	
	800	66	50	E1.2N 800 Ekip Dip LI	1SDA070761R1		1SDA071391R1	
				E1.2N 800 Ekip Dip LSI	1SDA070762R1		1SDA071392R1	
				E1.2N 800 Ekip Dip LSIG	1SDA070763R1		1SDA071393R1	
				E1.2N 800 Ekip Touch LI	1SDA070764R1		1SDA071394R1	
				E1.2N 800 Ekip Touch LSI	1SDA070765R1		1SDA071395R1	
				E1.2N 800 Ekip Touch LSIG	1SDA070766R1		1SDA071396R1	
				E1.2N 800 Ekip Hi-Touch LSI	1SDA070768R1		1SDA071398R1	
				E1.2N 800 Ekip Hi-Touch LSIG	1SDA070769R1		1SDA071399R1	
	1000	66	50	E1.2N 1000 Ekip Dip LI	1SDA070801R1		1SDA071431R1	
				E1.2N 1000 Ekip Dip LSI	1SDA070802R1		1SDA071432R1	
				E1.2N 1000 Ekip Dip LSIG	1SDA070803R1		1SDA071433R1	
				E1.2N 1000 Ekip Touch LI	1SDA070804R1		1SDA071434R1	
E1.2N 1000 Ekip Touch LSI				1SDA070805R1		1SDA071435R1		
E1.2N 1000 Ekip Touch LSIG				1SDA070806R1		1SDA071436R1		
E1.2N 1000 Ekip Hi-Touch LSI				1SDA070808R1		1SDA071438R1		
E1.2N 1000 Ekip Hi-Touch LSIG				1SDA070809R1		1SDA071439R1		
1250	66	50	E1.2N 1250 Ekip Dip LI	1SDA070841R1		1SDA071471R1		
			E1.2N 1250 Ekip Dip LSI	1SDA070842R1		1SDA071472R1		
			E1.2N 1250 Ekip Dip LSIG	1SDA070843R1		1SDA071473R1		
			E1.2N 1250 Ekip Touch LI	1SDA070844R1		1SDA071474R1		
			E1.2N 1250 Ekip Touch LSI	1SDA070845R1		1SDA071475R1		
			E1.2N 1250 Ekip Touch LSIG	1SDA070846R1		1SDA071476R1		
			E1.2N 1250 Ekip Hi-Touch LSI	1SDA070848R1		1SDA071478R1		
			E1.2N 1250 Ekip Hi-Touch LSIG	1SDA070849R1		1SDA071479R1		
1600	66	50	E1.2N 1600 Ekip Dip LI	1SDA070881R1		1SDA071511R1		
			E1.2N 1600 Ekip Dip LSI	1SDA070882R1		1SDA071512R1		
			E1.2N 1600 Ekip Dip LSIG	1SDA070883R1		1SDA071513R1		
			E1.2N 1600 Ekip Touch LI	1SDA070884R1		1SDA071514R1		
			E1.2N 1600 Ekip Touch LSI	1SDA070885R1		1SDA071515R1		
			E1.2N 1600 Ekip Touch LSIG	1SDA070886R1		1SDA071516R1		
			E1.2N 1600 Ekip Hi-Touch LSI	1SDA070888R1		1SDA071518R1		
			E1.2N 1600 Ekip Hi-Touch LSIG	1SDA070889R1		1SDA071519R1		



1SDC200661F001

SACE Emax E1.2L • Front terminals (F)

Size	Iu	Icu (440 V)	Icw (1s)	Type	3 Poles		4 Poles	
					Code		Code	
E1.2L	630	130	15	E1.2L 630 Ekip Dip LI	1SDA070731R1		1SDA071361R1	
				E1.2L 630 Ekip Dip LSI	1SDA070732R1		1SDA071362R1	
				E1.2L 630 Ekip Dip LSIG	1SDA070733R1		1SDA071363R1	
				E1.2L 630 Ekip Touch LI	1SDA070734R1		1SDA071364R1	
				E1.2L 630 Ekip Touch LSI	1SDA070735R1		1SDA071365R1	
				E1.2L 630 Ekip Touch LSIG	1SDA070736R1		1SDA071366R1	
				E1.2L 630 Ekip Hi-Touch LSI	1SDA070738R1		1SDA071368R1	
				E1.2L 630 Ekip Hi-Touch LSIG	1SDA070739R1		1SDA071369R1	
	800	130	15	E1.2L 800 Ekip Dip LI	1SDA070771R1		1SDA071401R1	
				E1.2L 800 Ekip Dip LSI	1SDA070772R1		1SDA071402R1	
				E1.2L 800 Ekip Dip LSIG	1SDA070773R1		1SDA071403R1	
				E1.2L 800 Ekip Touch LI	1SDA070774R1		1SDA071404R1	
				E1.2L 800 Ekip Touch LSI	1SDA070775R1		1SDA071405R1	
				E1.2L 800 Ekip Touch LSIG	1SDA070776R1		1SDA071406R1	
				E1.2L 800 Ekip Hi-Touch LSI	1SDA070778R1		1SDA071408R1	
				E1.2L 800 Ekip Hi-Touch LSIG	1SDA070779R1		1SDA071409R1	
	1000	130	15	E1.2L 1000 Ekip Dip LI	1SDA070811R1		1SDA071441R1	
				E1.2L 1000 Ekip Dip LSI	1SDA070812R1		1SDA071442R1	
				E1.2L 1000 Ekip Dip LSIG	1SDA070813R1		1SDA071443R1	
				E1.2L 1000 Ekip Touch LI	1SDA070814R1		1SDA071444R1	
				E1.2L 1000 Ekip Touch LSI	1SDA070815R1		1SDA071445R1	
				E1.2L 1000 Ekip Touch LSIG	1SDA070816R1		1SDA071446R1	
				E1.2L 1000 Ekip Hi-Touch LSI	1SDA070818R1		1SDA071448R1	
				E1.2L 1000 Ekip Hi-Touch LSIG	1SDA070819R1		1SDA071449R1	
	1250	130	15	E1.2L 1250 Ekip Dip LI	1SDA070851R1		1SDA071481R1	
				E1.2L 1250 Ekip Dip LSI	1SDA070852R1		1SDA071482R1	
				E1.2L 1250 Ekip Dip LSIG	1SDA070853R1		1SDA071483R1	
				E1.2L 1250 Ekip Touch LI	1SDA070854R1		1SDA071484R1	
E1.2L 1250 Ekip Touch LSI				1SDA070855R1		1SDA071485R1		
E1.2L 1250 Ekip Touch LSIG				1SDA070856R1		1SDA071486R1		
E1.2L 1250 Ekip Hi-Touch LSI				1SDA070858R1		1SDA071488R1		
E1.2L 1250 Ekip Hi-Touch LSIG				1SDA070859R1		1SDA071489R1		

Automatic circuit-breakers

Fixed version for power distribution



SACE Emax E2.2B • Orientable rear terminals (HR)

Size	Iu	Icu (440 V)	Icw (1s)	Type	3 Poles		4 Poles	
					Code		Code	
E2.2B	1600	42	42	E2.2B 1600 Ekip Dip LI	1SDA070981R1		1SDA071611R1	
				E2.2B 1600 Ekip Dip LSI	1SDA070982R1		1SDA071612R1	
				E2.2B 1600 Ekip Dip LSIG	1SDA070983R1		1SDA071613R1	
				E2.2B 1600 Ekip Touch LI	1SDA070984R1		1SDA071614R1	
				E2.2B 1600 Ekip Touch LSI	1SDA070985R1		1SDA071615R1	
				E2.2B 1600 Ekip Touch LSIG	1SDA070986R1		1SDA071616R1	
				E2.2B 1600 Ekip Hi-Touch LSI	1SDA070988R1		1SDA071618R1	
				E2.2B 1600 Ekip Hi-Touch LSIG	1SDA070989R1		1SDA071619R1	
	2000	42	42	E2.2B 2000 Ekip Dip LI	1SDA071021R1		1SDA071651R1	
				E2.2B 2000 Ekip Dip LSI	1SDA071022R1		1SDA071652R1	
				E2.2B 2000 Ekip Dip LSIG	1SDA071023R1		1SDA071653R1	
				E2.2B 2000 Ekip Touch LI	1SDA071024R1		1SDA071654R1	
				E2.2B 2000 Ekip Touch LSI	1SDA071025R1		1SDA071655R1	
				E2.2B 2000 Ekip Touch LSIG	1SDA071026R1		1SDA071656R1	
				E2.2B 2000 Ekip Hi-Touch LSI	1SDA071028R1		1SDA071658R1	
				E2.2B 2000 Ekip Hi-Touch LSIG	1SDA071029R1		1SDA071659R1	



1SDC20002P001

SACE Emax E2.2N • Orientable rear terminals (HR)

Size	Iu	Icu (440 V)	Icw (1s)	Type	3 Poles		4 Poles	
					Code		Code	
E2.2N	800	66	66	E2.2N 800 Ekip Dip LI	1SDA070891R1		1SDA071521R1	
				E2.2N 800 Ekip Dip LSI	1SDA070892R1		1SDA071522R1	
				E2.2N 800 Ekip Dip LSIG	1SDA070893R1		1SDA071523R1	
				E2.2N 800 Ekip Touch LI	1SDA070894R1		1SDA071524R1	
				E2.2N 800 Ekip Touch LSI	1SDA070895R1		1SDA071525R1	
				E2.2N 800 Ekip Touch LSIG	1SDA070896R1		1SDA071526R1	
				E2.2N 800 Ekip Hi-Touch LSI	1SDA070898R1		1SDA071528R1	
				E2.2N 800 Ekip Hi-Touch LSIG	1SDA070899R1		1SDA071529R1	
	1000	66	66	E2.2N 1000 Ekip Dip LI	1SDA070921R1		1SDA071551R1	
				E2.2N 1000 Ekip Dip LSI	1SDA070922R1		1SDA071552R1	
				E2.2N 1000 Ekip Dip LSIG	1SDA070923R1		1SDA071553R1	
				E2.2N 1000 Ekip Touch LI	1SDA070924R1		1SDA071554R1	
				E2.2N 1000 Ekip Touch LSI	1SDA070925R1		1SDA071555R1	
				E2.2N 1000 Ekip Touch LSIG	1SDA070926R1		1SDA071556R1	
				E2.2N 1000 Ekip Hi-Touch LSI	1SDA070928R1		1SDA071558R1	
				E2.2N 1000 Ekip Hi-Touch LSIG	1SDA070929R1		1SDA071559R1	
	1250	66	66	E2.2N 1250 Ekip Dip LI	1SDA070951R1		1SDA071581R1	
				E2.2N 1250 Ekip Dip LSI	1SDA070952R1		1SDA071582R1	
				E2.2N 1250 Ekip Dip LSIG	1SDA070953R1		1SDA071583R1	
				E2.2N 1250 Ekip Touch LI	1SDA070954R1		1SDA071584R1	
				E2.2N 1250 Ekip Touch LSI	1SDA070955R1		1SDA071585R1	
				E2.2N 1250 Ekip Touch LSIG	1SDA070956R1		1SDA071586R1	
				E2.2N 1250 Ekip Hi-Touch LSI	1SDA070958R1		1SDA071588R1	
				E2.2N 1250 Ekip Hi-Touch LSIG	1SDA070959R1		1SDA071589R1	
	1600	66	66	E2.2N 1600 Ekip Dip LI	1SDA070991R1		1SDA071621R1	
				E2.2N 1600 Ekip Dip LSI	1SDA070992R1		1SDA071622R1	
				E2.2N 1600 Ekip Dip LSIG	1SDA070993R1		1SDA071623R1	
				E2.2N 1600 Ekip Touch LI	1SDA070994R1		1SDA071624R1	
E2.2N 1600 Ekip Touch LSI				1SDA070995R1		1SDA071625R1		
E2.2N 1600 Ekip Touch LSIG				1SDA070996R1		1SDA071626R1		
E2.2N 1600 Ekip Hi-Touch LSI				1SDA070998R1		1SDA071628R1		
E2.2N 1600 Ekip Hi-Touch LSIG				1SDA070999R1		1SDA071629R1		
2000	66	66	E2.2N 2000 Ekip Dip LI	1SDA071031R1		1SDA071661R1		
			E2.2N 2000 Ekip Dip LSI	1SDA071032R1		1SDA071662R1		
			E2.2N 2000 Ekip Dip LSIG	1SDA071033R1		1SDA071663R1		
			E2.2N 2000 Ekip Touch LI	1SDA071034R1		1SDA071664R1		
			E2.2N 2000 Ekip Touch LSI	1SDA071035R1		1SDA071665R1		
			E2.2N 2000 Ekip Touch LSIG	1SDA071036R1		1SDA071666R1		
			E2.2N 2000 Ekip Hi-Touch LSI	1SDA071038R1		1SDA071668R1		
			E2.2N 2000 Ekip Hi-Touch LSIG	1SDA071039R1		1SDA071669R1		
2500	66	66	E2.2N 2500 Ekip Dip LI	1SDA071061R1		1SDA071691R1		
			E2.2N 2500 Ekip Dip LSI	1SDA071062R1		1SDA071692R1		
			E2.2N 2500 Ekip Dip LSIG	1SDA071063R1		1SDA071693R1		
			E2.2N 2500 Ekip Touch LI	1SDA071064R1		1SDA071694R1		
			E2.2N 2500 Ekip Touch LSI	1SDA071065R1		1SDA071695R1		
			E2.2N 2500 Ekip Touch LSIG	1SDA071066R1		1SDA071696R1		
			E2.2N 2500 Ekip Hi-Touch LSI	1SDA071068R1		1SDA071698R1		
			E2.2N 2500 Ekip Hi-Touch LSIG	1SDA071069R1		1SDA071699R1		

Automatic circuit-breakers

Fixed version for power distribution



1SDC200023D0203

SACE Emax E2.2S • Orientable rear terminals (HR)

Size	Iu	Icu (440 V)	Icw (1s)	Type	3 Poles		4 Poles	
					Code		Code	
E2.2S	250	85	66	E2.2S 250 Ekip Dip LI	1SDA073628R1		1SDA073638R1	
				E2.2S 250 Ekip Dip LSI	1SDA073629R1		1SDA073639R1	
				E2.2S 250 Ekip Dip LSIG	1SDA073630R1		1SDA073640R1	
				E2.2S 250 Ekip Touch LI	1SDA073631R1		1SDA073641R1	
				E2.2S 250 Ekip Touch LSI	1SDA073632R1		1SDA073642R1	
				E2.2S 250 Ekip Touch LSIG	1SDA073633R1		1SDA073643R1	
				E2.2S 250 Ekip Hi-Touch LSI	1SDA073635R1		1SDA073645R1	
				E2.2S 250 Ekip Hi-Touch LSIG	1SDA073636R1		1SDA073646R1	
	800	85	66	E2.2S 800 Ekip Dip LI	1SDA070901R1		1SDA071531R1	
				E2.2S 800 Ekip Dip LSI	1SDA070902R1		1SDA071532R1	
				E2.2S 800 Ekip Dip LSIG	1SDA070903R1		1SDA071533R1	
				E2.2S 800 Ekip Touch LI	1SDA070904R1		1SDA071534R1	
				E2.2S 800 Ekip Touch LSI	1SDA070905R1		1SDA071535R1	
				E2.2S 800 Ekip Touch LSIG	1SDA070906R1		1SDA071536R1	
				E2.2S 800 Ekip Hi-Touch LSI	1SDA070908R1		1SDA071538R1	
				E2.2S 800 Ekip Hi-Touch LSIG	1SDA070909R1		1SDA071539R1	
	1000	85	66	E2.2S 1000 Ekip Dip LI	1SDA070931R1		1SDA071561R1	
				E2.2S 1000 Ekip Dip LSI	1SDA070932R1		1SDA071562R1	
				E2.2S 1000 Ekip Dip LSIG	1SDA070933R1		1SDA071563R1	
				E2.2S 1000 Ekip Touch LI	1SDA070934R1		1SDA071564R1	
				E2.2S 1000 Ekip Touch LSI	1SDA070935R1		1SDA071565R1	
				E2.2S 1000 Ekip Touch LSIG	1SDA070936R1		1SDA071566R1	
				E2.2S 1000 Ekip Hi-Touch LSI	1SDA070938R1		1SDA071568R1	
				E2.2S 1000 Ekip Hi-Touch LSIG	1SDA070939R1		1SDA071569R1	
	1250	85	66	E2.2S 1250 Ekip Dip LI	1SDA070961R1		1SDA071591R1	
				E2.2S 1250 Ekip Dip LSI	1SDA070962R1		1SDA071592R1	
				E2.2S 1250 Ekip Dip LSIG	1SDA070963R1		1SDA071593R1	
				E2.2S 1250 Ekip Touch LI	1SDA070964R1		1SDA071594R1	
				E2.2S 1250 Ekip Touch LSI	1SDA070965R1		1SDA071595R1	
				E2.2S 1250 Ekip Touch LSIG	1SDA070966R1		1SDA071596R1	
				E2.2S 1250 Ekip Hi-Touch LSI	1SDA070968R1		1SDA071598R1	
				E2.2S 1250 Ekip Hi-Touch LSIG	1SDA070969R1		1SDA071599R1	



1SDC200023D0203

SACE Emax E2.2S • Orientable rear terminals (HR)

Size	Iu	Icu (440 V)	Icw (1s)	Type	3 Poles		4 Poles	
					Code		Code	
E2.2S	1600	85	66	E2.2S 1600 Ekip Dip LI	1SDA071001R1		1SDA071631R1	
				E2.2S 1600 Ekip Dip LSI	1SDA071002R1		1SDA071632R1	
				E2.2S 1600 Ekip Dip LSIG	1SDA071003R1		1SDA071633R1	
				E2.2S 1600 Ekip Touch LI	1SDA071004R1		1SDA071634R1	
				E2.2S 1600 Ekip Touch LSI	1SDA071005R1		1SDA071635R1	
				E2.2S 1600 Ekip Touch LSIG	1SDA071006R1		1SDA071636R1	
				E2.2S 1600 Ekip Hi-Touch LSI	1SDA071008R1		1SDA071638R1	
				E2.2S 1600 Ekip Hi-Touch LSIG	1SDA071009R1		1SDA071639R1	
	2000	85	66	E2.2S 2000 Ekip Dip LI	1SDA071041R1		1SDA071671R1	
				E2.2S 2000 Ekip Dip LSI	1SDA071042R1		1SDA071672R1	
				E2.2S 2000 Ekip Dip LSIG	1SDA071043R1		1SDA071673R1	
				E2.2S 2000 Ekip Touch LI	1SDA071044R1		1SDA071674R1	
				E2.2S 2000 Ekip Touch LSI	1SDA071045R1		1SDA071675R1	
				E2.2S 2000 Ekip Touch LSIG	1SDA071046R1		1SDA071676R1	
				E2.2S 2000 Ekip Hi-Touch LSI	1SDA071048R1		1SDA071678R1	
				E2.2S 2000 Ekip Hi-Touch LSIG	1SDA071049R1		1SDA071679R1	
	2500	85	66	E2.2S 2500 Ekip Dip LI	1SDA071071R1		1SDA071701R1	
				E2.2S 2500 Ekip Dip LSI	1SDA071072R1		1SDA071702R1	
				E2.2S 2500 Ekip Dip LSIG	1SDA071073R1		1SDA071703R1	
				E2.2S 2500 Ekip Touch LI	1SDA071074R1		1SDA071704R1	
				E2.2S 2500 Ekip Touch LSI	1SDA071075R1		1SDA071705R1	
				E2.2S 2500 Ekip Touch LSIG	1SDA071076R1		1SDA071706R1	
				E2.2S 2500 Ekip Hi-Touch LSI	1SDA071078R1		1SDA071708R1	
				E2.2S 2500 Ekip Hi-Touch LSIG	1SDA071079R1		1SDA071709R1	

Automatic circuit-breakers

Fixed version for power distribution



1SDC20002F001

SACE Emax E2.2H • Orientable rear terminals (HR)

Size	I _u	I _{cu} (440 V)	I _{cw} (1s)	Type	3 Poles		4 Poles	
					Code		Code	
E2.2H	800	100	85	E2.2H 800 Ekip Dip LI	1SDA070911R1		1SDA071541R1	
				E2.2H 800 Ekip Dip LSI	1SDA070912R1		1SDA071542R1	
				E2.2H 800 Ekip Dip LSIG	1SDA070913R1		1SDA071543R1	
				E2.2H 800 Ekip Touch LI	1SDA070914R1		1SDA071544R1	
				E2.2H 800 Ekip Touch LSI	1SDA070915R1		1SDA071545R1	
				E2.2H 800 Ekip Touch LSIG	1SDA070916R1		1SDA071546R1	
				E2.2H 800 Ekip Hi-Touch LSI	1SDA070918R1		1SDA071548R1	
				E2.2H 800 Ekip Hi-Touch LSIG	1SDA070919R1		1SDA071549R1	
	1000	100	85	E2.2H 1000 Ekip Dip LI	1SDA070941R1		1SDA071571R1	
				E2.2H 1000 Ekip Dip LSI	1SDA070942R1		1SDA071572R1	
				E2.2H 1000 Ekip Dip LSIG	1SDA070943R1		1SDA071573R1	
				E2.2H 1000 Ekip Touch LI	1SDA070944R1		1SDA071574R1	
				E2.2H 1000 Ekip Touch LSI	1SDA070945R1		1SDA071575R1	
				E2.2H 1000 Ekip Touch LSIG	1SDA070946R1		1SDA071576R1	
				E2.2H 1000 Ekip Hi-Touch LSI	1SDA070948R1		1SDA071578R1	
				E2.2H 1000 Ekip Hi-Touch LSIG	1SDA070949R1		1SDA071579R1	
	1250	100	85	E2.2H 1250 Ekip Dip LI	1SDA070971R1		1SDA071601R1	
				E2.2H 1250 Ekip Dip LSI	1SDA070972R1		1SDA071602R1	
				E2.2H 1250 Ekip Dip LSIG	1SDA070973R1		1SDA071603R1	
				E2.2H 1250 Ekip Touch LI	1SDA070974R1		1SDA071604R1	
				E2.2H 1250 Ekip Touch LSI	1SDA070975R1		1SDA071605R1	
				E2.2H 1250 Ekip Touch LSIG	1SDA070976R1		1SDA071606R1	
				E2.2H 1250 Ekip Hi-Touch LSI	1SDA070978R1		1SDA071608R1	
				E2.2H 1250 Ekip Hi-Touch LSIG	1SDA070979R1		1SDA071609R1	
	1600	100	85	E2.2H 1600 Ekip Dip LI	1SDA071011R1		1SDA071641R1	
				E2.2H 1600 Ekip Dip LSI	1SDA071012R1		1SDA071642R1	
				E2.2H 1600 Ekip Dip LSIG	1SDA071013R1		1SDA071643R1	
				E2.2H 1600 Ekip Touch LI	1SDA071014R1		1SDA071644R1	
E2.2H 1600 Ekip Touch LSI				1SDA071015R1		1SDA071645R1		
E2.2H 1600 Ekip Touch LSIG				1SDA071016R1		1SDA071646R1		
E2.2H 1600 Ekip Hi-Touch LSI				1SDA071018R1		1SDA071648R1		
E2.2H 1600 Ekip Hi-Touch LSIG				1SDA071019R1		1SDA071649R1		
2000	100	85	E2.2H 2000 Ekip Dip LI	1SDA071051R1		1SDA071681R1		
			E2.2H 2000 Ekip Dip LSI	1SDA071052R1		1SDA071682R1		
			E2.2H 2000 Ekip Dip LSIG	1SDA071053R1		1SDA071683R1		
			E2.2H 2000 Ekip Touch LI	1SDA071054R1		1SDA071684R1		
			E2.2H 2000 Ekip Touch LSI	1SDA071055R1		1SDA071685R1		
			E2.2H 2000 Ekip Touch LSIG	1SDA071056R1		1SDA071686R1		
			E2.2H 2000 Ekip Hi-Touch LSI	1SDA071058R1		1SDA071688R1		
			E2.2H 2000 Ekip Hi-Touch LSIG	1SDA071059R1		1SDA071689R1		
2500	100	85	E2.2H 2500 Ekip Dip LI	1SDA071081R1		1SDA071711R1		
			E2.2H 2500 Ekip Dip LSI	1SDA071082R1		1SDA071712R1		
			E2.2H 2500 Ekip Dip LSIG	1SDA071083R1		1SDA071713R1		
			E2.2H 2500 Ekip Touch LI	1SDA071084R1		1SDA071714R1		
			E2.2H 2500 Ekip Touch LSI	1SDA071085R1		1SDA071715R1		
			E2.2H 2500 Ekip Touch LSIG	1SDA071086R1		1SDA071716R1		
			E2.2H 2500 Ekip Hi-Touch LSI	1SDA071088R1		1SDA071718R1		
			E2.2H 2500 Ekip Hi-Touch LSIG	1SDA071089R1		1SDA071719R1		



1SDC200683R001

SACE Emax E4.2N-S • Orientable rear terminals (HR)

Size	Iu	Icu (440 V)	Icw (1s)	Type	3 Poles		4 Poles	
					Code		Code	
E4.2N	3200	66	66	E4.2N 3200 Ekip Dip LI	1SDA071141R1		1SDA071771R1	
				E4.2N 3200 Ekip Dip LSI	1SDA071142R1		1SDA071772R1	
				E4.2N 3200 Ekip Dip LSIG	1SDA071143R1		1SDA071773R1	
				E4.2N 3200 Ekip Touch LI	1SDA071144R1		1SDA071774R1	
				E4.2N 3200 Ekip Touch LSI	1SDA071145R1		1SDA071775R1	
				E4.2N 3200 Ekip Touch LSIG	1SDA071146R1		1SDA071776R1	
				E4.2N 3200 Ekip Hi-Touch LSI	1SDA071148R1		1SDA071778R1	
				E4.2N 3200 Ekip Hi-Touch LSIG	1SDA071149R1		1SDA071779R1	
	4000	66	66	E4.2N 4000 Ekip Dip LI	1SDA071191R1		1SDA071821R1	
				E4.2N 4000 Ekip Dip LSI	1SDA071192R1		1SDA071822R1	
				E4.2N 4000 Ekip Dip LSIG	1SDA071193R1		1SDA071823R1	
				E4.2N 4000 Ekip Touch LI	1SDA071194R1		1SDA071824R1	
				E4.2N 4000 Ekip Touch LSI	1SDA071195R1		1SDA071825R1	
				E4.2N 4000 Ekip Touch LSIG	1SDA071196R1		1SDA071826R1	
				E4.2N 4000 Ekip Hi-Touch LSI	1SDA071198R1		1SDA071828R1	
				E4.2N 4000 Ekip Hi-Touch LSIG	1SDA071199R1		1SDA071829R1	
E4.2S	3200	85	66	E4.2S 3200 Ekip Dip LI	1SDA071151R1		1SDA071781R1	
				E4.2S 3200 Ekip Dip LSI	1SDA071152R1		1SDA071782R1	
				E4.2S 3200 Ekip Dip LSIG	1SDA071153R1		1SDA071783R1	
				E4.2S 3200 Ekip Touch LI	1SDA071154R1		1SDA071784R1	
				E4.2S 3200 Ekip Touch LSI	1SDA071155R1		1SDA071785R1	
				E4.2S 3200 Ekip Touch LSIG	1SDA071156R1		1SDA071786R1	
				E4.2S 3200 Ekip Hi-Touch LSI	1SDA071158R1		1SDA071788R1	
				E4.2S 3200 Ekip Hi-Touch LSIG	1SDA071159R1		1SDA071789R1	
	4000	85	66	E4.2S 4000 Ekip Dip LI	1SDA071201R1		1SDA071831R1	
				E4.2S 4000 Ekip Dip LSI	1SDA071202R1		1SDA071832R1	
				E4.2S 4000 Ekip Dip LSIG	1SDA071203R1		1SDA071833R1	
				E4.2S 4000 Ekip Touch LI	1SDA071204R1		1SDA071834R1	
				E4.2S 4000 Ekip Touch LSI	1SDA071205R1		1SDA071835R1	
				E4.2S 4000 Ekip Touch LSIG	1SDA071206R1		1SDA071836R1	
				E4.2S 4000 Ekip Hi-Touch LSI	1SDA071208R1		1SDA071838R1	
				E4.2S 4000 Ekip Hi-Touch LSIG	1SDA071209R1		1SDA071839R1	

Automatic circuit-breakers

Fixed version for power distribution



1SDC20086R001

SACE Emax E4.2H-V • Orientable rear terminals (HR)

Size	I _u	I _{cu} (440 V)	I _{cw} (1s)	Type	3 Poles		4 Poles	
					Code		Code	
E4.2H	3200	100	85	E4.2H 3200 Ekip Dip LI	1SDA071161R1		1SDA071791R1	
				E4.2H 3200 Ekip Dip LSI	1SDA071162R1		1SDA071792R1	
				E4.2H 3200 Ekip Dip LSIG	1SDA071163R1		1SDA071793R1	
				E4.2H 3200 Ekip Touch LI	1SDA071164R1		1SDA071794R1	
				E4.2H 3200 Ekip Touch LSI	1SDA071165R1		1SDA071795R1	
				E4.2H 3200 Ekip Touch LSIG	1SDA071166R1		1SDA071796R1	
				E4.2H 3200 Ekip Hi-Touch LSI	1SDA071168R1		1SDA071798R1	
				E4.2H 3200 Ekip Hi-Touch LSIG	1SDA071169R1		1SDA071799R1	
	4000	100	85	E4.2H 4000 Ekip Dip LI	1SDA071211R1		1SDA071841R1	
				E4.2H 4000 Ekip Dip LSI	1SDA071212R1		1SDA071842R1	
				E4.2H 4000 Ekip Dip LSIG	1SDA071213R1		1SDA071843R1	
				E4.2H 4000 Ekip Touch LI	1SDA071214R1		1SDA071844R1	
				E4.2H 4000 Ekip Touch LSI	1SDA071215R1		1SDA071845R1	
				E4.2H 4000 Ekip Touch LSIG	1SDA071216R1		1SDA071846R1	
				E4.2H 4000 Ekip Hi-Touch LSI	1SDA071218R1		1SDA071848R1	
				E4.2H 4000 Ekip Hi-Touch LSIG	1SDA071219R1		1SDA071849R1	
E4.2V	2000	150	100	E4.2V 2000 Ekip Dip LI	1SDA071101R1		1SDA071731R1	
				E4.2V 2000 Ekip Dip LSI	1SDA071102R1		1SDA071732R1	
				E4.2V 2000 Ekip Dip LSIG	1SDA071103R1		1SDA071733R1	
				E4.2V 2000 Ekip Touch LI	1SDA071104R1		1SDA071734R1	
				E4.2V 2000 Ekip Touch LSI	1SDA071105R1		1SDA071735R1	
				E4.2V 2000 Ekip Touch LSIG	1SDA071106R1		1SDA071736R1	
				E4.2V 2000 Ekip Hi-Touch LSI	1SDA071108R1		1SDA071738R1	
				E4.2V 2000 Ekip Hi-Touch LSIG	1SDA071109R1		1SDA071739R1	
	2500	150	100	E4.2V 2500 Ekip Dip LI	1SDA071121R1		1SDA071751R1	
				E4.2V 2500 Ekip Dip LSI	1SDA071122R1		1SDA071752R1	
				E4.2V 2500 Ekip Dip LSIG	1SDA071123R1		1SDA071753R1	
				E4.2V 2500 Ekip Touch LI	1SDA071124R1		1SDA071754R1	
				E4.2V 2500 Ekip Touch LSI	1SDA071125R1		1SDA071755R1	
				E4.2V 2500 Ekip Touch LSIG	1SDA071126R1		1SDA071756R1	
				E4.2V 2500 Ekip Hi-Touch LSI	1SDA071128R1		1SDA071758R1	
				E4.2V 2500 Ekip Hi-Touch LSIG	1SDA071129R1		1SDA071759R1	
	3200	150	100	E4.2V 3200 Ekip Dip LI	1SDA071171R1		1SDA071801R1	
				E4.2V 3200 Ekip Dip LSI	1SDA071172R1		1SDA071802R1	
				E4.2V 3200 Ekip Dip LSIG	1SDA071173R1		1SDA071803R1	
				E4.2V 3200 Ekip Touch LI	1SDA071174R1		1SDA071804R1	
				E4.2V 3200 Ekip Touch LSI	1SDA071175R1		1SDA071805R1	
				E4.2V 3200 Ekip Touch LSIG	1SDA071176R1		1SDA071806R1	
				E4.2V 3200 Ekip Hi-Touch LSI	1SDA071178R1		1SDA071808R1	
				E4.2V 3200 Ekip Hi-Touch LSIG	1SDA071179R1		1SDA071809R1	
	4000	150	100	E4.2V 4000 Ekip Dip LI	1SDA071221R1		1SDA071851R1	
				E4.2V 4000 Ekip Dip LSI	1SDA071222R1		1SDA071852R1	
				E4.2V 4000 Ekip Dip LSIG	1SDA071223R1		1SDA071853R1	
				E4.2V 4000 Ekip Touch LI	1SDA071224R1		1SDA071854R1	
				E4.2V 4000 Ekip Touch LSI	1SDA071225R1		1SDA071855R1	
				E4.2V 4000 Ekip Touch LSIG	1SDA071226R1		1SDA071856R1	
				E4.2V 4000 Ekip Hi-Touch LSI	1SDA071228R1		1SDA071858R1	
				E4.2V 4000 Ekip Hi-Touch LSIG	1SDA071229R1		1SDA071859R1	



1SDC200664F001

SACE Emax E6.2H-V • Orientable rear terminals (HR)

Size	Iu	Icu (440 V)	Icw (1s)	Type	3 Poles		4 Poles					
					Code		Code					
E6.2H	4000	100	100	E6.2H 4000 Ekip Dip LI	1SDA071231R1		1SDA071861R1					
				E6.2H 4000 Ekip Dip LSI	1SDA071232R1		1SDA071862R1					
				E6.2H 4000 Ekip Dip LSIG	1SDA071233R1		1SDA071863R1					
				E6.2H 4000 Ekip Touch LI	1SDA071234R1		1SDA071864R1					
				E6.2H 4000 Ekip Touch LSI	1SDA071235R1		1SDA071865R1					
				E6.2H 4000 Ekip Touch LSIG	1SDA071236R1		1SDA071866R1					
				E6.2H 4000 Ekip Hi-Touch LSI	1SDA071238R1		1SDA071868R1					
				E6.2H 4000 Ekip Hi-Touch LSIG	1SDA071239R1		1SDA071869R1					
				5000	100	100	E6.2H 5000 Ekip Dip LI	1SDA071261R1		1SDA071891R1		
							E6.2H 5000 Ekip Dip LSI	1SDA071262R1		1SDA071892R1		
							E6.2H 5000 Ekip Dip LSIG	1SDA071263R1		1SDA071893R1		
							E6.2H 5000 Ekip Touch LI	1SDA071264R1		1SDA071894R1		
	E6.2H 5000 Ekip Touch LSI	1SDA071265R1					1SDA071895R1					
	E6.2H 5000 Ekip Touch LSIG	1SDA071266R1					1SDA071896R1					
	E6.2H 5000 Ekip Hi-Touch LSI	1SDA071268R1					1SDA071898R1					
	E6.2H 5000 Ekip Hi-Touch LSIG	1SDA071269R1					1SDA071899R1					
	6300	100	100				E6.2H 6300 Ekip Dip LI	1SDA071291R1		1SDA071921R1		
							E6.2H 6300 Ekip Dip LSI	1SDA071292R1		1SDA071922R1		
							E6.2H 6300 Ekip Dip LSIG	1SDA071293R1		1SDA071923R1		
							E6.2H 6300 Ekip Touch LI	1SDA071294R1		1SDA071924R1		
				E6.2H 6300 Ekip Touch LSI	1SDA071295R1		1SDA071925R1					
				E6.2H 6300 Ekip Touch LSIG	1SDA071296R1		1SDA071926R1					
				E6.2H 6300 Ekip Hi-Touch LSI	1SDA071298R1		1SDA071928R1					
				E6.2H 6300 Ekip Hi-Touch LSIG	1SDA071299R1		1SDA071929R1					
				E6.2V	4000	150	100	E6.2V 4000 Ekip Dip LI	1SDA071241R1		1SDA071871R1	
								E6.2V 4000 Ekip Dip LSI	1SDA071242R1		1SDA071872R1	
								E6.2V 4000 Ekip Dip LSIG	1SDA071243R1		1SDA071873R1	
								E6.2V 4000 Ekip Touch LI	1SDA071244R1		1SDA071874R1	
	E6.2V 4000 Ekip Touch LSI	1SDA071245R1						1SDA071875R1				
	E6.2V 4000 Ekip Touch LSIG	1SDA071246R1						1SDA071876R1				
	E6.2V 4000 Ekip Hi-Touch LSI	1SDA071248R1						1SDA071878R1				
	E6.2V 4000 Ekip Hi-Touch LSIG	1SDA071249R1						1SDA071879R1				
	5000	150	100					E6.2V 5000 Ekip Dip LI	1SDA071271R1		1SDA071901R1	
								E6.2V 5000 Ekip Dip LSI	1SDA071272R1		1SDA071902R1	
								E6.2V 5000 Ekip Dip LSIG	1SDA071273R1		1SDA071903R1	
								E6.2V 5000 Ekip Touch LI	1SDA071274R1		1SDA071904R1	
E6.2V 5000 Ekip Touch LSI					1SDA071275R1		1SDA071905R1					
E6.2V 5000 Ekip Touch LSIG					1SDA071276R1		1SDA071906R1					
E6.2V 5000 Ekip Hi-Touch LSI					1SDA071278R1		1SDA071908R1					
E6.2V 5000 Ekip Hi-Touch LSIG					1SDA071279R1		1SDA071909R1					
6300					150	100	E6.2V 6300 Ekip Dip LI	1SDA071301R1		1SDA071931R1		
							E6.2V 6300 Ekip Dip LSI	1SDA071302R1		1SDA071932R1		
							E6.2V 6300 Ekip Dip LSIG	1SDA071303R1		1SDA071933R1		
							E6.2V 6300 Ekip Touch LI	1SDA071304R1		1SDA071934R1		
	E6.2V 6300 Ekip Touch LSI	1SDA071305R1					1SDA071935R1					
	E6.2V 6300 Ekip Touch LSIG	1SDA071306R1					1SDA071936R1					
	E6.2V 6300 Ekip Hi-Touch LSI	1SDA071308R1					1SDA071938R1					
	E6.2V 6300 Ekip Hi-Touch LSIG	1SDA071309R1					1SDA071939R1					

Automatic circuit-breakers

Fixed version for power distribution



1SDC200023D0203

SACE Emax E6.2X • Orientable rear terminals (HR)

Size	Iu	Icu (440 V)	Icw (1s)	Type	3 Poles		4 Poles	
					Code		Code	
E6.2X	4000	200	120	E6.2X 4000 Ekip Dip LI	1SDA071251R1		1SDA071881R1	
				E6.2X 4000 Ekip Dip LSI	1SDA071252R1		1SDA071882R1	
				E6.2X 4000 Ekip Dip LSIG	1SDA071253R1		1SDA071883R1	
				E6.2X 4000 Ekip Touch LI	1SDA071254R1		1SDA071884R1	
				E6.2X 4000 Ekip Touch LSI	1SDA071255R1		1SDA071885R1	
				E6.2X 4000 Ekip Touch LSIG	1SDA071256R1		1SDA071886R1	
				E6.2X 4000 Ekip Hi-Touch LSI	1SDA071258R1		1SDA071888R1	
				E6.2X 4000 Ekip Hi-Touch LSIG	1SDA071259R1		1SDA071889R1	
	5000	200	120	E6.2X 5000 Ekip Dip LI	1SDA071281R1		1SDA071911R1	
				E6.2X 5000 Ekip Dip LSI	1SDA071282R1		1SDA071912R1	
				E6.2X 5000 Ekip Dip LSIG	1SDA071283R1		1SDA071913R1	
				E6.2X 5000 Ekip Touch LI	1SDA071284R1		1SDA071914R1	
				E6.2X 5000 Ekip Touch LSI	1SDA071285R1		1SDA071915R1	
				E6.2X 5000 Ekip Touch LSIG	1SDA071286R1		1SDA071916R1	
E6.2X 5000 Ekip Hi-Touch LSI				1SDA071288R1		1SDA071918R1		
E6.2X 5000 Ekip Hi-Touch LSIG				1SDA071289R1		1SDA071919R1		
6300	200	120	E6.2X 6300 Ekip Dip LI	1SDA071311R1		1SDA071941R1		
			E6.2X 6300 Ekip Dip LSI	1SDA071312R1		1SDA071942R1		
			E6.2X 6300 Ekip Dip LSIG	1SDA071313R1		1SDA071943R1		
			E6.2X 6300 Ekip Touch LI	1SDA071314R1		1SDA071944R1		
			E6.2X 6300 Ekip Touch LSI	1SDA071315R1		1SDA071945R1		
			E6.2X 6300 Ekip Touch LSIG	1SDA071316R1		1SDA071946R1		
			E6.2X 6300 Ekip Hi-Touch LSI	1SDA071318R1		1SDA071948R1		
			E6.2X 6300 Ekip Hi-Touch LSIG	1SDA071319R1		1SDA071949R1		



1SDC200664F001

SACE Emax E6.2H-V/f Full size • Orientable rear terminals (HR)

Size	Iu	Icu (440V)	Icw (1s)	Type	4 Poles				
					Code				
E6.2H/f	4000	100	100	E6.2H/f 4000 Ekip Dip LI	1SDA071951R1				
				E6.2H/f 4000 Ekip Dip LSI	1SDA071952R1				
				E6.2H/f 4000 Ekip Dip LSIG	1SDA071953R1				
				E6.2H/f 4000 Ekip Touch LI	1SDA071954R1				
				E6.2H/f 4000 Ekip Touch LSI	1SDA071955R1				
				E6.2H/f 4000 Ekip Touch LSIG	1SDA071956R1				
				E6.2H/f 4000 Ekip Hi-Touch LSI	1SDA071958R1				
				E6.2H/f 4000 Ekip Hi-Touch LSIG	1SDA071959R1				
				5000	100	100	E6.2H/f 5000 Ekip Dip LI	1SDA071981R1	
							E6.2H/f 5000 Ekip Dip LSI	1SDA071982R1	
							E6.2H/f 5000 Ekip Dip LSIG	1SDA071983R1	
							E6.2H/f 5000 Ekip Touch LI	1SDA071984R1	
	E6.2H/f 5000 Ekip Touch LSI	1SDA071985R1							
	E6.2H/f 5000 Ekip Touch LSIG	1SDA071986R1							
	E6.2H/f 5000 Ekip Hi-Touch LSI	1SDA071988R1							
	E6.2H/f 5000 Ekip Hi-Touch LSIG	1SDA071989R1							
	6300	100	100				E6.2H/f 6300 Ekip Dip LI	1SDA072011R1	
							E6.2H/f 6300 Ekip Dip LSI	1SDA072012R1	
							E6.2H/f 6300 Ekip Dip LSIG	1SDA072013R1	
							E6.2H/f 6300 Ekip Touch LI	1SDA072014R1	
				E6.2H/f 6300 Ekip Touch LSI	1SDA072015R1				
				E6.2H/f 6300 Ekip Touch LSIG	1SDA072016R1				
				E6.2H/f 6300 Ekip Hi-Touch LSI	1SDA072018R1				
				E6.2H/f 6300 Ekip Hi-Touch LSIG	1SDA072019R1				
E6.2V/f				4000	150	100	E6.2V/f 4000 Ekip Dip LI	1SDA071961R1	
							E6.2V/f 4000 Ekip Dip LSI	1SDA071962R1	
							E6.2V/f 4000 Ekip Dip LSIG	1SDA071963R1	
							E6.2V/f 4000 Ekip Touch LI	1SDA071964R1	
	E6.2V/f 4000 Ekip Touch LSI	1SDA071965R1							
	E6.2V/f 4000 Ekip Touch LSIG	1SDA071966R1							
	E6.2V/f 4000 Ekip Hi-Touch LSI	1SDA071968R1							
	E6.2V/f 4000 Ekip Hi-Touch LSIG	1SDA071969R1							
	5000	150	100				E6.2V/f 5000 Ekip Dip LI	1SDA071991R1	
							E6.2V/f 5000 Ekip Dip LSI	1SDA071992R1	
							E6.2V/f 5000 Ekip Dip LSIG	1SDA071993R1	
							E6.2V/f 5000 Ekip Touch LI	1SDA071994R1	
				E6.2V/f 5000 Ekip Touch LSI	1SDA071995R1				
				E6.2V/f 5000 Ekip Touch LSIG	1SDA071996R1				
				E6.2V/f 5000 Ekip Hi-Touch LSI	1SDA071998R1				
				E6.2V/f 5000 Ekip Hi-Touch LSIG	1SDA071999R1				
				6300	150	100	E6.2V/f 6300 Ekip Dip LI	1SDA072021R1	
							E6.2V/f 6300 Ekip Dip LSI	1SDA072022R1	
							E6.2V/f 6300 Ekip Dip LSIG	1SDA072023R1	
							E6.2V/f 6300 Ekip Touch LI	1SDA072024R1	
	E6.2V/f 6300 Ekip Touch LSI	1SDA072025R1							
	E6.2V/f 6300 Ekip Touch LSIG	1SDA072026R1							
	E6.2V/f 6300 Ekip Hi-Touch LSI	1SDA072028R1							
	E6.2V/f 6300 Ekip Hi-Touch LSIG	1SDA072029R1							

Automatic circuit-breakers

Fixed version for power distribution



1SDC20084F001

SACE Emax E6.2X/f Full size • Orientable rear terminals (HR)

Size	Iu	Icu (440V)	Icw (1s)	Type	4 Poles Code
E6.2X/f	4000	200	120	E6.2X/f 4000 Ekip Dip LI	1SDA071971R1
				E6.2X/f 4000 Ekip Dip LSI	1SDA071972R1
				E6.2X/f 4000 Ekip Dip LSIG	1SDA071973R1
				E6.2X/f 4000 Ekip Touch LI	1SDA071974R1
				E6.2X/f 4000 Ekip Touch LSI	1SDA071975R1
				E6.2X/f 4000 Ekip Touch LSIG	1SDA071976R1
				E6.2X/f 4000 Ekip Hi-Touch LSI	1SDA071978R1
				E6.2X/f 4000 Ekip Hi-Touch LSIG	1SDA071979R1
	5000	200	120	E6.2X/f 5000 Ekip Dip LI	1SDA072001R1
				E6.2X/f 5000 Ekip Dip LSI	1SDA072002R1
				E6.2X/f 5000 Ekip Dip LSIG	1SDA072003R1
				E6.2X/f 5000 Ekip Touch LI	1SDA072004R1
				E6.2X/f 5000 Ekip Touch LSI	1SDA072005R1
				E6.2X/f 5000 Ekip Touch LSIG	1SDA072006R1
				E6.2X/f 5000 Ekip Hi-Touch LSI	1SDA072008R1
				E6.2X/f 5000 Ekip Hi-Touch LSIG	1SDA072009R1
	6300	200	120	E6.2X/f 6300 Ekip Dip LI	1SDA072031R1
				E6.2X/f 6300 Ekip Dip LSI	1SDA072032R1
				E6.2X/f 6300 Ekip Dip LSIG	1SDA072033R1
				E6.2X/f 6300 Ekip Touch LI	1SDA072034R1
				E6.2X/f 6300 Ekip Touch LSI	1SDA072035R1
				E6.2X/f 6300 Ekip Touch LSIG	1SDA072036R1
				E6.2X/f 6300 Ekip Hi-Touch LSI	1SDA072038R1
				E6.2X/f 6300 Ekip Hi-Touch LSIG	1SDA072039R1

Automatic circuit-breakers

Withdrawable version for power distribution



SACE Emax E1.2B • Mobile part of withdrawable circuit-breaker (MP)

Size	Iu	Icu (440 V)	Icw (1s)	Type	3 Poles		4 Poles	
					Code		Code	
E1.2B	630	42	42	E1.2B 630 Ekip Dip LI	1SDA072051R1		1SDA072681R1	
				E1.2B 630 Ekip Dip LSI	1SDA072052R1		1SDA072682R1	
				E1.2B 630 Ekip Dip LSIG	1SDA072053R1		1SDA072683R1	
				E1.2B 630 Ekip Touch LI	1SDA072054R1		1SDA072684R1	
				E1.2B 630 Ekip Touch LSI	1SDA072055R1		1SDA072685R1	
				E1.2B 630 Ekip Touch LSIG	1SDA072056R1		1SDA072686R1	
				E1.2B 630 Ekip Hi-Touch LSI	1SDA072058R1		1SDA072688R1	
				E1.2B 630 Ekip Hi-Touch LSIG	1SDA072059R1		1SDA072689R1	
	800	42	42	E1.2B 800 Ekip Dip LI	1SDA072091R1		1SDA072721R1	
				E1.2B 800 Ekip Dip LSI	1SDA072092R1		1SDA072722R1	
				E1.2B 800 Ekip Dip LSIG	1SDA072093R1		1SDA072723R1	
				E1.2B 800 Ekip Touch LI	1SDA072094R1		1SDA072724R1	
				E1.2B 800 Ekip Touch LSI	1SDA072095R1		1SDA072725R1	
				E1.2B 800 Ekip Touch LSIG	1SDA072096R1		1SDA072726R1	
				E1.2B 800 Ekip Hi-Touch LSI	1SDA072098R1		1SDA072728R1	
				E1.2B 800 Ekip Hi-Touch LSIG	1SDA072099R1		1SDA072729R1	
1000	42	42	E1.2B 1000 Ekip Dip LI	1SDA072131R1		1SDA072761R1		
			E1.2B 1000 Ekip Dip LSI	1SDA072132R1		1SDA072762R1		
			E1.2B 1000 Ekip Dip LSIG	1SDA072133R1		1SDA072763R1		
			E1.2B 1000 Ekip Touch LI	1SDA072134R1		1SDA072764R1		
			E1.2B 1000 Ekip Touch LSI	1SDA072135R1		1SDA072765R1		
			E1.2B 1000 Ekip Touch LSIG	1SDA072136R1		1SDA072766R1		
			E1.2B 1000 Ekip Hi-Touch LSI	1SDA072138R1		1SDA072768R1		
			E1.2B 1000 Ekip Hi-Touch LSIG	1SDA072139R1		1SDA072769R1		
1250	42	42	E1.2B 1250 Ekip Dip LI	1SDA072171R1		1SDA072801R1		
			E1.2B 1250 Ekip Dip LSI	1SDA072172R1		1SDA072802R1		
			E1.2B 1250 Ekip Dip LSIG	1SDA072173R1		1SDA072803R1		
			E1.2B 1250 Ekip Touch LI	1SDA072174R1		1SDA072804R1		
			E1.2B 1250 Ekip Touch LSI	1SDA072175R1		1SDA072805R1		
			E1.2B 1250 Ekip Touch LSIG	1SDA072176R1		1SDA072806R1		
			E1.2B 1250 Ekip Hi-Touch LSI	1SDA072178R1		1SDA072808R1		
			E1.2B 1250 Ekip Hi-Touch LSIG	1SDA072179R1		1SDA072809R1		
1600	42	42	E1.2B 1600 Ekip Dip LI	1SDA072211R1		1SDA072841R1		
			E1.2B 1600 Ekip Dip LSI	1SDA072212R1		1SDA072842R1		
			E1.2B 1600 Ekip Dip LSIG	1SDA072213R1		1SDA072843R1		
			E1.2B 1600 Ekip Touch LI	1SDA072214R1		1SDA072844R1		
			E1.2B 1600 Ekip Touch LSI	1SDA072215R1		1SDA072845R1		
			E1.2B 1600 Ekip Touch LSIG	1SDA072216R1		1SDA072846R1		
			E1.2B 1600 Ekip Hi-Touch LSI	1SDA072218R1		1SDA072848R1		
			E1.2B 1600 Ekip Hi-Touch LSIG	1SDA072219R1		1SDA072849R1		

Automatic circuit-breakers

Withdrawable version for power distribution



SACE Emax E1.2C • Mobile part of withdrawable circuit-breaker (MP)

Size	Iu	Icu (440 V)	Icw (1s)	Type	3 Poles		4 Poles	
					Code		Code	
E1.2C	630	50	42	E1.2C 630 Ekip Dip LI	1SDA072061R1		1SDA072691R1	
				E1.2C 630 Ekip Dip LSI	1SDA072062R1		1SDA072692R1	
				E1.2C 630 Ekip Dip LSIG	1SDA072063R1		1SDA072693R1	
				E1.2C 630 Ekip Touch LI	1SDA072064R1		1SDA072694R1	
				E1.2C 630 Ekip Touch LSI	1SDA072065R1		1SDA072695R1	
				E1.2C 630 Ekip Touch LSIG	1SDA072066R1		1SDA072696R1	
				E1.2C 630 Ekip Hi-Touch LSI	1SDA072068R1		1SDA072698R1	
				E1.2C 630 Ekip Hi-Touch LSIG	1SDA072069R1		1SDA072699R1	
	800	50	42	E1.2C 800 Ekip Dip LI	1SDA072101R1		1SDA072731R1	
				E1.2C 800 Ekip Dip LSI	1SDA072102R1		1SDA072732R1	
				E1.2C 800 Ekip Dip LSIG	1SDA072103R1		1SDA072733R1	
				E1.2C 800 Ekip Touch LI	1SDA072104R1		1SDA072734R1	
				E1.2C 800 Ekip Touch LSI	1SDA072105R1		1SDA072735R1	
				E1.2C 800 Ekip Touch LSIG	1SDA072106R1		1SDA072736R1	
E1.2C 800 Ekip Hi-Touch LSI				1SDA072108R1		1SDA072738R1		
E1.2C 800 Ekip Hi-Touch LSIG				1SDA072109R1		1SDA072739R1		
1000	50	42	E1.2C 1000 Ekip Dip LI	1SDA072141R1		1SDA072771R1		
			E1.2C 1000 Ekip Dip LSI	1SDA072142R1		1SDA072772R1		
			E1.2C 1000 Ekip Dip LSIG	1SDA072143R1		1SDA072773R1		
			E1.2C 1000 Ekip Touch LI	1SDA072144R1		1SDA072774R1		
			E1.2C 1000 Ekip Touch LSI	1SDA072145R1		1SDA072775R1		
			E1.2C 1000 Ekip Touch LSIG	1SDA072146R1		1SDA072776R1		
			E1.2C 1000 Ekip Hi-Touch LSI	1SDA072148R1		1SDA072778R1		
			E1.2C 1000 Ekip Hi-Touch LSIG	1SDA072149R1		1SDA072779R1		
1250	50	42	E1.2C 1250 Ekip Dip LI	1SDA072181R1		1SDA072811R1		
			E1.2C 1250 Ekip Dip LSI	1SDA072182R1		1SDA072812R1		
			E1.2C 1250 Ekip Dip LSIG	1SDA072183R1		1SDA072813R1		
			E1.2C 1250 Ekip Touch LI	1SDA072184R1		1SDA072814R1		
			E1.2C 1250 Ekip Touch LSI	1SDA072185R1		1SDA072815R1		
			E1.2C 1250 Ekip Touch LSIG	1SDA072186R1		1SDA072816R1		
			E1.2C 1250 Ekip Hi-Touch LSI	1SDA072188R1		1SDA072818R1		
			E1.2C 1250 Ekip Hi-Touch LSIG	1SDA072189R1		1SDA072819R1		
1600	50	42	E1.2C 1600 Ekip Dip LI	1SDA072221R1		1SDA072851R1		
			E1.2C 1600 Ekip Dip LSI	1SDA072222R1		1SDA072852R1		
			E1.2C 1600 Ekip Dip LSIG	1SDA072223R1		1SDA072853R1		
			E1.2C 1600 Ekip Touch LI	1SDA072224R1		1SDA072854R1		
			E1.2C 1600 Ekip Touch LSI	1SDA072225R1		1SDA072855R1		
			E1.2C 1600 Ekip Touch LSIG	1SDA072226R1		1SDA072856R1		
			E1.2C 1600 Ekip Hi-Touch LSI	1SDA072228R1		1SDA072858R1		
			E1.2C 1600 Ekip Hi-Touch LSIG	1SDA072229R1		1SDA072859R1		



SACE Emax E1.2N • Mobile part of withdrawable circuit-breaker (MP)

Size	Iu	Icu (440 V)	Icw (1s)	Type	3 Poles		4 Poles	
					Code		Code	
E1.2N	250	66	50	E1.2N 250 Ekip Dip LI	1SDA072041R1		1SDA072671R1	
				E1.2N 250 Ekip Dip LSI	1SDA072042R1		1SDA072672R1	
				E1.2N 250 Ekip Dip LSIG	1SDA072043R1		1SDA072673R1	
				E1.2N 250 Ekip Touch LI	1SDA072044R1		1SDA072674R1	
				E1.2N 250 Ekip Touch LSI	1SDA072045R1		1SDA072675R1	
				E1.2N 250 Ekip Touch LSIG	1SDA072046R1		1SDA072676R1	
				E1.2N 250 Ekip Hi-Touch LSI	1SDA072048R1		1SDA072678R1	
				E1.2N 250 Ekip Hi-Touch LSIG	1SDA072049R1		1SDA072679R1	
	630	66	50	E1.2N 630 Ekip Dip LI	1SDA072071R1		1SDA072701R1	
				E1.2N 630 Ekip Dip LSI	1SDA072072R1		1SDA072702R1	
				E1.2N 630 Ekip Dip LSIG	1SDA072073R1		1SDA072703R1	
				E1.2N 630 Ekip Touch LI	1SDA072074R1		1SDA072704R1	
				E1.2N 630 Ekip Touch LSI	1SDA072075R1		1SDA072705R1	
				E1.2N 630 Ekip Touch LSIG	1SDA072076R1		1SDA072706R1	
				E1.2N 630 Ekip Hi-Touch LSI	1SDA072078R1		1SDA072708R1	
				E1.2N 630 Ekip Hi-Touch LSIG	1SDA072079R1		1SDA072709R1	
	800	66	50	E1.2N 800 Ekip Dip LI	1SDA072111R1		1SDA072741R1	
				E1.2N 800 Ekip Dip LSI	1SDA072112R1		1SDA072742R1	
				E1.2N 800 Ekip Dip LSIG	1SDA072113R1		1SDA072743R1	
				E1.2N 800 Ekip Touch LI	1SDA072114R1		1SDA072744R1	
				E1.2N 800 Ekip Touch LSI	1SDA072115R1		1SDA072745R1	
				E1.2N 800 Ekip Touch LSIG	1SDA072116R1		1SDA072746R1	
				E1.2N 800 Ekip Hi-Touch LSI	1SDA072118R1		1SDA072748R1	
				E1.2N 800 Ekip Hi-Touch LSIG	1SDA072119R1		1SDA072749R1	
	1000	66	50	E1.2N 1000 Ekip Dip LI	1SDA072151R1		1SDA072781R1	
				E1.2N 1000 Ekip Dip LSI	1SDA072152R1		1SDA072782R1	
				E1.2N 1000 Ekip Dip LSIG	1SDA072153R1		1SDA072783R1	
				E1.2N 1000 Ekip Touch LI	1SDA072154R1		1SDA072784R1	
				E1.2N 1000 Ekip Touch LSI	1SDA072155R1		1SDA072785R1	
				E1.2N 1000 Ekip Touch LSIG	1SDA072156R1		1SDA072786R1	
				E1.2N 1000 Ekip Hi-Touch LSI	1SDA072158R1		1SDA072788R1	
				E1.2N 1000 Ekip Hi-Touch LSIG	1SDA072159R1		1SDA072789R1	
	1250	66	50	E1.2N 1250 Ekip Dip LI	1SDA072191R1		1SDA072821R1	
				E1.2N 1250 Ekip Dip LSI	1SDA072192R1		1SDA072822R1	
				E1.2N 1250 Ekip Dip LSIG	1SDA072193R1		1SDA072823R1	
				E1.2N 1250 Ekip Touch LI	1SDA072194R1		1SDA072824R1	
				E1.2N 1250 Ekip Touch LSI	1SDA072195R1		1SDA072825R1	
				E1.2N 1250 Ekip Touch LSIG	1SDA072196R1		1SDA072826R1	
				E1.2N 1250 Ekip Hi-Touch LSI	1SDA072198R1		1SDA072828R1	
				E1.2N 1250 Ekip Hi-Touch LSIG	1SDA072199R1		1SDA072829R1	
	1600	66	50	E1.2N 1600 Ekip Dip LI	1SDA072231R1		1SDA072861R1	
				E1.2N 1600 Ekip Dip LSI	1SDA072232R1		1SDA072862R1	
				E1.2N 1600 Ekip Dip LSIG	1SDA072233R1		1SDA072863R1	
				E1.2N 1600 Ekip Touch LI	1SDA072234R1		1SDA072864R1	
				E1.2N 1600 Ekip Touch LSI	1SDA072235R1		1SDA072865R1	
				E1.2N 1600 Ekip Touch LSIG	1SDA072236R1		1SDA072866R1	
				E1.2N 1600 Ekip Hi-Touch LSI	1SDA072238R1		1SDA072868R1	
				E1.2N 1600 Ekip Hi-Touch LSIG	1SDA072239R1		1SDA072869R1	

Automatic circuit-breakers

Withdrawable version for power distribution



SACE Emax E1.2L-B • Mobile part of withdrawable circuit-breaker (MP)

Size	Iu	Icu (440 V)	Icw (1s)	Type	3 Poles		4 Poles	
					Code		Code	
E1.2L	630	130	15	E1.2L 630 Ekip Dip LI	1SDA072081R1		1SDA072711R1	
				E1.2L 630 Ekip Dip LSI	1SDA072082R1		1SDA072712R1	
				E1.2L 630 Ekip Dip LSIG	1SDA072083R1		1SDA072713R1	
				E1.2L 630 Ekip Touch LI	1SDA072084R1		1SDA072714R1	
				E1.2L 630 Ekip Touch LSI	1SDA072085R1		1SDA072715R1	
				E1.2L 630 Ekip Touch LSIG	1SDA072086R1		1SDA072716R1	
				E1.2L 630 Ekip Hi-Touch LSI	1SDA072088R1		1SDA072718R1	
				E1.2L 630 Ekip Hi-Touch LSIG	1SDA072089R1		1SDA072719R1	
	800	130	15	E1.2L 800 Ekip Dip LI	1SDA072121R1		1SDA072751R1	
				E1.2L 800 Ekip Dip LSI	1SDA072122R1		1SDA072752R1	
				E1.2L 800 Ekip Dip LSIG	1SDA072123R1		1SDA072753R1	
				E1.2L 800 Ekip Touch LI	1SDA072124R1		1SDA072754R1	
				E1.2L 800 Ekip Touch LSI	1SDA072125R1		1SDA072755R1	
				E1.2L 800 Ekip Touch LSIG	1SDA072126R1		1SDA072756R1	
				E1.2L 800 Ekip Hi-Touch LSI	1SDA072128R1		1SDA072758R1	
				E1.2L 800 Ekip Hi-Touch LSIG	1SDA072129R1		1SDA072759R1	
	1000	130	15	E1.2L 1000 Ekip Dip LI	1SDA072161R1		1SDA072791R1	
				E1.2L 1000 Ekip Dip LSI	1SDA072162R1		1SDA072792R1	
				E1.2L 1000 Ekip Dip LSIG	1SDA072163R1		1SDA072793R1	
				E1.2L 1000 Ekip Touch LI	1SDA072164R1		1SDA072794R1	
				E1.2L 1000 Ekip Touch LSI	1SDA072165R1		1SDA072795R1	
				E1.2L 1000 Ekip Touch LSIG	1SDA072166R1		1SDA072796R1	
				E1.2L 1000 Ekip Hi-Touch LSI	1SDA072168R1		1SDA072798R1	
				E1.2L 1000 Ekip Hi-Touch LSIG	1SDA072169R1		1SDA072799R1	
	1250	130	15	E1.2L 1250 Ekip Dip LI	1SDA072201R1		1SDA072831R1	
				E1.2L 1250 Ekip Dip LSI	1SDA072202R1		1SDA072832R1	
				E1.2L 1250 Ekip Dip LSIG	1SDA072203R1		1SDA072833R1	
				E1.2L 1250 Ekip Touch LI	1SDA072204R1		1SDA072834R1	
E1.2L 1250 Ekip Touch LSI				1SDA072205R1		1SDA072835R1		
E1.2L 1250 Ekip Touch LSIG				1SDA072206R1		1SDA072836R1		
E1.2L 1250 Ekip Hi-Touch LSI				1SDA072208R1		1SDA072838R1		
E1.2L 1250 Ekip Hi-Touch LSIG				1SDA072209R1		1SDA072839R1		
E2.2B	1600	42	42	E2.2B 1600 Ekip Dip LI	1SDA072331R1		1SDA072961R1	
				E2.2B 1600 Ekip Dip LSI	1SDA072332R1		1SDA072962R1	
				E2.2B 1600 Ekip Dip LSIG	1SDA072333R1		1SDA072963R1	
				E2.2B 1600 Ekip Touch LI	1SDA072334R1		1SDA072964R1	
				E2.2B 1600 Ekip Touch LSI	1SDA072335R1		1SDA072965R1	
				E2.2B 1600 Ekip Touch LSIG	1SDA072336R1		1SDA072966R1	
				E2.2B 1600 Ekip Hi-Touch LSI	1SDA072338R1		1SDA072968R1	
				E2.2B 1600 Ekip Hi-Touch LSIG	1SDA072339R1		1SDA072969R1	
	2000	42	42	E2.2B 2000 Ekip Dip LI	1SDA072371R1		1SDA073001R1	
				E2.2B 2000 Ekip Dip LSI	1SDA072372R1		1SDA073002R1	
				E2.2B 2000 Ekip Dip LSIG	1SDA072373R1		1SDA073003R1	
				E2.2B 2000 Ekip Touch LI	1SDA072374R1		1SDA073004R1	
				E2.2B 2000 Ekip Touch LSI	1SDA072375R1		1SDA073005R1	
				E2.2B 2000 Ekip Touch LSIG	1SDA072376R1		1SDA073006R1	
				E2.2B 2000 Ekip Hi-Touch LSI	1SDA072378R1		1SDA073008R1	
				E2.2B 2000 Ekip Hi-Touch LSIG	1SDA072379R1		1SDA073009R1	



1SDC2000666F001

SACE Emax E2.2N • Mobile part of withdrawable circuit-breaker (MP)

Size	Iu	Icu (440 V)	Icw (1s)	Type	3 Poles		4 Poles	
					Code		Code	
E2.2N	800	66	66	E2.2N 800 Ekip Dip LI	1SDA072241R1		1SDA072871R1	
				E2.2N 800 Ekip Dip LSI	1SDA072242R1		1SDA072872R1	
				E2.2N 800 Ekip Dip LSIG	1SDA072243R1		1SDA072873R1	
				E2.2N 800 Ekip Touch LI	1SDA072244R1		1SDA072874R1	
				E2.2N 800 Ekip Touch LSI	1SDA072245R1		1SDA072875R1	
				E2.2N 800 Ekip Touch LSIG	1SDA072246R1		1SDA072876R1	
				E2.2N 800 Ekip Hi-Touch LSI	1SDA072248R1		1SDA072878R1	
				E2.2N 800 Ekip Hi-Touch LSIG	1SDA072249R1		1SDA072879R1	
	1000	66	66	E2.2N 1000 Ekip Dip LI	1SDA072271R1		1SDA072901R1	
				E2.2N 1000 Ekip Dip LSI	1SDA072272R1		1SDA072902R1	
				E2.2N 1000 Ekip Dip LSIG	1SDA072273R1		1SDA072903R1	
				E2.2N 1000 Ekip Touch LI	1SDA072274R1		1SDA072904R1	
				E2.2N 1000 Ekip Touch LSI	1SDA072275R1		1SDA072905R1	
				E2.2N 1000 Ekip Touch LSIG	1SDA072276R1		1SDA072906R1	
				E2.2N 1000 Ekip Hi-Touch LSI	1SDA072278R1		1SDA072908R1	
				E2.2N 1000 Ekip Hi-Touch LSIG	1SDA072279R1		1SDA072909R1	
	1250	66	66	E2.2N 1250 Ekip Dip LI	1SDA072301R1		1SDA072931R1	
				E2.2N 1250 Ekip Dip LSI	1SDA072302R1		1SDA072932R1	
				E2.2N 1250 Ekip Dip LSIG	1SDA072303R1		1SDA072933R1	
				E2.2N 1250 Ekip Touch LI	1SDA072304R1		1SDA072934R1	
				E2.2N 1250 Ekip Touch LSI	1SDA072305R1		1SDA072935R1	
				E2.2N 1250 Ekip Touch LSIG	1SDA072306R1		1SDA072936R1	
				E2.2N 1250 Ekip Hi-Touch LSI	1SDA072308R1		1SDA072938R1	
				E2.2N 1250 Ekip Hi-Touch LSIG	1SDA072309R1		1SDA072939R1	
	1600	66	66	E2.2N 1600 Ekip Dip LI	1SDA072341R1		1SDA072971R1	
				E2.2N 1600 Ekip Dip LSI	1SDA072342R1		1SDA072972R1	
				E2.2N 1600 Ekip Dip LSIG	1SDA072343R1		1SDA072973R1	
				E2.2N 1600 Ekip Touch LI	1SDA072344R1		1SDA072974R1	
E2.2N 1600 Ekip Touch LSI				1SDA072345R1		1SDA072975R1		
E2.2N 1600 Ekip Touch LSIG				1SDA072346R1		1SDA072976R1		
E2.2N 1600 Ekip Hi-Touch LSI				1SDA072348R1		1SDA072978R1		
E2.2N 1600 Ekip Hi-Touch LSIG				1SDA072349R1		1SDA072979R1		
2000	66	66	E2.2N 2000 Ekip Dip LI	1SDA072381R1		1SDA073011R1		
			E2.2N 2000 Ekip Dip LSI	1SDA072382R1		1SDA073012R1		
			E2.2N 2000 Ekip Dip LSIG	1SDA072383R1		1SDA073013R1		
			E2.2N 2000 Ekip Touch LI	1SDA072384R1		1SDA073014R1		
			E2.2N 2000 Ekip Touch LSI	1SDA072385R1		1SDA073015R1		
			E2.2N 2000 Ekip Touch LSIG	1SDA072386R1		1SDA073016R1		
			E2.2N 2000 Ekip Hi-Touch LSI	1SDA072388R1		1SDA073018R1		
			E2.2N 2000 Ekip Hi-Touch LSIG	1SDA072389R1		1SDA073019R1		
2500	66	66	E2.2N 2500 Ekip Dip LI	1SDA072411R1		1SDA073041R1		
			E2.2N 2500 Ekip Dip LSI	1SDA072412R1		1SDA073042R1		
			E2.2N 2500 Ekip Dip LSIG	1SDA072413R1		1SDA073043R1		
			E2.2N 2500 Ekip Touch LI	1SDA072414R1		1SDA073044R1		
			E2.2N 2500 Ekip Touch LSI	1SDA072415R1		1SDA073045R1		
			E2.2N 2500 Ekip Touch LSIG	1SDA072416R1		1SDA073046R1		
			E2.2N 2500 Ekip Hi-Touch LSI	1SDA072418R1		1SDA073048R1		
			E2.2N 2500 Ekip Hi-Touch LSIG	1SDA072419R1		1SDA073049R1		

Automatic circuit-breakers

Withdrawable version for power distribution



1SDC200023D0203

SACE Emax E2.2S • Mobile part of withdrawable circuit-breaker (MP)

Size	Iu	Icu (440 V)	Icw (1s)	Type	3 Poles		4 Poles	
					Code		Code	
E2.2S	250	85	66	E2.2S 250 Ekip Dip LI	1SDA073648R1		1SDA073658R1	
				E2.2S 250 Ekip Dip LSI	1SDA073649R1		1SDA073659R1	
				E2.2S 250 Ekip Dip LSIG	1SDA073650R1		1SDA073660R1	
				E2.2S 250 Ekip Touch LI	1SDA073651R1		1SDA073661R1	
				E2.2S 250 Ekip Touch LSI	1SDA073652R1		1SDA073662R1	
				E2.2S 250 Ekip Touch LSIG	1SDA073653R1		1SDA073663R1	
				E2.2S 250 Ekip Hi-Touch LSI	1SDA073655R1		1SDA073665R1	
				E2.2S 250 Ekip Hi-Touch LSIG	1SDA073656R1		1SDA073666R1	
	800	85	66	E2.2S 800 Ekip Dip LI	1SDA072251R1		1SDA072881R1	
				E2.2S 800 Ekip Dip LSI	1SDA072252R1		1SDA072882R1	
				E2.2S 800 Ekip Dip LSIG	1SDA072253R1		1SDA072883R1	
				E2.2S 800 Ekip Touch LI	1SDA072254R1		1SDA072884R1	
				E2.2S 800 Ekip Touch LSI	1SDA072255R1		1SDA072885R1	
				E2.2S 800 Ekip Touch LSIG	1SDA072256R1		1SDA072886R1	
				E2.2S 800 Ekip Hi-Touch LSI	1SDA072258R1		1SDA072888R1	
				E2.2S 800 Ekip Hi-Touch LSIG	1SDA072259R1		1SDA072889R1	
	1000	85	66	E2.2S 1000 Ekip Dip LI	1SDA072281R1		1SDA072911R1	
				E2.2S 1000 Ekip Dip LSI	1SDA072282R1		1SDA072912R1	
				E2.2S 1000 Ekip Dip LSIG	1SDA072283R1		1SDA072913R1	
				E2.2S 1000 Ekip Touch LI	1SDA072284R1		1SDA072914R1	
				E2.2S 1000 Ekip Touch LSI	1SDA072285R1		1SDA072915R1	
				E2.2S 1000 Ekip Touch LSIG	1SDA072286R1		1SDA072916R1	
				E2.2S 1000 Ekip Hi-Touch LSI	1SDA072288R1		1SDA072918R1	
				E2.2S 1000 Ekip Hi-Touch LSIG	1SDA072289R1		1SDA072919R1	
	1250	85	66	E2.2S 1250 Ekip Dip LI	1SDA072311R1		1SDA072941R1	
				E2.2S 1250 Ekip Dip LSI	1SDA072312R1		1SDA072942R1	
				E2.2S 1250 Ekip Dip LSIG	1SDA072313R1		1SDA072943R1	
				E2.2S 1250 Ekip Touch LI	1SDA072314R1		1SDA072944R1	
E2.2S 1250 Ekip Touch LSI				1SDA072315R1		1SDA072945R1		
E2.2S 1250 Ekip Touch LSIG				1SDA072316R1		1SDA072946R1		
E2.2S 1250 Ekip Hi-Touch LSI				1SDA072318R1		1SDA072948R1		
E2.2S 1250 Ekip Hi-Touch LSIG				1SDA072319R1		1SDA072949R1		



1SDC200066FF001

SACE Emax E2.2S • Mobile part of withdrawable circuit-breaker (MP)

Size	Iu	Icu (440 V)	Icw (1s)	Type	3 Poles	4 Poles
					Code	Code
E2.2S	1600	85	66	E2.2S 1600 Ekip Dip LI	1SDA072351R1	1SDA072981R1
				E2.2S 1600 Ekip Dip LSI	1SDA072352R1	1SDA072982R1
				E2.2S 1600 Ekip Dip LSIG	1SDA072353R1	1SDA072983R1
				E2.2S 1600 Ekip Touch LI	1SDA072354R1	1SDA072984R1
				E2.2S 1600 Ekip Touch LSI	1SDA072355R1	1SDA072985R1
				E2.2S 1600 Ekip Touch LSIG	1SDA072356R1	1SDA072986R1
				E2.2S 1600 Ekip Hi-Touch LSI	1SDA072358R1	1SDA072988R1
				E2.2S 1600 Ekip Hi-Touch LSIG	1SDA072359R1	1SDA072989R1
				2000	85	66
	E2.2S 2000 Ekip Dip LSI	1SDA072392R1	1SDA073022R1			
	E2.2S 2000 Ekip Dip LSIG	1SDA072393R1	1SDA073023R1			
	E2.2S 2000 Ekip Touch LI	1SDA072394R1	1SDA073024R1			
	E2.2S 2000 Ekip Touch LSI	1SDA072395R1	1SDA073025R1			
	E2.2S 2000 Ekip Touch LSIG	1SDA072396R1	1SDA073026R1			
	E2.2S 2000 Ekip Hi-Touch LSI	1SDA072398R1	1SDA073028R1			
	E2.2S 2000 Ekip Hi-Touch LSIG	1SDA072399R1	1SDA073029R1			
	2500	85	66			
				E2.2S 2500 Ekip Dip LSI	1SDA072422R1	1SDA073052R1
				E2.2S 2500 Ekip Dip LSIG	1SDA072423R1	1SDA073053R1
				E2.2S 2500 Ekip Touch LI	1SDA072424R1	1SDA073054R1
				E2.2S 2500 Ekip Touch LSI	1SDA072425R1	1SDA073055R1
E2.2S 2500 Ekip Touch LSIG				1SDA072426R1	1SDA073056R1	
E2.2S 2500 Ekip Hi-Touch LSI				1SDA072428R1	1SDA073058R1	
E2.2S 2500 Ekip Hi-Touch LSIG				1SDA072429R1	1SDA073059R1	

Automatic circuit-breakers

Withdrawable version for power distribution



1SDC200023D0203

SACE Emax E2.2H • Mobile part of withdrawable circuit-breaker (MP)

Size	Iu	Icu (440 V)	Icw (1s)	Type	3 Poles		4 Poles	
					Code		Code	
E2.2H	800	100	85	E2.2H 800 Ekip Dip LI	1SDA072261R1		1SDA072891R1	
				E2.2H 800 Ekip Dip LSI	1SDA072262R1		1SDA072892R1	
				E2.2H 800 Ekip Dip LSIG	1SDA072263R1		1SDA072893R1	
				E2.2H 800 Ekip Touch LI	1SDA072264R1		1SDA072894R1	
				E2.2H 800 Ekip Touch LSI	1SDA072265R1		1SDA072895R1	
				E2.2H 800 Ekip Touch LSIG	1SDA072266R1		1SDA072896R1	
				E2.2H 800 Ekip Hi-Touch LSI	1SDA072268R1		1SDA072898R1	
				E2.2H 800 Ekip Hi-Touch LSIG	1SDA072269R1		1SDA072899R1	
	1000	100	85	E2.2H 1000 Ekip Dip LI	1SDA072291R1		1SDA072921R1	
				E2.2H 1000 Ekip Dip LSI	1SDA072292R1		1SDA072922R1	
				E2.2H 1000 Ekip Dip LSIG	1SDA072293R1		1SDA072923R1	
				E2.2H 1000 Ekip Touch LI	1SDA072294R1		1SDA072924R1	
				E2.2H 1000 Ekip Touch LSI	1SDA072295R1		1SDA072925R1	
				E2.2H 1000 Ekip Touch LSIG	1SDA072296R1		1SDA072926R1	
				E2.2H 1000 Ekip Hi-Touch LSI	1SDA072298R1		1SDA072928R1	
				E2.2H 1000 Ekip Hi-Touch LSIG	1SDA072299R1		1SDA072929R1	
	1250	100	85	E2.2H 1250 Ekip Dip LI	1SDA072321R1		1SDA072951R1	
				E2.2H 1250 Ekip Dip LSI	1SDA072322R1		1SDA072952R1	
				E2.2H 1250 Ekip Dip LSIG	1SDA072323R1		1SDA072953R1	
				E2.2H 1250 Ekip Touch LI	1SDA072324R1		1SDA072954R1	
				E2.2H 1250 Ekip Touch LSI	1SDA072325R1		1SDA072955R1	
				E2.2H 1250 Ekip Touch LSIG	1SDA072326R1		1SDA072956R1	
				E2.2H 1250 Ekip Hi-Touch LSI	1SDA072328R1		1SDA072958R1	
				E2.2H 1250 Ekip Hi-Touch LSIG	1SDA072329R1		1SDA072959R1	
	1600	100	85	E2.2H 1600 Ekip Dip LI	1SDA072361R1		1SDA072991R1	
				E2.2H 1600 Ekip Dip LSI	1SDA072362R1		1SDA072992R1	
				E2.2H 1600 Ekip Dip LSIG	1SDA072363R1		1SDA072993R1	
				E2.2H 1600 Ekip Touch LI	1SDA072364R1		1SDA072994R1	
				E2.2H 1600 Ekip Touch LSI	1SDA072365R1		1SDA072995R1	
				E2.2H 1600 Ekip Touch LSIG	1SDA072366R1		1SDA072996R1	
				E2.2H 1600 Ekip Hi-Touch LSI	1SDA072368R1		1SDA072998R1	
				E2.2H 1600 Ekip Hi-Touch LSIG	1SDA072369R1		1SDA072999R1	
	2000	100	85	E2.2H 2000 Ekip Dip LI	1SDA072401R1		1SDA073031R1	
				E2.2H 2000 Ekip Dip LSI	1SDA072402R1		1SDA073032R1	
				E2.2H 2000 Ekip Dip LSIG	1SDA072403R1		1SDA073033R1	
				E2.2H 2000 Ekip Touch LI	1SDA072404R1		1SDA073034R1	
				E2.2H 2000 Ekip Touch LSI	1SDA072405R1		1SDA073035R1	
				E2.2H 2000 Ekip Touch LSIG	1SDA072406R1		1SDA073036R1	
				E2.2H 2000 Ekip Hi-Touch LSI	1SDA072408R1		1SDA073038R1	
				E2.2H 2000 Ekip Hi-Touch LSIG	1SDA072409R1		1SDA073039R1	
	2500	100	85	E2.2H 2500 Ekip Dip LI	1SDA072431R1		1SDA073061R1	
				E2.2H 2500 Ekip Dip LSI	1SDA072432R1		1SDA073062R1	
				E2.2H 2500 Ekip Dip LSIG	1SDA072433R1		1SDA073063R1	
				E2.2H 2500 Ekip Touch LI	1SDA072434R1		1SDA073064R1	
				E2.2H 2500 Ekip Touch LSI	1SDA072435R1		1SDA073065R1	
				E2.2H 2500 Ekip Touch LSIG	1SDA072436R1		1SDA073066R1	
				E2.2H 2500 Ekip Hi-Touch LSI	1SDA072438R1		1SDA073068R1	
				E2.2H 2500 Ekip Hi-Touch LSIG	1SDA072439R1		1SDA073069R1	



1SDC20086/F001

SACE Emax E4.2N-S-H • Mobile part of withdrawable circuit-breaker (MP)

Size	Iu	Icu (440 V)	Icw (1s)	Type	3 Poles		4 Poles	
					Code		Code	
E4.2N	3200	66	66	E4.2N 3200 Ekip Dip LI	1SDA072491R1		1SDA073121R1	
				E4.2N 3200 Ekip Dip LSI	1SDA072492R1		1SDA073122R1	
				E4.2N 3200 Ekip Dip LSIG	1SDA072493R1		1SDA073123R1	
				E4.2N 3200 Ekip Touch LI	1SDA072494R1		1SDA073124R1	
				E4.2N 3200 Ekip Touch LSI	1SDA072495R1		1SDA073125R1	
				E4.2N 3200 Ekip Touch LSIG	1SDA072496R1		1SDA073126R1	
				E4.2N 3200 Ekip Hi-Touch LSI	1SDA072498R1		1SDA073128R1	
				E4.2N 3200 Ekip Hi-Touch LSIG	1SDA072499R1		1SDA073129R1	
	4000	66	66	E4.2N 4000 Ekip Dip LI	1SDA072541R1		1SDA073171R1	
				E4.2N 4000 Ekip Dip LSI	1SDA072542R1		1SDA073172R1	
				E4.2N 4000 Ekip Dip LSIG	1SDA072543R1		1SDA073173R1	
				E4.2N 4000 Ekip Touch LI	1SDA072544R1		1SDA073174R1	
				E4.2N 4000 Ekip Touch LSI	1SDA072545R1		1SDA073175R1	
				E4.2N 4000 Ekip Touch LSIG	1SDA072546R1		1SDA073176R1	
				E4.2N 4000 Ekip Hi-Touch LSI	1SDA072548R1		1SDA073178R1	
				E4.2N 4000 Ekip Hi-Touch LSIG	1SDA072549R1		1SDA073179R1	
E4.2S	3200	85	66	E4.2S 3200 Ekip Dip LI	1SDA072501R1		1SDA073131R1	
				E4.2S 3200 Ekip Dip LSI	1SDA072502R1		1SDA073132R1	
				E4.2S 3200 Ekip Dip LSIG	1SDA072503R1		1SDA073133R1	
				E4.2S 3200 Ekip Touch LI	1SDA072504R1		1SDA073134R1	
				E4.2S 3200 Ekip Touch LSI	1SDA072505R1		1SDA073135R1	
				E4.2S 3200 Ekip Touch LSIG	1SDA072506R1		1SDA073136R1	
				E4.2S 3200 Ekip Hi-Touch LSI	1SDA072508R1		1SDA073138R1	
				E4.2S 3200 Ekip Hi-Touch LSIG	1SDA072509R1		1SDA073139R1	
	4000	85	66	E4.2S 4000 Ekip Dip LI	1SDA072551R1		1SDA073181R1	
				E4.2S 4000 Ekip Dip LSI	1SDA072552R1		1SDA073182R1	
				E4.2S 4000 Ekip Dip LSIG	1SDA072553R1		1SDA073183R1	
				E4.2S 4000 Ekip Touch LI	1SDA072554R1		1SDA073184R1	
				E4.2S 4000 Ekip Touch LSI	1SDA072555R1		1SDA073185R1	
				E4.2S 4000 Ekip Touch LSIG	1SDA072556R1		1SDA073186R1	
				E4.2S 4000 Ekip Hi-Touch LSI	1SDA072558R1		1SDA073188R1	
				E4.2S 4000 Ekip Hi-Touch LSIG	1SDA072559R1		1SDA073189R1	
E4.2H	3200	100	85	E4.2H 3200 Ekip Dip LI	1SDA072511R1		1SDA073141R1	
				E4.2H 3200 Ekip Dip LSI	1SDA072512R1		1SDA073142R1	
				E4.2H 3200 Ekip Dip LSIG	1SDA072513R1		1SDA073143R1	
				E4.2H 3200 Ekip Touch LI	1SDA072514R1		1SDA073144R1	
				E4.2H 3200 Ekip Touch LSI	1SDA072515R1		1SDA073145R1	
				E4.2H 3200 Ekip Touch LSIG	1SDA072516R1		1SDA073146R1	
				E4.2H 3200 Ekip Hi-Touch LSI	1SDA072518R1		1SDA073148R1	
				E4.2H 3200 Ekip Hi-Touch LSIG	1SDA072519R1		1SDA073149R1	
	4000	100	85	E4.2H 4000 Ekip Dip LI	1SDA072561R1		1SDA073191R1	
				E4.2H 4000 Ekip Dip LSI	1SDA072562R1		1SDA073192R1	
				E4.2H 4000 Ekip Dip LSIG	1SDA072563R1		1SDA073193R1	
				E4.2H 4000 Ekip Touch LI	1SDA072564R1		1SDA073194R1	
				E4.2H 4000 Ekip Touch LSI	1SDA072565R1		1SDA073195R1	
				E4.2H 4000 Ekip Touch LSIG	1SDA072566R1		1SDA073196R1	
				E4.2H 4000 Ekip Hi-Touch LSI	1SDA072568R1		1SDA073198R1	
				E4.2H 4000 Ekip Hi-Touch LSIG	1SDA072569R1		1SDA073199R1	

Automatic circuit-breakers

Withdrawable version for power distribution



SACE Emax E4.2V • Mobile part of withdrawable circuit-breaker (MP)

Size	Iu	Icu (440 V)	Icw (1s)	Type	3 Poles		4 Poles	
					Code		Code	
E4.2V	2000	150	100	E4.2V 2000 Ekip Dip LI	1SDA072451R1		1SDA073081R1	
				E4.2V 2000 Ekip Dip LSI	1SDA072452R1		1SDA073082R1	
				E4.2V 2000 Ekip Dip LSIG	1SDA072453R1		1SDA073083R1	
				E4.2V 2000 Ekip Touch LI	1SDA072454R1		1SDA073084R1	
				E4.2V 2000 Ekip Touch LSI	1SDA072455R1		1SDA073085R1	
				E4.2V 2000 Ekip Touch LSIG	1SDA072456R1		1SDA073086R1	
				E4.2V 2000 Ekip Hi-Touch LSI	1SDA072458R1		1SDA073088R1	
				E4.2V 2000 Ekip Hi-Touch LSIG	1SDA072459R1		1SDA073089R1	
	2500	150	100	E4.2V 2500 Ekip Dip LI	1SDA072471R1		1SDA073101R1	
				E4.2V 2500 Ekip Dip LSI	1SDA072472R1		1SDA073102R1	
				E4.2V 2500 Ekip Dip LSIG	1SDA072473R1		1SDA073103R1	
				E4.2V 2500 Ekip Touch LI	1SDA072474R1		1SDA073104R1	
				E4.2V 2500 Ekip Touch LSI	1SDA072475R1		1SDA073105R1	
				E4.2V 2500 Ekip Touch LSIG	1SDA072476R1		1SDA073106R1	
				E4.2V 2500 Ekip Hi-Touch LSI	1SDA072478R1		1SDA073108R1	
				E4.2V 2500 Ekip Hi-Touch LSIG	1SDA072479R1		1SDA073109R1	
	3200	150	100	E4.2V 3200 Ekip Dip LI	1SDA072521R1		1SDA073151R1	
				E4.2V 3200 Ekip Dip LSI	1SDA072522R1		1SDA073152R1	
				E4.2V 3200 Ekip Dip LSIG	1SDA072523R1		1SDA073153R1	
				E4.2V 3200 Ekip Touch LI	1SDA072524R1		1SDA073154R1	
				E4.2V 3200 Ekip Touch LSI	1SDA072525R1		1SDA073155R1	
				E4.2V 3200 Ekip Touch LSIG	1SDA072526R1		1SDA073156R1	
				E4.2V 3200 Ekip Hi-Touch LSI	1SDA072528R1		1SDA073158R1	
				E4.2V 3200 Ekip Hi-Touch LSIG	1SDA072529R1		1SDA073159R1	
	4000	150	100	E4.2V 4000 Ekip Dip LI	1SDA072571R1		1SDA073201R1	
				E4.2V 4000 Ekip Dip LSI	1SDA072572R1		1SDA073202R1	
				E4.2V 4000 Ekip Dip LSIG	1SDA072573R1		1SDA073203R1	
				E4.2V 4000 Ekip Touch LI	1SDA072574R1		1SDA073204R1	
E4.2V 4000 Ekip Touch LSI				1SDA072575R1		1SDA073205R1		
E4.2V 4000 Ekip Touch LSIG				1SDA072576R1		1SDA073206R1		
E4.2V 4000 Ekip Hi-Touch LSI				1SDA072578R1		1SDA073208R1		
E4.2V 4000 Ekip Hi-Touch LSIG				1SDA072579R1		1SDA073209R1		



1SDC20023D0203

SACE Emax E6.2H-V • Mobile part of withdrawable circuit-breaker (MP)

Size	Iu	Icu (440 V)	Icw (1s)	Type	3 Poles		4 Poles	
					Code		Code	
E6.2H	4000	100	100	E6.2H 4000 Ekip Dip LI	1SDA072581R1		1SDA073211R1	
				E6.2H 4000 Ekip Dip LSI	1SDA072582R1		1SDA073212R1	
				E6.2H 4000 Ekip Dip LSIG	1SDA072583R1		1SDA073213R1	
				E6.2H 4000 Ekip Touch LI	1SDA072584R1		1SDA073214R1	
				E6.2H 4000 Ekip Touch LSI	1SDA072585R1		1SDA073215R1	
				E6.2H 4000 Ekip Touch LSIG	1SDA072586R1		1SDA073216R1	
				E6.2H 4000 Ekip Hi-Touch LSI	1SDA072588R1		1SDA073218R1	
				E6.2H 4000 Ekip Hi-Touch LSIG	1SDA072589R1		1SDA073219R1	
	5000	100	100	E6.2H 5000 Ekip Dip LI	1SDA072611R1		1SDA073241R1	
				E6.2H 5000 Ekip Dip LSI	1SDA072612R1		1SDA073242R1	
				E6.2H 5000 Ekip Dip LSIG	1SDA072613R1		1SDA073243R1	
				E6.2H 5000 Ekip Touch LI	1SDA072614R1		1SDA073244R1	
				E6.2H 5000 Ekip Touch LSI	1SDA072615R1		1SDA073245R1	
				E6.2H 5000 Ekip Touch LSIG	1SDA072616R1		1SDA073246R1	
				E6.2H 5000 Ekip Hi-Touch LSI	1SDA072618R1		1SDA073248R1	
				E6.2H 5000 Ekip Hi-Touch LSIG	1SDA072619R1		1SDA073249R1	
	6300	100	100	E6.2H 6300 Ekip Dip LI	1SDA072641R1		1SDA073271R1	
				E6.2H 6300 Ekip Dip LSI	1SDA072642R1		1SDA073272R1	
				E6.2H 6300 Ekip Dip LSIG	1SDA072643R1		1SDA073273R1	
				E6.2H 6300 Ekip Touch LI	1SDA072644R1		1SDA073274R1	
				E6.2H 6300 Ekip Touch LSI	1SDA072645R1		1SDA073275R1	
				E6.2H 6300 Ekip Touch LSIG	1SDA072646R1		1SDA073276R1	
				E6.2H 6300 Ekip Hi-Touch LSI	1SDA072648R1		1SDA073278R1	
				E6.2H 6300 Ekip Hi-Touch LSIG	1SDA072649R1		1SDA073279R1	
E6.2V	4000	150	100	E6.2V 4000 Ekip Dip LI	1SDA072591R1		1SDA073221R1	
				E6.2V 4000 Ekip Dip LSI	1SDA072592R1		1SDA073222R1	
				E6.2V 4000 Ekip Dip LSIG	1SDA072593R1		1SDA073223R1	
				E6.2V 4000 Ekip Touch LI	1SDA072594R1		1SDA073224R1	
				E6.2V 4000 Ekip Touch LSI	1SDA072595R1		1SDA073225R1	
				E6.2V 4000 Ekip Touch LSIG	1SDA072596R1		1SDA073226R1	
				E6.2V 4000 Ekip Hi-Touch LSI	1SDA072598R1		1SDA073228R1	
				E6.2V 4000 Ekip Hi-Touch LSIG	1SDA072599R1		1SDA073229R1	
	5000	150	100	E6.2V 5000 Ekip Dip LI	1SDA072621R1		1SDA073251R1	
				E6.2V 5000 Ekip Dip LSI	1SDA072622R1		1SDA073252R1	
				E6.2V 5000 Ekip Dip LSIG	1SDA072623R1		1SDA073253R1	
				E6.2V 5000 Ekip Touch LI	1SDA072624R1		1SDA073254R1	
				E6.2V 5000 Ekip Touch LSI	1SDA072625R1		1SDA073255R1	
				E6.2V 5000 Ekip Touch LSIG	1SDA072626R1		1SDA073256R1	
				E6.2V 5000 Ekip Hi-Touch LSI	1SDA072628R1		1SDA073258R1	
				E6.2V 5000 Ekip Hi-Touch LSIG	1SDA072629R1		1SDA073259R1	
	6300	150	100	E6.2V 6300 Ekip Dip LI	1SDA072651R1		1SDA073281R1	
				E6.2V 6300 Ekip Dip LSI	1SDA072652R1		1SDA073282R1	
				E6.2V 6300 Ekip Dip LSIG	1SDA072653R1		1SDA073283R1	
				E6.2V 6300 Ekip Touch LI	1SDA072654R1		1SDA073284R1	
				E6.2V 6300 Ekip Touch LSI	1SDA072655R1		1SDA073285R1	
				E6.2V 6300 Ekip Touch LSIG	1SDA072656R1		1SDA073286R1	
				E6.2V 6300 Ekip Hi-Touch LSI	1SDA072658R1		1SDA073288R1	
				E6.2V 6300 Ekip Hi-Touch LSIG	1SDA072659R1		1SDA073289R1	

Automatic circuit-breakers

Withdrawable version for power distribution



SACE Emax E6.2X • Mobile part of withdrawable circuit-breaker (MP)

Size	Iu	Icu (440 V)	Icw (1s)	Type	3 Poles		4 Poles	
					Code		Code	
E6.2X	4000	200	120	E6.2X 4000 Ekip Dip LI	1SDA072601R1		1SDA073231R1	
				E6.2X 4000 Ekip Dip LSI	1SDA072602R1		1SDA073232R1	
				E6.2X 4000 Ekip Dip LSIG	1SDA072603R1		1SDA073233R1	
				E6.2X 4000 Ekip Touch LI	1SDA072604R1		1SDA073234R1	
				E6.2X 4000 Ekip Touch LSI	1SDA072605R1		1SDA073235R1	
				E6.2X 4000 Ekip Touch LSIG	1SDA072606R1		1SDA073236R1	
				E6.2X 4000 Ekip Hi-Touch LSI	1SDA072608R1		1SDA073238R1	
				E6.2X 4000 Ekip Hi-Touch LSIG	1SDA072609R1		1SDA073239R1	
	5000	200	120	E6.2X 5000 Ekip Dip LI	1SDA072631R1		1SDA073261R1	
				E6.2X 5000 Ekip Dip LSI	1SDA072632R1		1SDA073262R1	
				E6.2X 5000 Ekip Dip LSIG	1SDA072633R1		1SDA073263R1	
				E6.2X 5000 Ekip Touch LI	1SDA072634R1		1SDA073264R1	
				E6.2X 5000 Ekip Touch LSI	1SDA072635R1		1SDA073265R1	
				E6.2X 5000 Ekip Touch LSIG	1SDA072636R1		1SDA073266R1	
				E6.2X 5000 Ekip Hi-Touch LSI	1SDA072638R1		1SDA073268R1	
				E6.2X 5000 Ekip Hi-Touch LSIG	1SDA072639R1		1SDA073269R1	
	6300	200	120	E6.2X 6300 Ekip Dip LI	1SDA072661R1		1SDA073291R1	
				E6.2X 6300 Ekip Dip LSI	1SDA072662R1		1SDA073292R1	
				E6.2X 6300 Ekip Dip LSIG	1SDA072663R1		1SDA073293R1	
				E6.2X 6300 Ekip Touch LI	1SDA072664R1		1SDA073294R1	
				E6.2X 6300 Ekip Touch LSI	1SDA072665R1		1SDA073295R1	
				E6.2X 6300 Ekip Touch LSIG	1SDA072666R1		1SDA073296R1	
				E6.2X 6300 Ekip Hi-Touch LSI	1SDA072668R1		1SDA073298R1	
				E6.2X 6300 Ekip Hi-Touch LSIG	1SDA072669R1		1SDA073299R1	



1SDC200669F001

SACE Emax E6.2H-V/f Full size • Mobile part of withdrawable circuit-breaker (MP)

Size	Iu	Icu (440 V)	Icw (1s)	Type	4 Poles	
					Code	
E6.2H/f	4000	100	100	E6.2H/f 4000 Ekip Dip LI	1SDA073301R1	
				E6.2H/f 4000 Ekip Dip LSI	1SDA073302R1	
				E6.2H/f 4000 Ekip Dip LSIG	1SDA073303R1	
				E6.2H/f 4000 Ekip Touch LI	1SDA073304R1	
				E6.2H/f 4000 Ekip Touch LSI	1SDA073305R1	
				E6.2H/f 4000 Ekip Touch LSIG	1SDA073306R1	
				E6.2H/f 4000 Ekip Hi-Touch LSI	1SDA073308R1	
				E6.2H/f 4000 Ekip Hi-Touch LSIG	1SDA073309R1	
	5000	100	100	E6.2H/f 5000 Ekip Dip LI	1SDA073331R1	
				E6.2H/f 5000 Ekip Dip LSI	1SDA073332R1	
				E6.2H/f 5000 Ekip Dip LSIG	1SDA073333R1	
				E6.2H/f 5000 Ekip Touch LI	1SDA073334R1	
				E6.2H/f 5000 Ekip Touch LSI	1SDA073335R1	
				E6.2H/f 5000 Ekip Touch LSIG	1SDA073336R1	
				E6.2H/f 5000 Ekip Hi-Touch LSI	1SDA073338R1	
				E6.2H/f 5000 Ekip Hi-Touch LSIG	1SDA073339R1	
	6300	100	100	E6.2H/f 6300 Ekip Dip LI	1SDA073361R1	
				E6.2H/f 6300 Ekip Dip LSI	1SDA073362R1	
				E6.2H/f 6300 Ekip Dip LSIG	1SDA073363R1	
				E6.2H/f 6300 Ekip Touch LI	1SDA073364R1	
				E6.2H/f 6300 Ekip Touch LSI	1SDA073365R1	
				E6.2H/f 6300 Ekip Touch LSIG	1SDA073366R1	
				E6.2H/f 6300 Ekip Hi-Touch LSI	1SDA073368R1	
				E6.2H/f 6300 Ekip Hi-Touch LSIG	1SDA073369R1	
E6.2V/f	4000	150	100	E6.2V/f 4000 Ekip Dip LI	1SDA073311R1	
				E6.2V/f 4000 Ekip Dip LSI	1SDA073312R1	
				E6.2V/f 4000 Ekip Dip LSIG	1SDA073313R1	
				E6.2V/f 4000 Ekip Touch LI	1SDA073314R1	
				E6.2V/f 4000 Ekip Touch LSI	1SDA073315R1	
				E6.2V/f 4000 Ekip Touch LSIG	1SDA073316R1	
				E6.2V/f 4000 Ekip Hi-Touch LSI	1SDA073318R1	
				E6.2V/f 4000 Ekip Hi-Touch LSIG	1SDA073319R1	
	5000	150	100	E6.2V/f 5000 Ekip Dip LI	1SDA073341R1	
				E6.2V/f 5000 Ekip Dip LSI	1SDA073342R1	
				E6.2V/f 5000 Ekip Dip LSIG	1SDA073343R1	
				E6.2V/f 5000 Ekip Touch LI	1SDA073344R1	
				E6.2V/f 5000 Ekip Touch LSI	1SDA073345R1	
				E6.2V/f 5000 Ekip Touch LSIG	1SDA073346R1	
				E6.2V/f 5000 Ekip Hi-Touch LSI	1SDA073348R1	
				E6.2V/f 5000 Ekip Hi-Touch LSIG	1SDA073349R1	
	6300	150	100	E6.2V/f 6300 Ekip Dip LI	1SDA073371R1	
				E6.2V/f 6300 Ekip Dip LSI	1SDA073372R1	
				E6.2V/f 6300 Ekip Dip LSIG	1SDA073373R1	
				E6.2V/f 6300 Ekip Touch LI	1SDA073374R1	
				E6.2V/f 6300 Ekip Touch LSI	1SDA073375R1	
				E6.2V/f 6300 Ekip Touch LSIG	1SDA073376R1	
				E6.2V/f 6300 Ekip Hi-Touch LSI	1SDA073378R1	
				E6.2V/f 6300 Ekip Hi-Touch LSIG	1SDA073379R1	

Automatic circuit-breakers

Withdrawable version for power distribution



SACE Emax E6.2X/f Full size • Mobile part of withdrawable circuit-breaker (MP)

Size	Iu	Icu (440 V)	Icw (1s)	Type	4 Poles	
					Code	
E6.2X/f	4000	200	120	E6.2X/f 4000 Ekip Dip LI	1SDA073321R1	
				E6.2X/f 4000 Ekip Dip LSI	1SDA073322R1	
				E6.2X/f 4000 Ekip Dip LSIG	1SDA073323R1	
				E6.2X/f 4000 Ekip Touch LI	1SDA073324R1	
				E6.2X/f 4000 Ekip Touch LSI	1SDA073325R1	
				E6.2X/f 4000 Ekip Touch LSIG	1SDA073326R1	
				E6.2X/f 4000 Ekip Hi-Touch LSI	1SDA073328R1	
				E6.2X/f 4000 Ekip Hi-Touch LSIG	1SDA073329R1	
				5000	200	120
	E6.2X/f 5000 Ekip Dip LSI	1SDA073352R1				
	E6.2X/f 5000 Ekip Dip LSIG	1SDA073353R1				
	E6.2X/f 5000 Ekip Touch LI	1SDA073354R1				
	E6.2X/f 5000 Ekip Touch LSI	1SDA073355R1				
	E6.2X/f 5000 Ekip Touch LSIG	1SDA073356R1				
	6300	200	120	E6.2X/f 6300 Ekip Dip LI	1SDA073381R1	
E6.2X/f 6300 Ekip Dip LSI				1SDA073382R1		
E6.2X/f 6300 Ekip Dip LSIG				1SDA073383R1		
E6.2X/f 6300 Ekip Touch LI				1SDA073384R1		
E6.2X/f 6300 Ekip Touch LSI				1SDA073385R1		
E6.2X/f 6300 Ekip Touch LSIG				1SDA073386R1		
E6.2X/f 6300 Ekip Hi-Touch LSI				1SDA073388R1		
E6.2X/f 6300 Ekip Hi-Touch LSIG				1SDA073389R1		

Automatic circuit-breakers

Fixed version for generators



SACE Emax E1.2B-C-N-L • Front terminals (F)

Size	Iu	Icu (440 V)	Icw (1s)	Type	3 Poles		4 Poles		
					Code		Code		
E1.2B	630	42	42	E1.2B 630 Ekip G Touch LSIG	1SDA070707R1		1SDA071337R1		
				E1.2B 630 Ekip G Hi-Touch LSIG	1SDA070710R1		1SDA071340R1		
	800	42	42	E1.2B 800 Ekip G Touch LSIG	1SDA070747R1		1SDA071377R1		
				E1.2B 800 Ekip G Hi-Touch LSIG	1SDA070750R1		1SDA071380R1		
	1000	42	42	E1.2B 1000 Ekip G Touch LSIG	1SDA070787R1		1SDA071417R1		
				E1.2B 1000 Ekip G Hi-Touch LSIG	1SDA070790R1		1SDA071420R1		
	1250	42	42	E1.2B 1250 Ekip G Touch LSIG	1SDA070827R1		1SDA071457R1		
				E1.2B 1250 Ekip G Hi-Touch LSIG	1SDA070830R1		1SDA071460R1		
	1600	42	42	E1.2B 1600 Ekip G Touch LSIG	1SDA070867R1		1SDA071497R1		
				E1.2B 1600 Ekip G Hi-Touch LSIG	1SDA070870R1		1SDA071500R1		
	E1.2C	630	50	42	E1.2C 630 Ekip G Touch LSIG	1SDA070717R1		1SDA071347R1	
					E1.2C 630 Ekip G Hi-Touch LSIG	1SDA070720R1		1SDA071350R1	
800		50	42	E1.2C 800 Ekip G Touch LSIG	1SDA070757R1		1SDA071387R1		
				E1.2C 800 Ekip G Hi-Touch LSIG	1SDA070760R1		1SDA071390R1		
1000		50	42	E1.2C 1000 Ekip G Touch LSIG	1SDA070797R1		1SDA071427R1		
				E1.2C 1000 Ekip G Hi-Touch LSIG	1SDA070800R1		1SDA071430R1		
1250		50	42	E1.2C 1250 Ekip G Touch LSIG	1SDA070837R1		1SDA071467R1		
				E1.2C 1250 Ekip G Hi-Touch LSIG	1SDA070840R1		1SDA071470R1		
1600		50	42	E1.2C 1600 Ekip G Touch LSIG	1SDA070877R1		1SDA071507R1		
				E1.2C 1600 Ekip G Hi-Touch LSIG	1SDA070880R1		1SDA071510R1		
E1.2N		250	66	50	E1.2N 250 Ekip G Touch LSIG	1SDA070697R1		1SDA071327R1	
					E1.2N 250 Ekip G Hi-Touch LSIG	1SDA070700R1		1SDA071330R1	
	630	66	50	E1.2N 630 Ekip G Touch LSIG	1SDA070727R1		1SDA071357R1		
				E1.2N 630 Ekip G Hi-Touch LSIG	1SDA070730R1		1SDA071360R1		
	800	66	50	E1.2N 800 Ekip G Touch LSIG	1SDA070767R1		1SDA071397R1		
				E1.2N 800 Ekip G Hi-Touch LSIG	1SDA070770R1		1SDA071400R1		
	1000	66	50	E1.2N 1000 Ekip G Touch LSIG	1SDA070807R1		1SDA071437R1		
				E1.2N 1000 Ekip G Hi-Touch LSIG	1SDA070810R1		1SDA071440R1		
	1250	66	50	E1.2N 1250 Ekip G Touch LSIG	1SDA070847R1		1SDA071477R1		
				E1.2N 1250 Ekip G Hi-Touch LSIG	1SDA070850R1		1SDA071480R1		
	1600	66	50	E1.2N 1600 Ekip G Touch LSIG	1SDA070887R1		1SDA071517R1		
				E1.2N 1600 Ekip G Hi-Touch LSIG	1SDA070890R1		1SDA071520R1		
E1.2L	630	130	15	E1.2L 630 Ekip G Touch LSIG	1SDA070737R1		1SDA071367R1		
				E1.2L 630 Ekip G Hi-Touch LSIG	1SDA070740R1		1SDA071370R1		
	800	130	15	E1.2L 800 Ekip G Touch LSIG	1SDA070777R1		1SDA071407R1		
				E1.2L 800 Ekip G Hi-Touch LSIG	1SDA070780R1		1SDA071410R1		
	1000	130	15	E1.2L 1000 Ekip G Touch LSIG	1SDA070817R1		1SDA071447R1		
				E1.2L 1000 Ekip G Hi-Touch LSIG	1SDA070820R1		1SDA071450R1		
	1250	130	15	E1.2L 1250 Ekip G Touch LSIG	1SDA070857R1		1SDA071487R1		
				E1.2L 1250 Ekip G Hi-Touch LSIG	1SDA070860R1		1SDA071490R1		

Automatic circuit-breakers

Fixed version for generators



SACE Emax E2.2B-N-S-H • Orientable rear terminals (HR)

Size	I _u	I _{cu} (440 V)	I _{cw} (1s)	Type	3 Poles		4 Poles		
					Code		Code		
E2.2B	1600	42	42	E2.2B 1600 Ekip G Touch LSIG	1SDA070987R1		1SDA071617R1		
				E2.2B 1600 Ekip G Hi-Touch LSIG	1SDA070990R1		1SDA071620R1		
	2000	42	42	E2.2B 2000 Ekip G Touch LSIG	1SDA071027R1		1SDA071657R1		
				E2.2B 2000 Ekip G Hi-Touch LSIG	1SDA071030R1		1SDA071660R1		
E2.2N	800	66	66	E2.2N 800 Ekip G Touch LSIG	1SDA070897R1		1SDA071527R1		
				E2.2N 800 Ekip G Hi-Touch LSIG	1SDA070900R1		1SDA071530R1		
	1000	66	66	E2.2N 1000 Ekip G Touch LSIG	1SDA070927R1		1SDA071557R1		
				E2.2N 1000 Ekip G Hi-Touch LSIG	1SDA070930R1		1SDA071560R1		
	1250	66	66	E2.2N 1250 Ekip G Touch LSIG	1SDA070957R1		1SDA071587R1		
				E2.2N 1250 Ekip G Hi-Touch LSIG	1SDA070960R1		1SDA071590R1		
	1600	66	66	E2.2N 1600 Ekip G Touch LSIG	1SDA070997R1		1SDA071627R1		
				E2.2N 1600 Ekip G Hi-Touch LSIG	1SDA071000R1		1SDA071630R1		
	2000	66	66	E2.2N 2000 Ekip G Touch LSIG	1SDA071037R1		1SDA071667R1		
				E2.2N 2000 Ekip G Hi-Touch LSIG	1SDA071040R1		1SDA071670R1		
	2500	66	66	E2.2N 2500 Ekip G Touch LSIG	1SDA071067R1		1SDA071697R1		
				E2.2N 2500 Ekip G Hi-Touch LSIG	1SDA071070R1		1SDA071700R1		
	E2.2S	250	85	66	E2.2S 250 Ekip G Touch LSIG	1SDA073634R1		1SDA073644R1	
					E2.2S 250 Ekip G Hi-Touch LSIG	1SDA073637R1		1SDA073647R1	
800		85	66	E2.2S 800 Ekip G Touch LSIG	1SDA070907R1		1SDA071537R1		
				E2.2S 800 Ekip G Hi-Touch LSIG	1SDA070910R1		1SDA071540R1		
1000		85	66	E2.2S 1000 Ekip G Touch LSIG	1SDA070937R1		1SDA071567R1		
				E2.2S 1000 Ekip G Hi-Touch LSIG	1SDA070940R1		1SDA071570R1		
1250		85	66	E2.2S 1250 Ekip G Touch LSIG	1SDA070967R1		1SDA071597R1		
				E2.2S 1250 Ekip G Hi-Touch LSIG	1SDA070970R1		1SDA071600R1		
1600		85	66	E2.2S 1600 Ekip G Touch LSIG	1SDA071007R1		1SDA071637R1		
				E2.2S 1600 Ekip G Hi-Touch LSIG	1SDA071010R1		1SDA071640R1		
2000		85	66	E2.2S 2000 Ekip G Touch LSIG	1SDA071047R1		1SDA071677R1		
				E2.2S 2000 Ekip G Hi-Touch LSIG	1SDA071050R1		1SDA071680R1		
2500		85	66	E2.2S 2500 Ekip G Touch LSIG	1SDA071077R1		1SDA071707R1		
				E2.2S 2500 Ekip G Hi-Touch LSIG	1SDA071080R1		1SDA071710R1		
E2.2H	800	100	85	E2.2H 800 Ekip G Touch LSIG	1SDA070917R1		1SDA071547R1		
				E2.2H 800 Ekip G Hi-Touch LSIG	1SDA070920R1		1SDA071550R1		
	1000	100	85	E2.2H 1000 Ekip G Touch LSIG	1SDA070947R1		1SDA071577R1		
				E2.2H 1000 Ekip G Hi-Touch LSIG	1SDA070950R1		1SDA071580R1		
	1250	100	85	E2.2H 1250 Ekip G Touch LSIG	1SDA070977R1		1SDA071607R1		
				E2.2H 1250 Ekip G Hi-Touch LSIG	1SDA070980R1		1SDA071610R1		
	1600	100	85	E2.2H 1600 Ekip G Touch LSIG	1SDA071017R1		1SDA071647R1		
				E2.2H 1600 Ekip G Hi-Touch LSIG	1SDA071020R1		1SDA071650R1		
	2000	100	85	E2.2H 2000 Ekip G Touch LSIG	1SDA071057R1		1SDA071687R1		
				E2.2H 2000 Ekip G Hi-Touch LSIG	1SDA071060R1		1SDA071690R1		
	2500	100	85	E2.2H 2500 Ekip G Touch LSIG	1SDA071087R1		1SDA071717R1		
				E2.2H 2500 Ekip G Hi-Touch LSIG	1SDA071090R1		1SDA071720R1		



1SDC200023D0203

SACE Emax E4.2N-S-H-V • Orientable rear terminals (HR)

Size	Iu	Icu (440 V)	Icw (1s)	Type	3 Poles		4 Poles	
					Code		Code	
E4.2N	3200	66	66	E4.2N 3200 Ekip G Touch LSIG	1SDA071147R1		1SDA071777R1	
				E4.2N 3200 Ekip G Hi-Touch LSIG	1SDA071150R1		1SDA071780R1	
	4000	66	66	E4.2N 4000 Ekip G Touch LSIG	1SDA071197R1		1SDA071827R1	
				E4.2N 4000 Ekip G Hi-Touch LSIG	1SDA071200R1		1SDA071830R1	
E4.2S	3200	85	66	E4.2S 3200 Ekip G Touch LSIG	1SDA071157R1		1SDA071787R1	
				E4.2S 3200 Ekip G Hi-Touch LSIG	1SDA071160R1		1SDA071790R1	
	4000	85	66	E4.2S 4000 Ekip G Touch LSIG	1SDA071207R1		1SDA071837R1	
				E4.2S 4000 Ekip G Hi-Touch LSIG	1SDA071210R1		1SDA071840R1	
E4.2H	3200	100	85	E4.2H 3200 Ekip G Touch LSIG	1SDA071167R1		1SDA071797R1	
				E4.2H 3200 Ekip G Hi-Touch LSIG	1SDA071170R1		1SDA071800R1	
	4000	100	85	E4.2H 4000 Ekip G Touch LSIG	1SDA071217R1		1SDA071847R1	
				E4.2H 4000 Ekip G Hi-Touch LSIG	1SDA071220R1		1SDA071850R1	
E4.2V	2000	150	100	E4.2V 2000 Ekip G Touch LSIG	1SDA071107R1		1SDA071737R1	
				E4.2V 2000 Ekip G Hi-Touch LSIG	1SDA071110R1		1SDA071740R1	
	2500	150	100	E4.2V 2500 Ekip G Touch LSIG	1SDA071127R1		1SDA071757R1	
				E4.2V 2500 Ekip G Hi-Touch LSIG	1SDA071130R1		1SDA071760R1	
	3200	150	100	E4.2V 3200 Ekip G Touch LSIG	1SDA071177R1		1SDA071807R1	
				E4.2V 3200 Ekip G Hi-Touch LSIG	1SDA071180R1		1SDA071810R1	
	4000	150	100	E4.2V 4000 Ekip G Touch LSIG	1SDA071227R1		1SDA071857R1	
				E4.2V 4000 Ekip G Hi-Touch LSIG	1SDA071230R1		1SDA071860R1	

Automatic circuit-breakers

Fixed version for generators



1SDC200023D0203

SACE Emax E6.2H-V-X • Orientable rear terminals (HR)

Size	Iu	Icu (440 V)	Icw (1s)	Type	3 Poles		4 Poles	
					Code		Code	
E6.2H	4000	100	100	E6.2H 4000 Ekip G Touch LSIg	1SDA071237R1		1SDA071867R1	
				E6.2H 4000 Ekip G Hi-Touch LSIg	1SDA071240R1		1SDA071870R1	
	5000	100	100	E6.2H 5000 Ekip G Touch LSIg	1SDA071267R1		1SDA071897R1	
				E6.2H 5000 Ekip G Hi-Touch LSIg	1SDA071270R1		1SDA071900R1	
	6300	100	100	E6.2H 6300 Ekip G Touch LSIg	1SDA071297R1		1SDA071927R1	
				E6.2H 6300 Ekip G Hi-Touch LSIg	1SDA071300R1		1SDA071930R1	
E6.2V	4000	150	100	E6.2V 4000 Ekip G Touch LSIg	1SDA071247R1		1SDA071877R1	
				E6.2V 4000 Ekip G Hi-Touch LSIg	1SDA071250R1		1SDA071880R1	
	5000	150	100	E6.2V 5000 Ekip G Touch LSIg	1SDA071277R1		1SDA071907R1	
				E6.2V 5000 Ekip G Hi-Touch LSIg	1SDA071280R1		1SDA071910R1	
	6300	150	100	E6.2V 6300 Ekip G Touch LSIg	1SDA071307R1		1SDA071937R1	
				E6.2V 6300 Ekip G Hi-Touch LSIg	1SDA071310R1		1SDA071940R1	
E6.2X	4000	200	120	E6.2X 4000 Ekip G Touch LSIg	1SDA071257R1		1SDA071887R1	
				E6.2X 4000 Ekip G Hi-Touch LSIg	1SDA071260R1		1SDA071890R1	
	5000	200	120	E6.2X 5000 Ekip G Touch LSIg	1SDA071287R1		1SDA071917R1	
				E6.2X 5000 Ekip G Hi-Touch LSIg	1SDA071290R1		1SDA071920R1	
	6300	200	120	E6.2X 6300 Ekip G Touch LSIg	1SDA071317R1		1SDA071947R1	
				E6.2X 6300 Ekip G Hi-Touch LSIg	1SDA071320R1		1SDA071950R1	



SACE Emax E6.2H-V-X/f Full size • Orientable rear terminals (HR)

Size	Iu	Icu (440 V)	Icw (1s)	Type	4 Poles	
					Code	
E6.2H/f	4000	100	100	E6.2H/f 4000 Ekip G Touch LSIG	1SDA071957R1	
				E6.2H/f 4000 Ekip G Hi-Touch LSIG	1SDA071960R1	
	5000	100	100	E6.2H/f 5000 Ekip G Touch LSIG	1SDA071987R1	
				E6.2H/f 5000 Ekip G Hi-Touch LSIG	1SDA071990R1	
	6300	100	100	E6.2H/f 6300 Ekip G Touch LSIG	1SDA072017R1	
				E6.2H/f 6300 Ekip G Hi-Touch LSIG	1SDA072020R1	
E6.2V/f	4000	150	100	E6.2V/f 4000 Ekip G Touch LSIG	1SDA071967R1	
				E6.2V/f 4000 Ekip G Hi-Touch LSIG	1SDA071970R1	
	5000	150	100	E6.2V/f 5000 Ekip G Touch LSIG	1SDA071997R1	
				E6.2V/f 5000 Ekip G Hi-Touch LSIG	1SDA072000R1	
	6300	150	100	E6.2V/f 6300 Ekip G Touch LSIG	1SDA072027R1	
				E6.2V/f 6300 Ekip G Hi-Touch LSIG	1SDA072030R1	
E6.2X/f	4000	200	120	E6.2X/f 4000 Ekip G Touch LSIG	1SDA071977R1	
				E6.2X/f 4000 Ekip G Hi-Touch LSIG	1SDA071980R1	
	5000	200	120	E6.2X/f 5000 Ekip G Touch LSIG	1SDA072007R1	
				E6.2X/f 5000 Ekip G Hi-Touch LSIG	1SDA072010R1	
	6300	200	120	E6.2X/f 6300 Ekip G Touch LSIG	1SDA072037R1	
				E6.2X/f 6300 Ekip G Hi-Touch LSIG	1SDA072040R1	

Automatic circuit-breakers

Withdrawable version for generators



SACE Emax E1.2B-C-N-L • Mobile part of withdrawable circuit-breaker (MP)

Size	I _u	I _{cu} (440 V)	I _{cw} (1s)	Type	3 Poles		4 Poles		
					Code		Code		
E1.2B	630	42	42	E1.2B 630 Ekip G Touch LSIG	1SDA072057R1		1SDA072687R1		
				E1.2B 630 Ekip G Hi-Touch LSIG	1SDA072060R1		1SDA072690R1		
	800	42	42	E1.2B 800 Ekip G Touch LSIG	1SDA072097R1		1SDA072727R1		
				E1.2B 800 Ekip G Hi-Touch LSIG	1SDA072100R1		1SDA072730R1		
	1000	42	42	E1.2B 1000 Ekip G Touch LSIG	1SDA072137R1		1SDA072767R1		
				E1.2B 1000 Ekip G Hi-Touch LSIG	1SDA072140R1		1SDA072770R1		
	1250	42	42	E1.2B 1250 Ekip G Touch LSIG	1SDA072177R1		1SDA072807R1		
				E1.2B 1250 Ekip G Hi-Touch LSIG	1SDA072180R1		1SDA072810R1		
	1600	42	42	E1.2B 1600 Ekip G Touch LSIG	1SDA072217R1		1SDA072847R1		
				E1.2B 1600 Ekip G Hi-Touch LSIG	1SDA072220R1		1SDA072850R1		
	E1.2C	630	50	42	E1.2C 630 Ekip G Touch LSIG	1SDA072067R1		1SDA072697R1	
					E1.2C 630 Ekip G Hi-Touch LSIG	1SDA072070R1		1SDA072700R1	
800		50	42	E1.2C 800 Ekip G Touch LSIG	1SDA072107R1		1SDA072737R1		
				E1.2C 800 Ekip G Hi-Touch LSIG	1SDA072110R1		1SDA072740R1		
1000		50	42	E1.2C 1000 Ekip G Touch LSIG	1SDA072147R1		1SDA072777R1		
				E1.2C 1000 Ekip G Hi-Touch LSIG	1SDA072150R1		1SDA072780R1		
1250		50	42	E1.2C 1250 Ekip G Touch LSIG	1SDA072187R1		1SDA072817R1		
				E1.2C 1250 Ekip G Hi-Touch LSIG	1SDA072190R1		1SDA072820R1		
1600		50	42	E1.2C 1600 Ekip G Touch LSIG	1SDA072227R1		1SDA072857R1		
				E1.2C 1600 Ekip G Hi-Touch LSIG	1SDA072230R1		1SDA072860R1		
E1.2N		250	66	50	E1.2N 250 Ekip G Touch LSIG	1SDA072047R1		1SDA072677R1	
					E1.2N 250 Ekip G Hi-Touch LSIG	1SDA072050R1		1SDA072680R1	
	630	66	50	E1.2N 630 Ekip G Touch LSIG	1SDA072077R1		1SDA072707R1		
				E1.2N 630 Ekip G Hi-Touch LSIG	1SDA072080R1		1SDA072710R1		
	800	66	50	E1.2N 800 Ekip G Touch LSIG	1SDA072117R1		1SDA072747R1		
				E1.2N 800 Ekip G Hi-Touch LSIG	1SDA072120R1		1SDA072750R1		
	1000	66	50	E1.2N 1000 Ekip G Touch LSIG	1SDA072157R1		1SDA072787R1		
				E1.2N 1000 Ekip G Hi-Touch LSIG	1SDA072160R1		1SDA072790R1		
	1250	66	50	E1.2N 1250 Ekip G Touch LSIG	1SDA072197R1		1SDA072827R1		
				E1.2N 1250 Ekip G Hi-Touch LSIG	1SDA072200R1		1SDA072830R1		
	1600	66	50	E1.2N 1600 Ekip G Touch LSIG	1SDA072237R1		1SDA072867R1		
				E1.2N 1600 Ekip G Hi-Touch LSIG	1SDA072240R1		1SDA072870R1		
E1.2L	630	130	15	E1.2L 630 Ekip G Touch LSIG	1SDA072087R1		1SDA072717R1		
				E1.2L 630 Ekip G Hi-Touch LSIG	1SDA072090R1		1SDA072720R1		
	800	130	15	E1.2L 800 Ekip G Touch LSIG	1SDA072127R1		1SDA072757R1		
				E1.2L 800 Ekip G Hi-Touch LSIG	1SDA072130R1		1SDA072760R1		
	1000	130	15	E1.2L 1000 Ekip G Touch LSIG	1SDA072167R1		1SDA072797R1		
				E1.2L 1000 Ekip G Hi-Touch LSIG	1SDA072170R1		1SDA072800R1		
	1250	130	15	E1.2L 1250 Ekip G Touch LSIG	1SDA072207R1		1SDA072837R1		
				E1.2L 1250 Ekip G Hi-Touch LSIG	1SDA072210R1		1SDA072840R1		



1SDC200066F001

SACE Emax E2.2B-N-S-H • Mobile part of withdrawable circuit-breaker (MP)

Size	Iu	Icu (440 V)	Icw (1s)	Type	3 Poles		4 Poles		
					Code		Code		
E2.2B	1600	42	42	E2.2B 1600 Ekip G Touch LSIG	1SDA072337R1		1SDA072967R1		
				E2.2B 1600 Ekip G Hi-Touch LSIG	1SDA072340R1		1SDA072970R1		
	2000	42	42	E2.2B 2000 Ekip G Touch LSIG	1SDA072377R1		1SDA073007R1		
				E2.2B 2000 Ekip G Hi-Touch LSIG	1SDA072380R1		1SDA073010R1		
E2.2N	800	66	66	E2.2N 800 Ekip G Touch LSIG	1SDA072247R1		1SDA072877R1		
				E2.2N 800 Ekip G Hi-Touch LSIG	1SDA072250R1		1SDA072880R1		
	1000	66	66	E2.2N 1000 Ekip G Touch LSIG	1SDA072277R1		1SDA072907R1		
				E2.2N 1000 Ekip G Hi-Touch LSIG	1SDA072280R1		1SDA072910R1		
	1250	66	66	E2.2N 1250 Ekip G Touch LSIG	1SDA072307R1		1SDA072937R1		
				E2.2N 1250 Ekip G Hi-Touch LSIG	1SDA072310R1		1SDA072940R1		
	1600	66	66	E2.2N 1600 Ekip G Touch LSIG	1SDA072347R1		1SDA072977R1		
				E2.2N 1600 Ekip G Hi-Touch LSIG	1SDA072350R1		1SDA072980R1		
	2000	66	66	E2.2N 2000 Ekip G Touch LSIG	1SDA072387R1		1SDA073017R1		
				E2.2N 2000 Ekip G Hi-Touch LSIG	1SDA072390R1		1SDA073020R1		
	2500	66	66	E2.2N 2500 Ekip G Touch LSIG	1SDA072417R1		1SDA073047R1		
				E2.2N 2500 Ekip G Hi-Touch LSIG	1SDA072420R1		1SDA073050R1		
	E2.2S	250	85	66	E2.2S 250 Ekip G Touch LSIG	1SDA073654R1		1SDA073664R1	
					E2.2S 250 Ekip G Hi-Touch LSIG	1SDA073657R1		1SDA073667R1	
800		85	66	E2.2S 800 Ekip G Touch LSIG	1SDA072257R1		1SDA072887R1		
				E2.2S 800 Ekip G Hi-Touch LSIG	1SDA072260R1		1SDA072890R1		
1000		85	66	E2.2S 1000 Ekip G Touch LSIG	1SDA072287R1		1SDA072917R1		
				E2.2S 1000 Ekip G Hi-Touch LSIG	1SDA072290R1		1SDA072920R1		
1250		85	66	E2.2S 1250 Ekip G Touch LSIG	1SDA072317R1		1SDA072947R1		
				E2.2S 1250 Ekip G Hi-Touch LSIG	1SDA072320R1		1SDA072950R1		
1600		85	66	E2.2S 1600 Ekip G Touch LSIG	1SDA072357R1		1SDA072987R1		
				E2.2S 1600 Ekip G Hi-Touch LSIG	1SDA072360R1		1SDA072990R1		
2000		85	66	E2.2S 2000 Ekip G Touch LSIG	1SDA072397R1		1SDA073027R1		
				E2.2S 2000 Ekip G Hi-Touch LSIG	1SDA072400R1		1SDA073030R1		
2500		85	66	E2.2S 2500 Ekip G Touch LSIG	1SDA072427R1		1SDA073057R1		
				E2.2S 2500 Ekip G Hi-Touch LSIG	1SDA072430R1		1SDA073060R1		
E2.2H		800	100	85	E2.2H 800 Ekip G Touch LSIG	1SDA072267R1		1SDA072897R1	
					E2.2H 800 Ekip G Hi-Touch LSIG	1SDA072270R1		1SDA072900R1	
		1000	100	85	E2.2H 1000 Ekip G Touch LSIG	1SDA072297R1		1SDA072927R1	
					E2.2H 1000 Ekip G Hi-Touch LSIG	1SDA072300R1		1SDA072930R1	
	1250	100	85	E2.2H 1250 Ekip G Touch LSIG	1SDA072327R1		1SDA072957R1		
				E2.2H 1250 Ekip G Hi-Touch LSIG	1SDA072330R1		1SDA072960R1		
	1600	100	85	E2.2H 1600 Ekip G Touch LSIG	1SDA072367R1		1SDA072997R1		
				E2.2H 1600 Ekip G Hi-Touch LSIG	1SDA072370R1		1SDA073000R1		
	2000	100	85	E2.2H 2000 Ekip G Touch LSIG	1SDA072407R1		1SDA073037R1		
				E2.2H 2000 Ekip G Hi-Touch LSIG	1SDA072410R1		1SDA073040R1		
	2500	100	85	E2.2H 2500 Ekip G Touch LSIG	1SDA072437R1		1SDA073067R1		
				E2.2H 2500 Ekip G Hi-Touch LSIG	1SDA072440R1		1SDA073070R1		

Automatic circuit-breakers

Withdrawable version for generators



SACE Emax E4.2N-S-H-V • Mobile part of withdrawable circuit-breaker (MP)

Size	Iu	Icu (440 V)	Icw (1s)	Type	3 Poles		4 Poles	
					Code		Code	
E4.2N	3200	66	66	E4.2N 3200 Ekip G Touch LSIG	1SDA072497R1		1SDA073127R1	
				E4.2N 3200 Ekip G Hi-Touch LSIG	1SDA072500R1		1SDA073130R1	
	4000	66	66	E4.2N 4000 Ekip G Touch LSIG	1SDA072547R1		1SDA073177R1	
				E4.2N 4000 Ekip G Hi-Touch LSIG	1SDA072550R1		1SDA073180R1	
E4.2S	3200	85	66	E4.2S 3200 Ekip G Touch LSIG	1SDA072507R1		1SDA073137R1	
				E4.2S 3200 Ekip G Hi-Touch LSIG	1SDA072510R1		1SDA073140R1	
	4000	85	66	E4.2S 4000 Ekip G Touch LSIG	1SDA072557R1		1SDA073187R1	
				E4.2S 4000 Ekip G Hi-Touch LSIG	1SDA072560R1		1SDA073190R1	
E4.2H	3200	100	85	E4.2H 3200 Ekip G Touch LSIG	1SDA072517R1		1SDA073147R1	
				E4.2H 3200 Ekip G Hi-Touch LSIG	1SDA072520R1		1SDA073150R1	
	4000	100	85	E4.2H 4000 Ekip G Touch LSIG	1SDA072567R1		1SDA073197R1	
				E4.2H 4000 Ekip G Hi-Touch LSIG	1SDA072570R1		1SDA073200R1	
E4.2V	2000	150	100	E4.2V 2000 Ekip G Touch LSIG	1SDA072457R1		1SDA073087R1	
				E4.2V 2000 Ekip G Hi-Touch LSIG	1SDA072460R1		1SDA073090R1	
	2500	150	100	E4.2V 2500 Ekip G Touch LSIG	1SDA072477R1		1SDA073107R1	
				E4.2V 2500 Ekip G Hi-Touch LSIG	1SDA072480R1		1SDA073110R1	
	3200	150	100	E4.2V 3200 Ekip G Touch LSIG	1SDA072527R1		1SDA073157R1	
				E4.2V 3200 Ekip G Hi-Touch LSIG	1SDA072530R1		1SDA073160R1	
	4000	150	100	E4.2V 4000 Ekip G Touch LSIG	1SDA072577R1		1SDA073207R1	
				E4.2V 4000 Ekip G Hi-Touch LSIG	1SDA072580R1		1SDA073210R1	



1SDC20066R001

SACE Emax E6.2H-V-X • Mobile part of withdrawable circuit-breaker (MP)

Size	Iu	Icu (440 V)	Icw (1s)	Type	3 Poles	4 Poles
					Code	Code
E6.2H	4000	100	100	E6.2H 4000 Ekip G Touch LSIG	1SDA072587R1	1SDA073217R1
				E6.2H 4000 Ekip G Hi-Touch LSIG	1SDA072590R1	1SDA073220R1
	5000	100	100	E6.2H 5000 Ekip G Touch LSIG	1SDA072617R1	1SDA073247R1
				E6.2H 5000 Ekip G Hi-Touch LSIG	1SDA072620R1	1SDA073250R1
	6300	100	100	E6.2H 6300 Ekip G Touch LSIG	1SDA072647R1	1SDA073277R1
				E6.2H 6300 Ekip G Hi-Touch LSIG	1SDA072650R1	1SDA073280R1
E6.2V	4000	150	100	E6.2V 4000 Ekip G Touch LSIG	1SDA072597R1	1SDA073227R1
				E6.2V 4000 Ekip G Hi-Touch LSIG	1SDA072600R1	1SDA073230R1
	5000	150	100	E6.2V 5000 Ekip G Touch LSIG	1SDA072627R1	1SDA073257R1
				E6.2V 5000 Ekip G Hi-Touch LSIG	1SDA072630R1	1SDA073260R1
	6300	150	100	E6.2V 6300 Ekip G Touch LSIG	1SDA072657R1	1SDA073287R1
				E6.2V 6300 Ekip G Hi-Touch LSIG	1SDA072660R1	1SDA073290R1
E6.2X	4000	200	120	E6.2X 4000 Ekip G Touch LSIG	1SDA072607R1	1SDA073237R1
				E6.2X 4000 Ekip G Hi-Touch LSIG	1SDA072610R1	1SDA073240R1
	5000	200	120	E6.2X 5000 Ekip G Touch LSIG	1SDA072637R1	1SDA073267R1
				E6.2X 5000 Ekip G Hi-Touch LSIG	1SDA072640R1	1SDA073270R1
	6300	200	120	E6.2X 6300 Ekip G Touch LSIG	1SDA072667R1	1SDA073297R1
				E6.2X 6300 Ekip G Hi-Touch LSIG	1SDA072670R1	1SDA073300R1

Automatic circuit-breakers

Withdrawable version per generators



SACE Emax E6.2H-V-X/f Full size • Mobile part of withdrawable circuit-breaker (MP)

Size	Iu	Icu (440 V)	Icw (1s)	Type	4 Poles	
					Code	
E6.2H/f	4000	100	100	E6.2H/f 4000 Ekip G Touch LSIG	1SDA073307R1	
				E6.2H/f 4000 Ekip G Hi-Touch LSIG	1SDA073310R1	
	5000	100	100	E6.2H/f 5000 Ekip G Touch LSIG	1SDA073337R1	
				E6.2H/f 5000 Ekip G Hi-Touch LSIG	1SDA073340R1	
	6300	100	100	E6.2H/f 6300 Ekip G Touch LSIG	1SDA073367R1	
				E6.2H/f 6300 Ekip G Hi-Touch LSIG	1SDA073370R1	
E6.2V/f	4000	150	100	E6.2V/f 4000 Ekip G Touch LSIG	1SDA073317R1	
				E6.2V/f 4000 Ekip G Hi-Touch LSIG	1SDA073320R1	
	5000	150	100	E6.2V/f 5000 Ekip G Touch LSIG	1SDA073347R1	
				E6.2V/f 5000 Ekip G Hi-Touch LSIG	1SDA073350R1	
	6300	150	100	E6.2V/f 6300 Ekip G Touch LSIG	1SDA073377R1	
				E6.2V/f 6300 Ekip G Hi-Touch LSIG	1SDA073380R1	
E6.2X/f	4000	200	120	E6.2X/f 4000 Ekip G Touch LSIG	1SDA073327R1	
				E6.2X/f 4000 Ekip G Hi-Touch LSIG	1SDA073330R1	
	5000	200	120	E6.2X/f 5000 Ekip G Touch LSIG	1SDA073357R1	
				E6.2X/f 5000 Ekip G Hi-Touch LSIG	1SDA073360R1	
	6300	200	120	E6.2X/f 6300 Ekip G Touch LSIG	1SDA073387R1	
				E6.2X/f 6300 Ekip G Hi-Touch LSIG	1SDA073390R1	

Switch-disconnectors

Fixed version



1SDC200668F001

SACE Emax E1.2B-N/MS • Fixed terminals (F)

Size	Iu	Icw (1s)	Type	3 Poles		4 Poles	
				Code		Code	
E1.2B/MS	630	42	E1.2B/MS 630	1SDA073392R1		1SDA073431R1	
	800	42	E1.2B/MS 800	1SDA073394R1		1SDA073433R1	
	1000	42	E1.2B/MS 1000	1SDA073396R1		1SDA073435R1	
	1250	42	E1.2B/MS 1250	1SDA073398R1		1SDA073437R1	
	1600	42	E1.2B/MS 1600	1SDA073400R1		1SDA073439R1	
E1.2N/MS	250	50	E1.2N/MS 250	1SDA073391R1		1SDA073430R1	
	630	50	E1.2N/MS 630	1SDA073393R1		1SDA073432R1	
	800	50	E1.2N/MS 800	1SDA073395R1		1SDA073434R1	
	1000	50	E1.2N/MS 1000	1SDA073397R1		1SDA073436R1	
	1250	50	E1.2N/MS 1250	1SDA073399R1		1SDA073438R1	
	1600	50	E1.2N/MS 1600	1SDA073401R1		1SDA073440R1	



1SDC200670F001

SACE Emax E2.2B-N-H/MS • Orientable rear terminals (HR)

Size	Iu	Icw (1s)	Type	3 Poles		4 Poles	
				Code		Code	
E2.2B/MS	1600	42	E2.2B/MS 1600	1SDA073408R1		1SDA073447R1	
	2000	42	E2.2B/MS 2000	1SDA073411R1		1SDA073450R1	
E2.2N/MS	800	66	E2.2N/MS 800	1SDA073402R1		1SDA073441R1	
	1000	66	E2.2N/MS 1000	1SDA073404R1		1SDA073443R1	
	1250	66	E2.2N/MS 1250	1SDA073406R1		1SDA073445R1	
	1600	66	E2.2N/MS 1600	1SDA073409R1		1SDA073448R1	
	2000	66	E2.2N/MS 2000	1SDA073412R1		1SDA073451R1	
	2500	66	E2.2N/MS 2500	1SDA073414R1		1SDA073453R1	
E2.2H/MS	800	85	E2.2H/MS 800	1SDA073403R1		1SDA073442R1	
	1000	85	E2.2H/MS 1000	1SDA073405R1		1SDA073444R1	
	1250	85	E2.2H/MS 1250	1SDA073407R1		1SDA073446R1	
	1600	85	E2.2H/MS 1600	1SDA073410R1		1SDA073449R1	
	2000	85	E2.2H/MS 2000	1SDA073413R1		1SDA073452R1	
	2500	85	E2.2H/MS 2500	1SDA073415R1		1SDA073454R1	

Switch-disconnectors

Fixed version



1SDC200871F001

SACE Emax E4.2N-H-V/MS • Orientable rear terminals (HR)

Size	Iu	Icw (1s)	Type	3 Poles		4 Poles	
				Code		Code	
E4.2N/MS	3200	66	E4.2N/MS 3200	1SDA073418R1		1SDA073457R1	
	4000	66	E4.2N/MS 4000	1SDA073421R1		1SDA073460R1	
E4.2H/MS	3200	85	E4.2H/MS 3200	1SDA073419R1		1SDA073458R1	
	4000	85	E4.2H/MS 4000	1SDA073422R1		1SDA073461R1	
E4.2V/MS	2000	100	E4.2V/MS 2000	1SDA073416R1		1SDA073455R1	
	2500	100	E4.2V/MS 2500	1SDA073417R1		1SDA073456R1	
	3200	100	E4.2V/MS 3200	1SDA073420R1		1SDA073459R1	
	4000	100	E4.2V/MS 4000	1SDA073423R1		1SDA073462R1	



1SDC200872F001

SACE Emax E6.2H-X/MS • Orientable rear terminals (HR)

Size	Iu	Icw (1s)	Type	3 Poles		4 Poles	
				Code		Code	
E6.2H/MS	4000	100	E6.2H/MS 4000	1SDA073424R1		1SDA073463R1	
	5000	100	E6.2H/MS 5000	1SDA073426R1		1SDA073465R1	
	6300	100	E6.2H/MS 6300	1SDA073428R1		1SDA073467R1	
E6.2X/MS	4000	120	E6.2X/MS 4000	1SDA073425R1		1SDA073464R1	
	5000	120	E6.2X/MS 5000	1SDA073427R1		1SDA073466R1	
	6300	120	E6.2X/MS 6300	1SDA073429R1		1SDA073468R1	



1SDC200672E001

SACE Emax E6.2H-X/MS/f Full size • Orientable rear terminals (HR)

Size	Iu	Icw (1s)	Type	4 Poles	
				Code	
E6.2H/MS/f	4000	100	E6.2H/MS/f 4000	1SDA073469R1	
	5000	100	E6.2H/MS/f 5000	1SDA073471R1	
	6300	100	E6.2H/MS/f 6300	1SDA073473R1	
E6.2X/MS/f	4000	120	E6.2X/MS/f 4000	1SDA073470R1	
	5000	120	E6.2X/MS/f 5000	1SDA073472R1	
	6300	120	E6.2X/MS/f 6300	1SDA073474R1	

Switch-disconnectors Withdrawable version



1SDC2006/3F001

SACE Emax E1.2B-N/MS • Mobile part of withdrawable circuit-breaker (MP)

Size	Iu	Icw (1s)	Type	3 Poles		4 Poles	
				Code		Code	
E1.2B/MS	630	42	E1.2B/MS 630	1SDA073476R1		1SDA073515R1	
	800	42	E1.2B/MS 800	1SDA073478R1		1SDA073517R1	
	1000	42	E1.2B/MS 1000	1SDA073480R1		1SDA073519R1	
	1250	42	E1.2B/MS 1250	1SDA073482R1		1SDA073521R1	
	1600	42	E1.2B/MS 1600	1SDA073484R1		1SDA073523R1	
E1.2N/MS	250	50	E1.2N/MS 250	1SDA073475R1		1SDA073514R1	
	630	50	E1.2N/MS 630	1SDA073477R1		1SDA073516R1	
	800	50	E1.2N/MS 800	1SDA073479R1		1SDA073518R1	
	1000	50	E1.2N/MS 1000	1SDA073481R1		1SDA073520R1	
	1250	50	E1.2N/MS 1250	1SDA073483R1		1SDA073522R1	
	1600	50	E1.2N/MS 1600	1SDA073485R1		1SDA073524R1	



1SDC2006/4F001

SACE Emax E2.2B-N-H/MS • Mobile part of withdrawable circuit-breaker (MP)

Size	Iu	Icw (1s)	Type	3 Poles		4 Poles	
				Code		Code	
E2.2B/MS	1600	42	E2.2B/MS 1600	1SDA073492R1		1SDA073531R1	
	2000	42	E2.2B/MS 2000	1SDA073495R1		1SDA073534R1	
E2.2N/MS	800	66	E2.2N/MS 800	1SDA073486R1		1SDA073525R1	
	1000	66	E2.2N/MS 1000	1SDA073488R1		1SDA073527R1	
	1250	66	E2.2N/MS 1250	1SDA073490R1		1SDA073529R1	
	1600	66	E2.2N/MS 1600	1SDA073493R1		1SDA073532R1	
	2000	66	E2.2N/MS 2000	1SDA073496R1		1SDA073535R1	
	2500	66	E2.2N/MS 2500	1SDA073498R1		1SDA073537R1	
E2.2H/MS	800	85	E2.2H/MS 800	1SDA073487R1		1SDA073526R1	
	1000	85	E2.2H/MS 1000	1SDA073489R1		1SDA073528R1	
	1250	85	E2.2H/MS 1250	1SDA073491R1		1SDA073530R1	
	1600	85	E2.2H/MS 1600	1SDA073494R1		1SDA073533R1	
	2000	85	E2.2H/MS 2000	1SDA073497R1		1SDA073536R1	
	2500	85	E2.2H/MS 2500	1SDA073499R1		1SDA073538R1	



1SDC200675F001

SACE Emax E4.2N-H-V/MS • Mobile part of withdrawable circuit-breaker (MP)

Size	Iu	Icw (1s)	Type	3 Poles		4 Poles	
				Code		Code	
E4.2N/MS	3200	66	E4.2N/MS 3200	1SDA073502R1		1SDA073541R1	
	4000	66	E4.2N/MS 4000	1SDA073505R1		1SDA073544R1	
E4.2H/MS	3200	85	E4.2H/MS 3200	1SDA073503R1		1SDA073542R1	
	4000	85	E4.2H/MS 4000	1SDA073506R1		1SDA073545R1	
E4.2V/MS	2000	100	E4.2V/MS 2000	1SDA073500R1		1SDA073539R1	
	2500	100	E4.2V/MS 2500	1SDA073501R1		1SDA073540R1	
	3200	100	E4.2V/MS 3200	1SDA073504R1		1SDA073543R1	
	4000	100	E4.2V/MS 4000	1SDA073507R1		1SDA073546R1	



1SDC200678F001

SACE Emax E6.2H-X/MS • Mobile part of withdrawable circuit-breaker (MP)

Size	Iu	Icw (1s)	Type	3 Poles		4 Poles	
				Code		Code	
E6.2H/MS	4000	100	E6.2H/MS 4000	1SDA073508R1		1SDA073547R1	
	5000	100	E6.2H/MS 5000	1SDA073510R1		1SDA073549R1	
	6300	100	E6.2H/MS 6300	1SDA073512R1		1SDA073551R1	
E6.2X/MS	4000	120	E6.2X/MS 4000	1SDA073509R1		1SDA073548R1	
	5000	120	E6.2X/MS 5000	1SDA073511R1		1SDA073550R1	
	6300	120	E6.2X/MS 6300	1SDA073513R1		1SDA073552R1	

SACE Emax E6.2H-X/MS/f Full size • Mobile part of withdrawable circuit-breaker (MP)

Size	Iu	Icw (1s)	Type	4 Poles	
				Code	
E6.2H/MS/f	4000	100	E6.2H/MS/f 4000	1SDA073553R1	
	5000	100	E6.2H/MS/f 5000	1SDA073555R1	
	6300	100	E6.2H/MS/f 6300	1SDA073557R1	
E6.2X/MS/f	4000	120	E6.2X/MS/f 4000	1SDA073554R1	
	5000	120	E6.2X/MS/f 5000	1SDA073556R1	
	6300	120	E6.2X/MS/f 6300	1SDA073558R1	

Automatic circuit-breakers and switch-disconnectors

Version for applications up to 1150V AC

Size	I _u	I _{cu} (1150 V)	I _{cw} (1s)	Type	3 Poles		4 Poles	
					Code		Code	
E1.2N/E	630	25	25	E1.2N/E 630 Upgrade Kit 1150V AC	1SDA074316R1		1SDA074321R1	
E1.2N/E	800	25	25	E1.2N/E 800 Upgrade Kit 1150V AC	1SDA074317R1		1SDA074322R1	
E1.2N/E	1000	25	25	E1.2N/E 1000 Upgrade Kit 1150V AC	1SDA074318R1		1SDA074323R1	
E1.2N/E	1250	25	25	E1.2N/E 1250 Upgrade Kit 1150V AC	1SDA074319R1		1SDA074324R1	
E1.2N/E	1600	25	25	E1.2N/E 1600 Upgrade Kit 1150V AC	1SDA074320R1		1SDA074325R1	
E2.2H/E	800	30	30	E2.2H/E 800 Upgrade Kit 1150V AC	1SDA074326R1		1SDA074332R1	
E2.2H/E	1000	30	30	E2.2H/E 1000 Upgrade Kit 1150V AC	1SDA074327R1		1SDA074333R1	
E2.2H/E	1250	30	30	E2.2H/E 1250 Upgrade Kit 1150V AC	1SDA074328R1		1SDA074334R1	
E2.2H/E	1600	30	30	E2.2H/E 1600 Upgrade Kit 1150V AC	1SDA074329R1		1SDA074335R1	
E2.2H/E	2000	30	30	E2.2H/E 2000 Upgrade Kit 1150V AC	1SDA074330R1		1SDA074336R1	
E2.2H/E	2500	30	30	E2.2H/E 2500 Upgrade Kit 1150V AC	1SDA074331R1		1SDA074337R1	
E4.2H/E	3200	50	50	E4.2H/E 3200 Upgrade Kit 1150V AC	1SDA074338R1		1SDA074340R1	
E4.2H/E	4000	50	50	E4.2H/E 4000 Upgrade Kit 1150V AC	1SDA074339R1		1SDA074341R1	
E6.2X/E	4000	65	65	E6.2X/E 4000 Upgrade Kit 1150V AC	1SDA074342R1		1SDA074345R1	
E6.2X/E	5000	65	65	E6.2X/E 5000 Upgrade Kit 1150V AC	1SDA074343R1		1SDA074346R1	
E6.2X/E	6300	65	65	E6.2X/E 6300 Upgrade Kit 1150V AC	1SDA074344R1		1SDA074347R1	

Switch-disconnectors

Fixed version for applications up to 1000V DC

Size	Iu	Icu (1000 V)	Icw (1s)	Type	3 Poles		4 Poles	
					Code		Code	
E1.2N/DC/MS	800			E1.2N/DC/MS 800A 750-1000V DC	1SDA074381R1		1SDA074382R1	
E1.2N/DC/MS	1250			E1.2N/DC/MS 1250A 750-1000V DC	1SDA074383R1		1SDA074384R1	
E2.2S/DC/MS	1250			E2.2S/DC/MS 1250A 750-1000V DC	1SDA074389R1		1SDA074390R1	
E2.2S/DC/MS	1600			E2.2S/DC/MS 1600A 750-1000V DC	1SDA074391R1		1SDA074392R1	
E2.2S/DC/MS	2000			E2.2S/DC/MS 2000A 750-1000V DC	1SDA074393R1		1SDA074394R1	
E2.2S/DC/MS	2500			E2.2S/DC/MS 2500A 750-1000V DC	1SDA074395R1		1SDA074396R1	
E4.2H/DC/MS	1250			E4.2H/DC/MS 1250A 750-1000V DC	1SDA074405R1		1SDA074406R1	
E4.2H/DC/MS	1600			E4.2H/DC/MS 1600A 750-1000V DC	1SDA074407R1		1SDA074408R1	
E4.2H/DC/MS	2000			E4.2H/DC/MS 2000A 750-1000V DC	1SDA074409R1		1SDA074410R1	
E4.2H/DC/MS	2500			E4.2H/DC/MS 2500A 750-1000V DC	1SDA074411R1		1SDA074412R1	
E4.2H/DC/MS	3200			E4.2H/DC/MS 3200A 750-1000V DC	1SDA074413R1		1SDA074414R1	
E4.2H/DC/MS	4000			E4.2H/DC/MS 4000A 750-1000V DC	1SDA074415R1		1SDA074416R1	
E6.2X/DC/MS	4000			E6.2X/DC/MS 4000A 750-1000V DC	1SDA074429R1		1SDA074430R1	
E6.2X/DC/MS	5000			E6.2X/DC/MS 5000A 750-1000V DC	1SDA074431R1		1SDA074432R1	
E6.2X/DC/MS	6300			E6.2X/DC/MS 6300A 750-1000V DC	1SDA074433R1		1SDA074434R1	

Switch-disconnectors

Withdrawable version for applications up to 1000V DC

Withdrawable version - Mobile part

Size	I _u	I _{cu} (1000 V)	I _{cw} (1s)	Type	3 Poles		4 Poles	
					Code		Code	
E1.2N/DC/MS	800			E1.2N/DC/MS 800A 750-1000VDC	1SDA074385R1		1SDA074386R1	
E1.2N/DC/MS	1250			E1.2N/DC/MS 1250A 750-1000VDC	1SDA074387R1		1SDA074388R1	
E2.2S/DC/MS	1250			E2.2S/DC/MS 1250A 750-1000VDC	1SDA074397R1		1SDA074398R1	
E2.2S/DC/MS	1600			E2.2S/DC/MS 1600A 750-1000VDC	1SDA074399R1		1SDA074400R1	
E2.2S/DC/MS	2000			E2.2S/DC/MS 2000A 750-1000VDC	1SDA074401R1		1SDA074402R1	
E2.2S/DC/MS	2500			E2.2S/DC/MS 2500A 750-1000VDC	1SDA074403R1		1SDA074404R1	
E4.2H/DC/MS	1250			E4.2H/DC/MS 1250A 750-1000VDC	1SDA074417R1		1SDA074418R1	
E4.2H/DC/MS	1600			E4.2H/DC/MS 1600A 750-1000VDC	1SDA074419R1		1SDA074420R1	
E4.2H/DC/MS	2000			E4.2H/DC/MS 2000A 750-1000VDC	1SDA074421R1		1SDA074422R1	
E4.2H/DC/MS	2500			E4.2H/DC/MS 2500A 750-1000VDC	1SDA074423R1		1SDA074424R1	
E4.2H/DC/MS	3200			E4.2H/DC/MS 3200A 750-1000VDC	1SDA074425R1		1SDA074426R1	
E4.2H/DC/MS	4000			E4.2H/DC/MS 4000A 750-1000VDC	1SDA074427R1		1SDA074428R1	
E6.2X/DC/MS	4000			E6.2X/DC/MS 4000A 750-1000VDC	1SDA074435R1		1SDA074436R1	
E6.2X/DC/MS	5000			E6.2X/DC/MS 5000A 750-1000VDC	1SDA074437R1		1SDA074438R1	
E6.2X/DC/MS	6300			E6.2X/DC/MS 6300A 750-1000VDC	1SDA074439R1		1SDA074440R1	

Withdrawable version - Fixed part

Size	I _u	Type of terminal	Type	3 Poles		4 Poles	
				Code		Code	
E1.2	1600	HR - HR	E1.2DC W FP I _u =1600 HR HR	1SDA073923R1		1SDA073924R1	
E2.2	2000	HR - HR	E2.2DC W FP I _u =2000 HR HR	1SDA073925R1		1SDA073926R1	
E2.2	2500	HR - HR	E2.2DC W FP I _u =2500 HR HR	1SDA073927R1		1SDA073928R1	
E4.2	3200	HR - HR	E4.2DC W FP I _u =3200 HR HR	1SDA073929R1		1SDA073930R1	
E4.2 / E4.2V	4000	HR - HR	E4.2DC W FP I _u =4000 or V HR HR version	1SDA073931R1		1SDA073932R1	
E6.2	5000	HR - HR	E6.2DC W FP I _u =5000 HR HR	1SDA073933R1			
E6.2/f	5000	HR - HR	E6.2DC W FP I _u =5000 HR HR			1SDA073935R1	
E6.2 / E6.2X	6300	HR - HR	E6.2DC W FP I _u =6300 HR HR	1SDA073936R1			
E6.2/f / E6.2X/f	6300	HR - HR	E6.2DC W FP I _u =6300 HR HR			1SDA073938R1	

Derived versions

Sectionalizing truck - CS

Size	lu	Type	3 poles	4 poles
			Code	Code
E2.2/CS	2500	E2.2/CS 2500 MP 3p	1SDA074348R1	1SDA074349R1
E4.2/CS	4000	E4.2/CS 4000 MP 3p	1SDA074350R1	1SDA074351R1
E6.2/CS	6300	E6.2/CS 6300 MP 3p	1SDA074352R1	1SDA074353R1

Earthing truck - MT

Size	lu	Type	3 poles	4 poles
			Code	Code
E2.2 MT	2500	E2.2MT 2500 MP Earth connection from upper terminals	1SDA074354R1	1SDA074355R1
E4.2 MT	4000	E4.2MT 4000 MP Earth connection from upper terminals	1SDA074356R1	1SDA074357R1
E6.2 MT	6300	E6.2MT 6300 MP Earth connection from upper terminals	1SDA074358R1	1SDA074359R1
E2.2 MT	2500	E2.2MT 2500 MP Earth connection from lower terminals	1SDA074360R1	1SDA074361R1
E4.2 MT	4000	E4.2MT 4000 MP Earth connection from lower terminals	1SDA074362R1	1SDA074363R1
E6.2 MT	6300	E6.2MT 6300 MP Earth connection from lower terminals	1SDA074364R1	1SDA074365R1

Earthing switch with making capacity - MTP

Size	lu	Type	3 poles	4 poles
			Code	Code
E2.2 MTP	2500	E2.2MTP 2500 MP Earth connection from upper terminals	1SDA074366R1	1SDA074367R1
E4.2 MTP	4000	E4.2MTP 4000 MP Earth connection from upper terminals	1SDA074368R1	1SDA074369R1
E6.2 MTP	6300	E6.2MTP 6300 MP Earth connection from upper terminals	1SDA074370R1	1SDA074371R1
E2.2 MTP	2500	E2.2MTP 2500 MP Earth connection from lower terminals	1SDA074372R1	1SDA074373R1
E4.2 MTP	4000	E4.2MTP 4000 MP Earth connection from lower terminals	1SDA074374R1	1SDA074375R1
E6.2 MTP	6300	E6.2MTP 6300 MP Earth connection from lower terminals	1SDA074376R1	1SDA074377R1

Accessories for MT and MTP

Size	Type	Code
E2.2	Grounding clamp PF E2.2 for MT/MTP	1SDA074378R1
E4.2	Grounding clamp PF E4.2 for MT/MTP	1SDA074379R1
E6.2	Grounding clamp PF E6.2 for MT/MTP	1SDA074380R1

Fixed or Mobile Part with neutral on right side

Size	Type	Code
E1.2...E6.2	Installation with neutral on right side sequence L1,L2,L3,N	1SDA076153R1

Fixed parts



Size	Performance	Iu range	Type of terminal	Type	3 Poles	4 Poles
					Code	Code
E1.2	B, C, N, L	250 - 1600	HR - HR	E1.2 W FP Iu=1600 HR HR	1SDA073907R1	1SDA073908R1
E2.2	B, N, S, H	250 - 2000	HR - HR	E2.2 W FP Iu=2000 HR HR	1SDA073909R1	1SDA073910R1
E2.2	N, S, H	2500	HR - HR	E2.2 W FP Iu=2500 HR HR	1SDA073911R1	1SDA073912R1
E4.2	N, S, H	3200	HR - HR	E4.2 W FP Iu=3200 HR HR	1SDA073913R1	1SDA073914R1
E4.2	N, S, H	4000	HR - HR	E4.2 W FP Iu=4000 or V version HR HR	1SDA073915R1	1SDA073916R1
E4.2	V	2000-4000	HR - HR	E4.2 W FP Iu=4000 or V version HR HR	1SDA073915R1	1SDA073916R1
E6.2	H, V	4000-5000	HR - HR	E6.2 W FP Iu=5000 HR HR	1SDA073917R1	1SDA073918R1
E6.2/f	H, V	4000-5000	HR - HR	E6.2 W FP Iu=5000 HR HR		1SDA073919R1
E6.2*	H, V, X	4000-6300	HR - HR	E6.2X W FP Iu=6300 or X version HR HR	1SDA073920R1	1SDA073921R1
E6.2/f*	H, V, X	4000-6300	HR - HR	E6.2X W FP Iu=6300 or X version HR HR		1SDA073922R1

*These types of fixed parts are suitable for all types of E6.2 mobile parts from 4000A to 6300A (all Icu performance level)

Accessories

Electrical accessories



First and second opening release - YO

Size	Type	Code
E1.2..E6.2	YO E1.2..E6.2 24V AC/DC	1SDA073668R1
E1.2..E6.2	YO E1.2..E6.2 30V AC/DC	1SDA073669R1
E1.2..E6.2	YO E1.2..E6.2 48V AC/DC	1SDA073670R1
E1.2..E6.2	YO E1.2..E6.2 60V AC/DC	1SDA073671R1
E1.2..E6.2	YO E1.2..E6.2 110-120V AC/DC	1SDA073672R1
E1.2..E6.2	YO E1.2..E6.2 120-127V AC/DC	1SDA073673R1
E1.2..E6.2	YO E1.2..E6.2 220-240V AC/DC	1SDA073674R1
E1.2..E6.2	YO E1.2..E6.2 240-250V AC/DC	1SDA073675R1
E1.2..E6.2	YO E1.2..E6.2 380-400V AC	1SDA073677R1
E1.2..E6.2	YO E1.2..E6.2 415-440V AC	1SDA073678R1
E1.2..E6.2	YO E1.2..E6.2 480-500V AC	1SDA073679R1

First and second closing release- YC

Size	Type	Code
E1.2..E6.2	YC E1.2..E6.2 24V AC/DC	1SDA073681R1
E1.2..E6.2	YC E1.2..E6.2 30V AC/DC	1SDA073682R1
E1.2..E6.2	YC E1.2..E6.2 48V AC/DC	1SDA073683R1
E1.2..E6.2	YC E1.2..E6.2 60V AC/DC	1SDA073684R1
E1.2..E6.2	YC E1.2..E6.2 110-120V AC/DC	1SDA073685R1
E1.2..E6.2	YC E1.2..E6.2 120-127V AC/DC	1SDA073686R1
E1.2..E6.2	YC E1.2..E6.2 220-240V AC/DC	1SDA073687R1
E1.2..E6.2	YC E1.2..E6.2 240-250V AC/DC	1SDA073688R1
E1.2..E6.2	YC E1.2..E6.2 380-400V AC	1SDA073690R1
E1.2..E6.2	YC E1.2..E6.2 415-440V AC	1SDA073691R1
E1.2..E6.2	YC E1.2..E6.2 480-500V AC	1SDA073692R1

YO/YC test unit

Size	Type	Code
E1.2...E6.2	YO/YC test unit E1.2...E6.2*	1SDA050228R1

*Only as loose part

Undervoltage release - YU

Size	Type	Code
E1.2..E6.2	YU E1.2..E6.2 24V AC/DC	1SDA073694R1
E1.2..E6.2	YU E1.2..E6.2 30V AC/DC	1SDA073695R1
E1.2..E6.2	YU E1.2..E6.2 48V AC/DC	1SDA073696R1
E1.2..E6.2	YU E1.2..E6.2 60V AC/DC	1SDA073697R1
E1.2..E6.2	YU E1.2..E6.2 110-120V AC/DC	1SDA073698R1
E1.2..E6.2	YU E1.2..E6.2 120-127V AC/DC	1SDA073699R1
E1.2..E6.2	YU E1.2..E6.2 220-240V AC/DC	1SDA073700R1
E1.2..E6.2	YU E1.2..E6.2 240-250V AC/DC	1SDA073701R1
E1.2..E6.2	YU E1.2..E6.2 380-400V AC	1SDA073703R1
E1.2..E6.2	YU E1.2..E6.2 415-440V AC	1SDA073704R1
E1.2..E6.2	YU E1.2..E6.2 480-500V AC	1SDA073705R1

Electronic time-delay device for undervoltage release - UVD

Size	Type	Code
E1.2...E6.2	24...30V DC	1SDA038316R1
E1.2...E6.2	48V AC/DC	1SDA038317R1
E1.2...E6.2	60V AC/DC	1SDA038318R1
E1.2...E6.2	110...127V AC/DC	1SDA038319R1
E1.2...E6.2	220...250V AC/DC	1SDA038320R1

Accessories

Electrical accessories

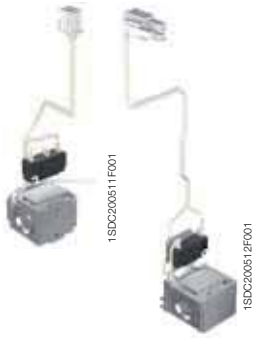

Remote Reset - YR

Size	Type	Code
E1.2	YR 24V AC/DC E1.2	1SDA073744R1
E1.2	YR 110V AC/DC E1.2	1SDA073745R1
E1.2	YR 220V AC/DC E1.2	1SDA073746R1
E2.2...E6.2	YR 24V AC/DC E2.2...E6.2	1SDA073747R1
E2.2...E6.2	YR 110V AC/DC E2.2...E6.2 *	1SDA073748R1
E2.2...E6.2	YR 220V AC/DC E2.2...E6.2*	1SDA073749R1

* when YR is used in DC, the activation of YR must be done with a maximum impulse time of 50ms. The YR cannot be powered permanently.

Motor - M

Size	Type	Code
E1.2	M E1.2 24-30V AC/DC+S33 M/2 250V	1SDA073708R1
E1.2	M E1.2 48-60V AC/DC+S33 M/2 250V	1SDA073709R1
E1.2	M E1.2 100-130V AC/DC+S33 M/2 250V	1SDA073710R1
E1.2	M E1.2 220-250V AC/DC+S33 M/2 250V	1SDA073711R1
E1.2	M E1.2 380-415V AC+S33 M/2 250V	1SDA073713R1
E2.2...E6.2	M E2.2...E6.2 24-30V AC/DC+S33 M/2 400V	1SDA073722R1
E2.2...E6.2	M E2.2...E6.2 48-60V AC/DC+S33 M/2 400V	1SDA073723R1
E2.2...E6.2	M E2.2...E6.2 100-130V AC/DC+S33 M/2 400V	1SDA073724R1
E2.2...E6.2	M E2.2...E6.2 220-250V AC/DC+S33 M/2 400V	1SDA073725R1
E2.2...E6.2	M E2.2...E6.2 380-415V AC+S33 M/2 400V	1SDA073727R1
E2.2...E6.2	M E2.2...E6.2 440-480V AC+S33 M/2 400V	1SDA073728R1
E1.2	M E1.2 24-30V AC/DC + S33 M/2 24V DC	1SDA073715R1
E1.2	M E1.2 48-60V AC/DC + S33 M/2 24V DC	1SDA073716R1
E1.2	M E1.2 100-130V AC/DC + S33 M/2 24V DC	1SDA073717R1
E1.2	M E1.2 220-250V AC/DC + S33 M/2 24V DC	1SDA073718R1
E1.2	M E1.2 380-415V AC + S33 M/2 24V DC	1SDA073720R1
E2.2...E6.2	M E2.2...E6.2 24-30V AC/DC + S33 M/2 24V DC	1SDA073729R1
E2.2...E6.2	M E2.2...E6.2 48-60V AC/DC + S33 M/2 24V DC	1SDA073730R1
E2.2...E6.2	M E2.2...E6.2 100-130V AC/DC + S33 M/2 24V DC	1SDA073731R1
E2.2...E6.2	M E2.2...E6.2 220-250V AC/DC + S33 M/2 24V DC	1SDA073732R1
E2.2...E6.2	M E2.2...E6.2 380-415V AC + S33 M/2 24V DC	1SDA073734R1
E2.2...E6.2	M E2.2...E6.2 440-480V AC + S33 M/2 24V DC	1SDA073735R1



9

Current sensor for neutral conductor outside the circuit-breaker

Size	Type	Code
E1.2	Ext CS N E1.2 E2.2 2000A*	1SDA073736R1
E2.2	Ext CS N E2.2 2500A*	1SDA073737R1
E4.2	Ext CS N E4.2 3200A*	1SDA073738R1
E6.2	Ext CS N E4.2 4000A E6.2 50%*	1SDA073739R1
E6.2	Ext CS N E6.2*	1SDA073740R1

*Only as loose part



Homopolar toroid for the earthing conductor of main power supply

Size	Type	Code
E1.2..E6.2	Homopolar toroid E1.2 ... E6.2 100A*	1SDA073743R1
E1.2..E6.2	Homopolar toroid E1.2 ... E6.2 250A*	1SDA076248R1
E1.2..E6.2	Homopolar toroid E1.2 ... E6.2 400A*	1SDA076249R1
E1.2..E6.2	Homopolar toroid E1.2 ... E6.2 800A*	1SDA076250R1

*Only as loose part

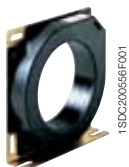

Toroid for differential protection

Size	Type	Code
E1.2 - E2.2 3p	Toroid RC E1.2, E2.2 3p*	1SDA073741R1
E2.2 4p - E4.2	Toroid RC E2.2 4p, E4.2 3p*	1SDA073742R1

*Only as loose part





1SDC200603F001



1SDC200604F001



1SDC200605F001



1SDC200606F001



1SDC200607F001



1SDC200685F001



1SDC200681F001

Open/closed auxiliary contacts - AUX

Size	Type	Code
E1.2**	AUX 4Q 400V E1.2	1SDA073750R1
E1.2	AUX 4Q 24V E1.2	1SDA073751R1
E1.2	AUX 2Q 400V + 2Q 24V E1.2	1SDA073752R1
E2.2...E6.2**	AUX 4Q 400V E2.2...E6.2	1SDA073753R1
E2.2...E6.2	AUX 4Q 24V E2.2...E6.2	1SDA073754R1
E2.2...E6.2	AUX 2Q 400V + 2Q 24V E2.2...E6.2	1SDA073755R1
E2.2...E6.2	AUX 6Q 400V E2.2...E6.2	1SDA073756R1
E2.2...E6.2	AUX 6Q 24V E2.2...E6.2	1SDA073757R1
E2.2...E6.2	AUX 3Q 400V AC + 3Q 24V DC E2.2...E6.2	1SDA075973R1
E1.2	AUX 15Q 400V E1.2 *	1SDA073758R1
E1.2	AUX 15Q 24V E1.2 *	1SDA073759R1
E2.2...E6.2	AUX 15Q 400V (for fixed/withdrawable with signalling in racked in) E2.2..E6.2 *	1SDA073760R1
E2.2...E6.2	AUX 15Q 24V (for fixed/withdrawable with signalling in racked in) E2.2..E6.2 *	1SDA073761R1
E2.2...E6.2	AUX 15Q 400V (for fixed/withdrawable with signalling in racked in/test isolated) E2.2..E6.2 *	1SDA073846R1
E2.2...E6.2	AUX 15Q 24V (for fixed/withdrawable with signalling in racked in/test isolated) E2.2..E6.2 *	1SDA073847R1

* not compatible with mechanical locks on compartment doors or mechanical interlocks.

For E1.2 you need to order also one of the following items:

Plate for fixed	1SDA062129R1
Plate for fixed - on bottom plate	1SDA062130R1
Plate for withdrawable	1SDA062131R1

** Standard supply with automatic circuit breakers

Auxiliary position contacts - AUP

Size	Type	Code
E1.2	AUP 6 contacts 400V E1.2	1SDA073762R1
E1.2	AUP 6 contacts 24V E1.2	1SDA073763R1
E2.2...E6.2	AUP 5 contacts 400V E2.2...E6.2 - left set	1SDA073764R1
E2.2...E6.2	AUP 5 contacts 24V E2.2...E6.2 - left set	1SDA073765R1
E2.2...E6.2	AUP 5 suppl. contacts 400V E2.2...E6.2 - right set	1SDA073766R1
E2.2...E6.2	AUP 5 suppl. contacts 24V E2.2...E6.2 - right set	1SDA073767R1
E1.2...E6.2	AUP Ekip auxiliary position contact E1.2..E6.2	1SDA073768R1

Ready to close signalling contact- RTC

Size	Type	Code
E1.2	RTC 250V E1.2	1SDA073770R1
E1.2	RTC 24V E1.2	1SDA073771R1
E1.2	RTC Ekip 24V E1.2	1SDA073772R1
E2.2...E6.2	RTC 250V E2.2...E6.2	1SDA073773R1
E2.2...E6.2	RTC 24V E2.2...E6.2	1SDA073774R1
E2.2...E6.2	RTC Ekip 24V E2.2...E6.2	1SDA073775R1

Contact signalling tripping of Ekip protection trip unit - S51

Size	Type	Code
E1.2	S51 250V E1.2	1SDA073776R1
E1.2	S51 24V E1.2	1SDA073777R1
E2.2...E6.2	S51 250V E2.2...E6.2	1SDA073778R1
E2.2...E6.2	S51 24V E2.2...E6.2	1SDA073779R1

Terminals for auxiliary connection

Size	Type	Code
E1.2...E6.2	Terminals 10 pcs	1SDA073906R1

Accessories

Mechanical accessories



1SDC200524F001



1SDC200516F001



1SDC200516F001

Mechanical operation counter - MOC

Size	Type	Code
E1.2	MOC Mechanical operation counter	1SDA073780R1
E2.2...E6.2	MOC Mechanical operation counter	1SDA073781R1

Key lock in open position - KLC

Size	Type	Code
E1.2	KLC-D Key lock open E1.2	1SDA073782R1
E1.2	KLC-S Key lock open N.20005 E1.2	1SDA073783R1
E1.2	KLC-S Key lock open N.20006 E1.2	1SDA073784R1
E1.2	KLC-S Key lock open N.20007 E1.2	1SDA073785R1
E1.2	KLC-S Key lock open N.20008 E1.2	1SDA073786R1
E1.2	KLC-S Key lock open N.20009 E1.2	1SDA073787R1
E1.2	KLA Castell key lock open E1.2*	1SDA073788R1
E1.2	KLA Kirk key lock open E1.2	1SDA073789R1
E1.2	KLA Ronis Profalux key lock open E1.2	1SDA073790R1
E2.2...E6.2	KLC-D Key lock open E2.2...E6.2	1SDA073791R1
E2.2...E6.2	KLC-S key lock open N.20005 E2.2..E6.2	1SDA073792R1
E2.2...E6.2	KLC-S key lock open N.20006 E2.2..E6.2	1SDA073793R1
E2.2...E6.2	KLC-S key lock open N.20007 E2.2..E6.2	1SDA073794R1
E2.2...E6.2	KLC-S key lock open N.20008 E2.2..E6.2	1SDA073795R1
E2.2...E6.2	KLC-S key lock open N.20009 E2.2..E6.2	1SDA073796R1
E2.2...E6.2	KLC-A Castell key lock open E2.2..E6.2*	1SDA073797R1
E2.2...E6.2	KLC-A Kirk key lock open E2.2..E6.2	1SDA073798R1
E2.2...E6.2	KLC-A Ronis Profalux key lock open E2.2..E6.2	1SDA073799R1

* only mounted. For loose supply contact ABB SACE.

Padlocks in open position - PLC

Size	Type	Code
E1.2	PLC E1.2 Padlocks in open position D=4mm	1SDA073800R1
E1.2	PLC E1.2 Padlocks in open position D=7mm	1SDA073801R1
E1.2	PLC E1.2 Padlocks in open position D=8mm	1SDA073802R1
E2.2...E6.2	PLC E2.2..E6.2 Padlocks in open position D=4mm	1SDA073803R1
E2.2...E6.2	PLC E2.2..E6.2 Padlocks in open position D=7mm	1SDA073804R1
E2.2...E6.2	PLC E2.2..E6.2 Padlocks in open position D=8mm	1SDA073805R1

Floor fixing plate - F

Size	Type	Code
E1.2	Floor fixing plate for fixed unit	1SDA076020R1

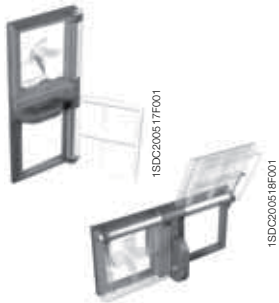

1SDC200517F001

1SDC200518F001

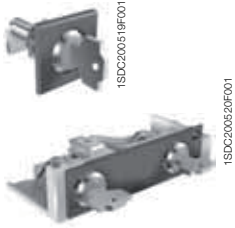

Key lock in racked-in / test / racked-out position- KLP

Size	Type	Code
E1.2	KLP-D Bl. Racked in/out E1.2 1st key	1SDA073822R1
E1.2	KLP-S Bl. Racked in/out N.20005 E1.2 1st key	1SDA073823R1
E1.2	KLP-S Bl. Racked in/out N.20006 E1.2 1st key	1SDA073824R1
E1.2	KLP-S Bl. Racked in/out N.20007 E1.2 1st key	1SDA073825R1
E1.2	KLP-S Bl. Racked in/out N.20008 E1.2 1st key	1SDA073826R1
E1.2	KLP-S Bl. Racked in/out N.20009 E1.2 1st key	1SDA073827R1
E1.2	KLP-D Bl. Racked in/out E1.2 2nd key	1SDA073828R1
E1.2	KLP-S Bl. Racked in/out N.20005 E1.2 2nd key	1SDA073829R1
E1.2	KLP-S Bl. Racked in/out N.20006 E1.2 2nd key	1SDA073830R1
E1.2	KLP-S Bl. Racked in/out N.20007 E1.2 2nd key	1SDA073831R1
E1.2	KLP-S Bl. Racked in/out N.20008 E1.2 2nd key	1SDA073832R1
E1.2	KLP-S Bl. Racked in/out N.20009 E1.2 2nd key	1SDA073833R1
E1.2	KLP-A Bl. Racked in/out RonProf Kirk E1.2 1st key	1SDA073834R1
E1.2	KLP-A Bl. Racked in/out RonProf Kirk E1.2 2nd key	1SDA073835R1
E1.2	KLP-A Bl. Racked in/out Castell E1.2 1st key*	1SDA073836R1
E1.2	KLP-A Bl. Racked in/out Castell E1.2 2nd key*	1SDA073837R1
E2.2...E6.2	KLP-D Bl. Racked in/out E2.2...E6.2 1st key	1SDA073806R1
E2.2...E6.2	KLP-S Bl. Racked in/out N.20005 E2.2...E6.2 1st key	1SDA073807R1
E2.2...E6.2	KLP-S Bl. Racked in/out N.20006 E2.2...E6.2 1st key	1SDA073808R1
E2.2...E6.2	KLP-S Bl. Racked in/out N.20007 E2.2...E6.2 1st key	1SDA073809R1
E2.2...E6.2	KLP-S Bl. Racked in/out N.20008 E2.2...E6.2 1st key	1SDA073810R1
E2.2...E6.2	KLP-S Bl. Racked in/out N.20009 E2.2...E6.2 1st key	1SDA073811R1
E2.2...E6.2	KLP-D Bl. Racked in/out E2.2...E6.2 2nd key	1SDA073812R1
E2.2...E6.2	KLP-S Bl. Racked in/out N.20005 E2.2...E6.2 2nd key	1SDA073813R1
E2.2...E6.2	KLP-S Bl. Racked in/out N.20006 E2.2...E6.2 2nd key	1SDA073814R1
E2.2...E6.2	KLP-S Bl. Racked in/out N.20007 E2.2...E6.2 2nd key	1SDA073815R1
E2.2...E6.2	KLP-S Bl. Racked in/out N.20008 E2.2...E6.2 2nd key	1SDA073816R1
E2.2...E6.2	KLP-S Bl. Racked in/out N.20009 E2.2...E6.2 2nd key	1SDA073817R1
E2.2...E6.2	KLP-A Bl. Racked in/out RoProKirk E2.2...E6.2 1st key	1SDA073818R1
E2.2...E6.2	KLP-A Bl. Racked in/out RoProKirk E2.2...E6.2 2nd key	1SDA073819R1
E2.2...E6.2	KLP-A Bl. Racked in/out Castell E2.2...E6.2 1st key*	1SDA073820R1
E2.2...E6.2	KLP-A Bl. Racked in/out Castell E2.2...E6.2 2nd key*	1SDA073821R1

When the PLP is already present, you have to order the KLP 2nd key and not the KLP 1st key
 * only mounted. For loose supply contact ABB SACE.

Accessory for supplementary lock in racked-out position

Size	Type	Code
E1.2	Suppl. locks in racked-out E1.2	1SDA073838R1
E2.2...E6.2	Suppl. locks in racked-out E2.2...E6.2	1SDA073839R1

Padlock in racked-in / test / racked-out position - PLP

Size	Type	Code
E1.2	PLP Bl. padlocks Racked in/out D=4/6/8mm E1.2	1SDA073840R1
E2.2...E6.2	PLP Bl. padlocks Racked in/out D=4/6/8mm E2.2...E6.2	1SDA073841R1

External shutter lock- SLE

Size	Type	Code
E2.2	SLE Bl. shutter lock D=4/6/8mm E2.2	1SDA073842R1
E4.2	SLE Bl. shutter lock D=4/6/8mm E4.2	1SDA073843R1
E6.2	SLE Bl. shutter lock D=4/6/8mm E6.2	1SDA073844R1



Accessories

Mechanical accessories



1SDC200689F001

Lock for racking in / racking out the mobile part when the door is open - DLR

Size	Type	Code
E2.2...E6.2	DLR E2.2...E6.2*	1SDA073845R1

*Only as loose part



1SDC200592F001

Lock to prevent door opening when circuit-breaker is in racked-in / test position - DLP

Size	Type	Code
E2.2...E6.2	DLP E2.2...E6.2*	1SDA073849R1

*Only as loose part

Lock to prevent door opening when circuit-breaker is in closed position - DLC

Size	Type	Code
E1.2	DLC Interlock cable door E1.2	1SDA073850R1
E1.2	DLC Interlock direct door E1.2	1SDA073851R1
E2.2...E6.2	DLC Interlock cable door E2.2...E6.2*	1SDA073852R1
E2.2...E6.2	DLC Interlock direct door E2.2...E6.2*	1SDA073853R1

* To be ordered with lever for interlock [group 2] and support for interlock [1SDA073895R1]



1SDC200595F001

Protection device for opening and closing pushbuttons - PBC

Size	Type	Code
E1.2	PBC Prot. Pushbuttons AP/CH E1.2	1SDA073854R1
E1.2	PBC Prot. Pushbuttons AP/CH D=4mm E1.2	1SDA073855R1
E1.2	PBC Prot. Pushbuttons AP/CH D=7mm E1.2	1SDA073856R1
E1.2	PBC Prot. Pushbuttons AP/CH D=8mm E1.2	1SDA073857R1
E2.2...E6.2	PBC Prot. Pushbuttons AP/CH E2.2...E6.2	1SDA073858R1
E2.2...E6.2	PBC Prot. Pushbuttons AP/CH D=4mm E2.2...E6.2	1SDA073859R1
E2.2...E6.2	PBC Prot. Pushbuttons AP/CH D=7mm E2.2...E6.2	1SDA073860R1
E2.2...E6.2	PBC Prot. Pushbuttons AP/CH D=8mm E2.2...E6.2	1SDA073861R1

9



1SDC200527F001

1SDC200528F001

Circuit-breaker flange

Size	Type	Code
E1.2	IP30 Flange E1.2 F	1SDA073862R1
E1.2	IP30 Flange E1.2 W	1SDA073863R1
E2.2...E6.2	IP30 Flange E2.2...E6.2 F	1SDA073864R1
E2.2...E6.2	IP30 Flange E2.2...E6.2 W	1SDA073865R1
E1.2	IP54 Flange different keys E1.2*	1SDA073866R1
E2.2...E6.2	IP54 Flange different keys E2.2...E6.2*	1SDA073867R1
E1.2	IP54 Flange key No. 20005 E1.2*	1SDA073868R1
E2.2...E6.2	IP54 Flange key No. 20005 E2.2...E6.2*	1SDA073869R1
E2.2...E6.2	Sealable trip unit cover	1SDA073870R1

*Only as loose part



1SDC200529F001

High or low terminal covers- HTC/LTC

Size	Type	3 poles	4 poles
		Code	Code
E1.2	HTC high terminal covers E1.2 2pcs	1SDA073871R1	1SDA073872R1
E1.2	LTC low terminal covers E1.2 F 2pcs	1SDA073873R1	1SDA073874R1



1SDC200530F001

Separators - PB

Size	Type	Code
E1.2	PB Separators H=100mm 4pz E1.2 F 3P	1SDA073877R1
E1.2	PB Separators H=100mm 6pz E1.2 F 4P	1SDA073878R1
E1.2	PB Separators H=200mm 4pz E1.2 F 3P	1SDA073879R1
E1.2	PB Separators H=200mm 6pz E1.2 F 4P	1SDA073880R1
E1.2	PB Separators 2 pz E1.2 W FP 3P	1SDA076164R1
E1.2	PB Separators 3 pz E1.2 W FP 4P	1SDA076165R1
E2.2...E6.2	PB Separators 2 pz E2.2...E6.2 F 3P	1SDA076166R1
E2.2...E6.2	PB Separators 3 pz E2.2...E6.2 F 4P	1SDA076167R1
E2.2...E6.2	PB Separators 2 pz E2.2...E6.2 W FP 3P	1SDA076168R1
E2.2...E6.2	PB Separators 3 pz E2.2...E6.2 W FP 4P	1SDA076169R1

Accessories

Mechanical interlock

Cables for mechanical interlock [Group 1]

Size	Type	Code
E1.2..E6.2	Type A horizontal	1SDA073881R1
E2.2..E6.2	Type B,C,D horizontal	1SDA073882R1
E1.2..E6.2	Type A vertical	1SDA073885R1
E2.2..E6.2	Type B,C,D vertical	1SDA073886R1

Order one type of cable for each interlock. The cable must be ordered on the fixed circuit-breaker or on the fixed part of withdrawable circuit-breaker.

Lever for mechanical interlock of fixed circuit-breaker or mobile part [Group 2]

Size	Type	3 Poles	4 Poles
		Code	Code
E2.2	Lever for mechanical interlock	1SDA073889R1	1SDA073889R1
E4.2	Lever for mechanical interlock	1SDA073890R1	1SDA073890R1
E6.2	Lever for mechanical interlock	1SDA073891R1	1SDA073892R1

The lever for mechanical interlock is not required for E1.2

Support for mechanical interlock of fixed circuit-breaker [Group 3]

Size	Type	Code
E1.2	Type A	1SDA073893R1
E1.2	Type A - Installed on bottom plate	1SDA073894R1
E2.2 ... E6.2	Type A / B / D	1SDA073895R1
E2.2 ... E6.2	Type C	1SDA073897R1

Support for mechanical interlock of fixed part [Group 4]

Size	Type	Code
E1.2	Type A	1SDA073896R1
E2.2 ... E6.2	Type A / B / D	1SDA073895R1
E2.2 ... E6.2	Type C	1SDA073897R1

Automatic transfer switch

Size	Type	Code
E1.2..E6.2	ATS021	1SDA065523R1
E1.2..E6.2	ATS022	1SDA065524R1



1SDC200337F001



1SDC200338F001

Accessories

Ekip modules



1SDC200446F001



1SDC200466F001



1SDC200480F001



1SDC200475F001



1SDC200476F001

Ekip electrical trip units - loose supply

Size	Type	Code
E1.2..E6.2	Ekip Dip LI	1SDA074194R1
E1.2..E6.2	Ekip Dip LSI	1SDA074195R1
E1.2..E6.2	Ekip Dip LSIG	1SDA074196R1
E1.2..E6.2	Ekip Touch LI*	1SDA074197R1
E1.2..E6.2	Ekip Touch LSI*	1SDA074198R1
E1.2..E6.2	Ekip Touch LSIG*	1SDA074199R1
E1.2..E6.2	Ekip G Touch LSIG*	1SDA074200R1
E1.2..E6.2	Ekip Hi-Touch LSI*	1SDA074201R1
E1.2..E6.2	Ekip Hi-Touch LSIG*	1SDA074202R1
E1.2..E6.2	Ekip G Hi-Touch LSIG*	1SDA074203R1
E1.2..E6.2	Ekip LCD LI*	1SDA074204R1
E1.2..E6.2	Ekip LCD LSI*	1SDA074205R1
E1.2..E6.2	Ekip LCD LSIG*	1SDA074206R1
E1.2..E6.2	Ekip G LCD LSIG*	1SDA074207R1
E1.2..E6.2	Ekip Hi-LCD LSI*	1SDA074208R1
E1.2..E6.2	Ekip Hi-LCD LSIG*	1SDA074209R1
E1.2..E6.2	Ekip G Hi-LCD LSIG*	1SDA074210R1
E1.2..E6.2	Battery for Ekip trip units*	1SDA074193R1

* Ekip TT standard supply

Options for Ekip electrical trip units

Size	Type	Code
E1.2..E6.2	Ekip LCD Installed	1SDA074211R1
E1.2..E6.2	Ekip Power Controller	1SDA074212R1
E1.2..E6.2	Upper internal installed voltage outlets	1SDA074216R1
E1.2..E6.2	External installed voltage outlets	1SDA074217R1
E1.2..E6.2	Arrangement for cables with lower internal voltage outlets	1SDA074213R1
E1.2..E6.2	Arrangement for cables with upper internal voltage outlets	1SDA074214R1
E1.2..E6.2	Arrangement for cables with external voltage outlets	1SDA074215R1

Power Supply modules

Size	Type	Code
E1.2..E6.2	Ekip Supply 110-240V AC/DC	1SDA074172R1
E1.2..E6.2	Ekip Supply 24-48V DC	1SDA074173R1

Connectivity modules

Size	Type	Code
E1.2..E6.2	Ekip Com Modbus RS-485	1SDA074150R1
E1.2..E6.2	Ekip Com Modbus TCP	1SDA074151R1
E1.2..E6.2	Ekip Com Profibus	1SDA074152R1
E1.2..E6.2	Ekip Com Profinet	1SDA074153R1
E1.2..E6.2	Ekip Com DeviceNet	1SDA074154R1
E1.2..E6.2	Ekip Com EtherNet/IP	1SDA074155R1
E1.2..E6.2	Ekip Com IEC61850	1SDA074156R1
E1.2..E6.2	Ekip Com R Modbus RS-485	1SDA074157R1
E1.2..E6.2	Ekip Com R Modbus TCP	1SDA074158R1
E1.2..E6.2	Ekip Com R Profibus	1SDA074159R1
E1.2..E6.2	Ekip Com R Profinet	1SDA074160R1
E1.2..E6.2	Ekip Com R DeviceNet	1SDA074161R1
E1.2..E6.2	Ekip Com R EtherNet/IP	1SDA074162R1
E1.2..E6.2	Ekip Link	1SDA074163R1
E1.2..E6.2	Ekip Bluetooth	1SDA074164R1
E1.2..E6.2	Ekip Com GPRS-M	1SDA074165R1
E1.2..E6.2	Ekip Com Actuator	1SDA074166R1



1SDC200539F001



1SDC200540F001



1SDC200541F001



1SDC200644F001



1SDC200648F001



1SDC200688F001



1SDC200658F001



1SDC200659F001

Signalling modules

Size	Type	Code
E1.2..E6.2	Ekip Signalling 2K-1	1SDA074167R1
E1.2..E6.2	Ekip Signalling 2K-2	1SDA074168R1
E1.2..E6.2	Ekip Signalling 2K-3	1SDA074169R1
E2.2..E6.2	Ekip Signalling 4K	1SDA074170R1
E1.2..E6.2	Ekip Signalling 10K*	1SDA074171R1

*Only as loose part

Measuring and Measuring Pro modules

Size	Type	Code
E1.2	Ekip Measuring	1SDA074184R1
E1.2	Ekip Measuring Pro	1SDA074185R1
E2.2	Ekip Measuring	1SDA074186R1
E2.2	Ekip Measuring Pro	1SDA074187R1
E4.2	Ekip Measuring	1SDA074188R1
E4.2	Ekip Measuring Pro	1SDA074189R1
E6.2	Ekip Measuring	1SDA074190R1
E6.2	Ekip Measuring Pro	1SDA074191R1
E1.2	Voltage socket for neutral on right side L1 L2 L3 N - E1.2 *	1SDA076244R1
E2.2	Voltage socket for neutral on right side L1 L2 L3 N - E2.2 *	1SDA076245R1
E4.2	Voltage socket for neutral on right side L1 L2 L3 N - E4.2 *	1SDA076246R1
E6.2	Voltage socket for neutral on right side L1 L2 L3 N - E6.2 *	1SDA076247R1

*use only with circuit breakers with neutral on right side L1 L2 L3 N

Synchrocheck modules

Size	Type	Code
E1.2..E6.2	Ekip Synchrocheck	1SDA074183R1

Displaying and supervision systems

Size	Type	Code
E1.2..E6.2	Ekip T&P - Programming and Test unit	1SDA066989R1
E1.2..E6.2	Ekip TT - Trip Test unit	1SDA066988R1
E1.2..E6.2	Ekip Programming	1SDA076154R1
E1.2..E6.2	Ekip Multimeter Display on front of switchgear*	1SDA074192R1
E1.2..E6.2	Ekip Control Panel for 10 circuit-breakers	1SDA074311R1
E1.2..E6.2	Ekip control panel for 30 circuit-breakers	1SDA074312R1
E1.2..E6.2	Ekip Control Panel license extension to 30 circuit-breakers	1SDA074313R1
E1.2..E6.2	Ekip Control Panel alarm dispatcher option	1SDA074314R1
E1.2..E6.2	Ekip Control Panel option 5 access web client	1SDA074315R1
E1.2..E6.2	Ekip View Software for 30 circuit-breakers	1SDA074298R1
E1.2..E6.2	Ekip View software for 60 circuit-breakers	1SDA074299R1
E1.2..E6.2	Ekip View software for unlimited circuit-breakers	1SDA074300R1
E1.2..E6.2	Ekip View license extension to 60 circuit-breakers	1SDA074301R1
E1.2..E6.2	Ekip View license extension for an unlimited number of circuit-breakers	1SDA074302R1
E1.2..E6.2	Ekip View alarm dispatcher option for 30 circuit-breakers	1SDA074303R1
E1.2..E6.2	Ekip View alarm dispatcher option for 60 circuit-breakers	1SDA074304R1
E1.2..E6.2	Ekip View alarm dispatcher option for an unlimited number of circuit-breakers	1SDA074305R1
E1.2..E6.2	Ekip View 5 web access client option license of 30 circuit-breakers	1SDA074306R1
E1.2..E6.2	Ekip View 5 web access client option license of 60 circuit-breakers	1SDA074307R1
E1.2..E6.2	Ekip View 5 web access client option license for an unlimited number of circuit-breakers	1SDA074308R1

*Only as loose part

Accessories

Ekip modules



Rating plug for Ekip trip units

Size	Type	Code (loose supply)	Code (installed)
E1.2..E2.2	Rating Plug 100A	1SDA074218R1	1SDA074258R1
E1.2..E2.2	Rating Plug 200A	1SDA074219R1	1SDA074259R1
E1.2..E2.2	Rating Plug 250A	1SDA074220R1	1SDA074260R1
E1.2..E6.2	Rating Plug 400A	1SDA074221R1	1SDA074261R1
E1.2..E6.2	Rating Plug 630A	1SDA074222R1	1SDA074262R1
E1.2..E6.2	Rating Plug 800A	1SDA074223R1	1SDA074263R1
E1.2..E6.2	Rating Plug 1000A	1SDA074224R1	1SDA074264R1
E1.2..E6.2	Rating Plug 1250A	1SDA074225R1	1SDA074265R1
E1.2..E6.2	Rating Plug 1600A	1SDA074226R1	1SDA074266R1
E2.2..E6.2	Rating Plug 2000A	1SDA074227R1	1SDA074267R1
E2.2..E6.2	Rating Plug 2500A	1SDA074228R1	1SDA074268R1
E4.2..E6.2	Rating Plug 3200A	1SDA074229R1	1SDA074269R1
E4.2..E6.2	Rating Plug 4000A	1SDA074230R1	1SDA074270R1
E6.2	Rating Plug 5000A	1SDA074231R1	1SDA074271R1
E6.2	Rating Plug 6300A	1SDA074232R1	-
E1.2..E2.2	Rating Plug 100A L OFF	1SDA074233R1	1SDA074273R1
E1.2..E2.2	Rating Plug 200A L OFF	1SDA074234R1	1SDA074274R1
E1.2..E2.2	Rating Plug 250A L OFF	1SDA074235R1	1SDA074275R1
E1.2..E6.2	Rating Plug 400A L OFF	1SDA074236R1	1SDA074276R1
E1.2..E6.2	Rating Plug 630A L OFF	1SDA074237R1	1SDA074277R1
E1.2..E6.2	Rating Plug 800A L OFF	1SDA074238R1	1SDA074278R1
E1.2..E6.2	Rating Plug 1000A L OFF	1SDA074239R1	1SDA074279R1
E1.2..E6.2	Rating Plug 1250A L OFF	1SDA074240R1	1SDA074280R1
E1.2..E6.2	Rating Plug 1600A L OFF	1SDA074241R1	1SDA074281R1
E2.2..E6.2	Rating Plug 2000A L OFF	1SDA074242R1	1SDA074282R1
E2.2..E6.2	Rating Plug 2500A L OFF	1SDA074243R1	1SDA074283R1
E4.2..E6.2	Rating Plug 3200A L OFF	1SDA074244R1	1SDA074284R1
E4.2..E6.2	Rating Plug 4000A L OFF	1SDA074245R1	1SDA074285R1
E6.2	Rating Plug 5000A L OFF	1SDA074246R1	1SDA074286R1
E6.2	Rating Plug 6300A L OFF	1SDA074247R1	1SDA074287R1
E1.2..E2.2	Rating Plug RC 100A	1SDA074248R1	1SDA074288R1
E1.2..E2.2	Rating Plug RC 200A	1SDA074249R1	1SDA074289R1
E1.2..E2.2	Rating Plug RC 250A	1SDA074250R1	1SDA074290R1
E1.2..E6.2	Rating Plug RC 400A	1SDA074251R1	1SDA074291R1
E1.2..E6.2	Rating Plug RC 630A	1SDA074252R1	1SDA074292R1
E1.2..E6.2	Rating Plug RC 800A	1SDA074253R1	1SDA074293R1
E1.2..E6.2	Rating Plug RC 1250A	1SDA074254R1	1SDA074294R1
E2.2..E6.2	Rating Plug RC 2000A	1SDA074255R1	1SDA074295R1
E4.2..E6.2	Rating Plug RC 3200A	1SDA074256R1	1SDA074296R1
E4.2..E6.2	Rating Plug RC 4000A	1SDA074257R1	1SDA074297R1

Accessories

Terminals

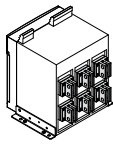

Rear orientable terminal - HR VR

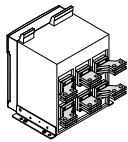

Horizontal rear spread terminal - SHR

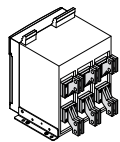

Vertical rear spread terminal - SVR

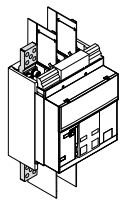

Extended front terminal - EF

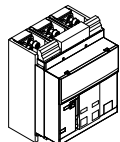

Front terminal - F

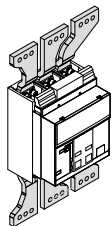

Front spread terminal - ES

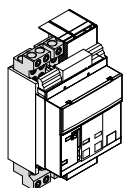

Terminal for cable FcCuAl
4x240mm² - Fc CuAl

Kit for terminals - installed for fixed circuit-breaker

Size	Version	lu max	Type	3 Poles	4 Poles
				Code	Code
E1.2	F	1600	Kit EF Upper	1SDA073963R1	1SDA073964R1
E1.2	F	1600	Kit EF Lower	1SDA073965R1	1SDA073966R1
E1.2	F	1600	Kit ES Upper	1SDA073975R1	1SDA073976R1
E1.2	F	1600	Kit ES Lower	1SDA073977R1	1SDA073978R1
E1.2	F	1600	Kit HR Upper	1SDA073981R1	1SDA073982R1
E1.2	F	1600	Kit HR Lower	1SDA073983R1	1SDA073984R1
E1.2	F	1600	Kit VR Upper	1SDA073985R1	1SDA073986R1
E1.2	F	1600	Kit VR Lower	1SDA073987R1	1SDA073988R1
E1.2	F	1600	Kit FC CuAl 4x240 mm ² Upper	1SDA073997R1	1SDA073998R1
E1.2	F	1600	Kit FC CuAl 4x240 mm ² Lower	1SDA073999R1	1SDA074000R1
E2.2	F	2000	Kit VR Upper	1SDA074003R1	1SDA074004R1
E2.2	F	2000	Kit VR Lower	1SDA074005R1	1SDA074006R1
E2.2	F	2500	Kit VR Upper	1SDA074009R1	1SDA074010R1
E2.2	F	2500	Kit VR Lower	1SDA074011R1	1SDA074012R1
E2.2	F	2000	Kit SHR Upper	1SDA074045R1	1SDA074046R1
E2.2	F	2000	Kit SHR Lower	1SDA074047R1	1SDA074048R1
E2.2	F	2500	Kit SHR Upper	1SDA074051R1	1SDA074052R1
E2.2	F	2500	Kit SHR Lower	1SDA074053R1	1SDA074054R1
E2.2	F	2000	Kit SVR Upper	1SDA074057R1	1SDA074058R1
E2.2	F	2000	Kit SVR Lower	1SDA074059R1	1SDA074060R1
E2.2	F	2500	Kit SVR Upper	1SDA074063R1	1SDA074064R1
E2.2	F	2500	Kit SVR Lower	1SDA074065R1	1SDA074066R1
E2.2	F	2500	Kit F Upper	1SDA074118R1	1SDA074119R1
E2.2	F	2500	Kit F Lower	1SDA074120R1	1SDA074121R1
E4.2	F	3200	Kit VR Upper	1SDA074015R1	1SDA074016R1
E4.2	F	3200	Kit VR Lower	1SDA074017R1	1SDA074018R1
E4.2	F	4000	Kit HR Upper	1SDA076878R1	1SDA076879R1
E4.2	F	4000	Kit HR Lower	1SDA076880R1	1SDA076881R1
E4.2	F	4000	Kit VR Upper	1SDA074021R1	1SDA074022R1
E4.2	F	4000	Kit VR Lower	1SDA074023R1	1SDA074024R1
E4.2	F	4000	Kit F Upper	1SDA074126R1	1SDA074127R1
E4.2	F	4000	Kit F Lower	1SDA074128R1	1SDA074129R1
E6.2	F	5000	Kit VR Upper	1SDA074027R1	1SDA074028R1
E6.2	F	5000	Kit VR Lower	1SDA074030R1	1SDA074031R1
E6.2/f	F	5000	Kit VR Upper		1SDA074029R1
E6.2/f	F	5000	Kit VR Lower		1SDA074032R1
E6.2	F	6300	Kit F Upper	1SDA074134R1	1SDA074135R1
E6.2	F	6300	Kit F Lower	1SDA074137R1	1SDA074138R1
E6.2/f	F	6300	Kit F Upper		1SDA074136R1
E6.2/f	F	6300	Kit F Lower		1SDA074139R1
E6.2	F	6300	Kit VR Upper	1SDA074036R1	1SDA074037R1
E6.2	F	6300	Kit VR Lower	1SDA074039R1	1SDA074040R1
E6.2/f	F	6300	Kit VR Upper		1SDA074038R1
E6.2/f	F	6300	Kit VR Lower		1SDA074041R1

Accessories Terminals

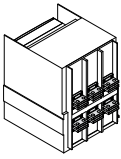

Rear adjustable terminal - HR VR

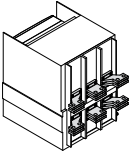

Horizontal rear terminal - SHR

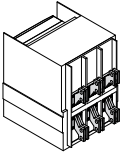

Vertical rear spread terminal - SVR

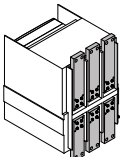

Front terminal - F

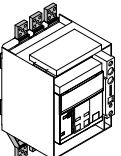

Extended front terminal - EF

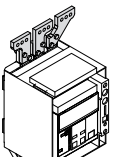

Front spread terminal - ES

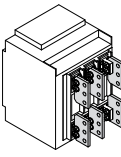

Terminal for cable FcCuAl
4x240mm² - Fc CuAl

Kit for terminals - installed for fixed part of withdrawable circuit-breaker

Size	Version	lu max	Type	3 Poles		4 Poles	
				Code	Code	Code	Code
E1.2	W	1600	Kit EF Upper	1SDA073939R1		1SDA073940R1	
E1.2	W	1600	Kit EF Lower	1SDA073941R1		1SDA073942R1	
E1.2	W	1600	Kit VR Upper	1SDA073945R1		1SDA073946R1	
E1.2	W	1600	Kit VR Lower	1SDA073947R1		1SDA073948R1	
E1.2	W	1600	Kit ES Upper *	1SDA073951R1		1SDA073952R1	
E1.2	W	1600	Kit ES Lower *	1SDA073953R1		1SDA073954R1	
E1.2	W	1600	Kit SHR Upper	1SDA073957R1		1SDA073958R1	
E1.2	W	1600	Kit SHR Lower	1SDA073959R1		1SDA073960R1	
E1.2	W	1600	Kit FC CuAl Upper	1SDA073991R1		1SDA073993R1	
E1.2	W	1600	Kit FC CuAl Lower	1SDA073992R1		1SDA073994R1	
E2.2	W	2000	Kit VR Upper	1SDA074577R1		1SDA074578R1	
E2.2	W	2000	Kit VR Lower	1SDA074579R1		1SDA074580R1	
E2.2	W	2500	Kit VR Upper	1SDA074581R1		1SDA074582R1	
E2.2	W	2500	Kit VR Lower	1SDA074583R1		1SDA074584R1	
E2.2	W	2000	Kit SHR Upper	1SDA074585R1		1SDA074586R1	
E2.2	W	2000	Kit SHR Lower	1SDA074587R1		1SDA074588R1	
E2.2	W	2500	Kit SHR Upper	1SDA074589R1		1SDA074590R1	
E2.2	W	2500	Kit SHR Lower	1SDA074591R1		1SDA074592R1	
E2.2	W	2000	Kit SVR Upper	1SDA074593R1		1SDA074594R1	
E2.2	W	2000	Kit SVR Lower	1SDA074595R1		1SDA074596R1	
E2.2	W	2500	Kit SVR Upper	1SDA074597R1		1SDA074598R1	
E2.2	W	2500	Kit SVR Lower	1SDA074599R1		1SDA074600R1	
E2.2	W	2500	Kit FL Upper	1SDA074069R1		1SDA074070R1	
E2.2	W	2500	Kit FL Lower	1SDA074071R1		1SDA074072R1	
E2.2	W	2500	Kit F Upper	1SDA074090R1		1SDA074091R1	
E2.2	W	2500	Kit F Lower	1SDA074092R1		1SDA074093R1	
E4.2	W	3200	Kit VR Upper	1SDA074601R1		1SDA074602R1	
E4.2	W	3200	Kit VR Lower	1SDA074603R1		1SDA074604R1	
E4.2	W	4000	Kit VR Upper	1SDA074605R1		1SDA074606R1	
E4.2	W	4000	Kit VR Lower	1SDA074607R1		1SDA074608R1	
E4.2	W	4000	Kit F Upper	1SDA074098R1		1SDA074099R1	
E4.2	W	4000	Kit F Lower	1SDA074100R1		1SDA074101R1	
E4.2	W	4000	Kit FL Upper	1SDA074075R1		1SDA074076R1	
E4.2	W	4000	Kit FL Lower	1SDA074077R1		1SDA074078R1	
E6.2	W	5000	Kit VR Upper	1SDA074609R1		1SDA074610R1	
E6.2	W	5000	Kit VR Lower	1SDA074612R1		1SDA074613R1	
E6.2/f	W	5000	Kit VR Upper			1SDA074611R1	
E6.2/f	W	5000	Kit VR Lower			1SDA074614R1	
E6.2	W	6300	Kit VR Upper	1SDA074615R1		1SDA074616R1	
E6.2	W	6300	Kit VR Lower	1SDA074618R1		1SDA074619R1	
E6.2/f	W	6300	Kit VR Upper			1SDA074617R1	
E6.2/f	W	6300	Kit VR Lower			1SDA074620R1	
E6.2	W	6300	Kit F Upper	1SDA074106R1		1SDA074107R1	
E6.2	W	6300	Kit F Lower	1SDA074109R1		1SDA074110R1	
E6.2/f	W	6300	Kit F Upper			1SDA074108R1	
E6.2/f	W	6300	Kit F Lower			1SDA074111R1	
E6.2	W	6300	Kit FL Upper	1SDA074081R1		1SDA074082R1	
E6.2	W	6300	Kit FL Lower	1SDA074084R1		1SDA074085R1	
E6.2/f	W	6300	Kit FL Upper			1SDA074083R1	
E6.2/f	W	6300	Kit FL Lower			1SDA074086R1	

* can be ordered only if the fixed part has EF terminals.

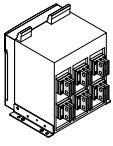

Rear adjustable terminal - HR VR

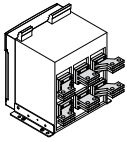

Horizontal rear spread terminal - SHR

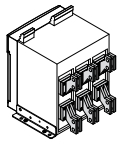

Vertical rear spread terminal - SVR

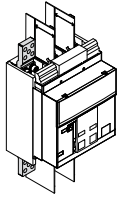

Extended front terminal - EF

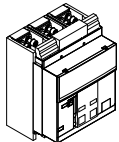

Front terminal - F

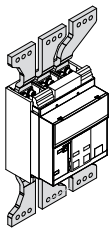

Front spread terminal - ES

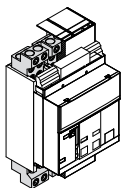

Terminal for cable FcCuAl
4x240mm² - Fc CuAl

Kit for terminals - loose supply for fixed circuit-breaker

Size	Version	Iu max	Type	3 Poles	4 Poles
				Code	Code
E1.2	F	1600	Kit EF	1SDA073967R1	1SDA073968R1
E1.2	F	1600	Kit F	1SDA073973R1	1SDA073974R1
E1.2	F	1600	Kit ES	1SDA073979R1	1SDA073980R1
E1.2	F	1600	Kit Adjustable HR/VR	1SDA073989R1	1SDA073990R1
E1.2	F	1600	Kit FC CuAl 4x240 mm ²	1SDA074001R1	1SDA074002R1
E2.2	F	2000	Kit Adjustable HR/VR	1SDA074007R1	1SDA074008R1
E2.2	F	2500	Kit Adjustable HR/VR	1SDA074013R1	1SDA074014R1
E2.2	F	2000	Kit SHR	1SDA074049R1	1SDA074050R1
E2.2	F	2500	Kit SHR	1SDA074055R1	1SDA074056R1
E2.2	F	2000	Kit SVR	1SDA074061R1	1SDA074062R1
E2.2	F	2500	Kit SVR	1SDA074067R1	1SDA074068R1
E2.2	F	2500	Kit F Upper	1SDA074122R1	1SDA074123R1
E2.2	F	2500	Kit F Lower	1SDA074124R1	1SDA074125R1
E4.2	F	3200	Kit Adjustable HR/VR	1SDA074019R1	1SDA074020R1
E4.2	F	4000	Kit Adjustable HR/VR	1SDA074025R1	1SDA074026R1
E4.2	F	4000	Kit F Upper	1SDA074130R1	1SDA074131R1
E4.2	F	4000	Kit F Lower	1SDA074132R1	1SDA074133R1
E6.2	F	5000	Kit Adjustable HR/VR	1SDA074033R1	1SDA074034R1
E6.2/f	F	5000	Kit Adjustable HR/VR		1SDA074035R1
E6.2	F	6300	Kit Adjustable HR/VR	1SDA074042R1	1SDA074043R1
E6.2/f	F	6300	Kit Adjustable HR/VR		1SDA074044R1
E6.2	F	6300	Kit F Upper	1SDA074140R1	1SDA074141R1
E6.2	F	6300	Kit F Lower	1SDA074143R1	1SDA074144R1
E6.2/f	F	6300	Kit F Upper		1SDA074142R1
E6.2/f	F	6300	Kit F Lower		1SDA074145R1

Accessories Terminals

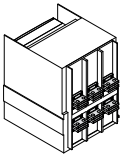

Rear orientable terminal - HR VR

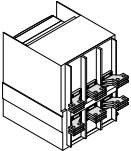

Horizontal rear terminal - SHR

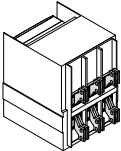

Vertical rear spread terminal - SVR

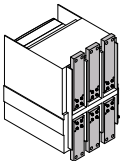

Front terminal - F

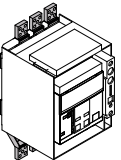

Extended front terminal - EF

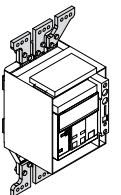

Front spread terminal - ES

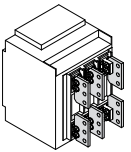

Terminal for cable FcCuAl
4x240mm² - Fc CuAl

Kit for terminals - loose supply for fixed part of withdrawable circuit-breaker

Size	Version	lu max	Type	3 Poles		4 Poles	
				Code		Code	
E1.2	W	1600	Kit EF	1SDA073943R1		1SDA073944R1	
E1.2	W	1600	Kit Adjustable HR/VR	1SDA073949R1		1SDA073950R1	
E1.2	W	1600	Kit ES	1SDA073955R1		1SDA073956R1	
E1.2	W	1600	Kit SHR	1SDA073961R1		1SDA073962R1	
E1.2	W	1600	Kit FC CuAl	1SDA073995R1		1SDA073996R1	
E2.2	W	2000	Kit Adjustable HR/VR	1SDA074007R1		1SDA074008R1	
E2.2	W	2500	Kit Adjustable HR/VR	1SDA074013R1		1SDA074014R1	
E2.2	W	2000	Kit SHR	1SDA074049R1		1SDA074050R1	
E2.2	W	2500	Kit SHR	1SDA074055R1		1SDA074056R1	
E2.2	W	2000	Kit SVR	1SDA074061R1		1SDA074062R1	
E2.2	W	2500	Kit SVR	1SDA074067R1		1SDA074068R1	
E2.2	W	2500	Kit FL	1SDA074073R1		1SDA074074R1	
E2.2	F	2500	Kit F Upper	1SDA074094R1		1SDA074095R1	
E2.2	F	2500	Kit F Lower	1SDA074096R1		1SDA074097R1	
E4.2	W	3200	Kit Adjustable HR/VR	1SDA074019R1		1SDA074020R1	
E4.2	W	4000	Kit Adjustable HR/VR	1SDA074025R1		1SDA074026R1	
E4.2	W	4000	Kit F Upper	1SDA074102R1		1SDA074103R1	
E4.2	W	4000	Kit F Lower	1SDA074104R1		1SDA074105R1	
E4.2	W	4000	Kit FL	1SDA074079R1		1SDA074080R1	
E6.2	W	5000	Kit Adjustable HR/VR	1SDA074033R1		1SDA074034R1	
E6.2/f	W	5000	Kit Adjustable HR/VR			1SDA074035R1	
E6.2	W	6300	Kit Adjustable HR/VR	1SDA074042R1		1SDA074043R1	
E6.2/f	W	6300	Kit Adjustable HR/VR			1SDA074044R1	
E6.2	W	6300	Kit F Upper	1SDA074112R1		1SDA074113R1	
E6.2	W	6300	Kit F Lower	1SDA074115R1		1SDA074116R1	
E6.2/f	W	6300	Kit F Upper			1SDA074114R1	
E6.2/f	W	6300	Kit F Lower			1SDA074117R1	
E6.2	W	6300	Kit FL	1SDA074087R1		1SDA074088R1	
E6.2/f	W	6300	Kit FL			1SDA074089R1	

Contact us

ABB SACE

A division of ABB S.p.A.

L.V. Breakers

Via Baioni, 35

24123 Bergamo

Phone: +39 035 395.111

Fax: +39 035 395.306-433

www.abb.com

The data and illustrations are not binding. We reserve the right to modify the contents of this document on the basis of technical development of the products, without prior notice.

Copyright 2014 ABB. All rights reserved.

1SDC200023D0203 - 2014.05 - x.000 CAL