



# Inora

Simplicity for timeless design



- Simple and elegant design: curved rocker combined with chamfer frame on the top and the bottom
- Backlight with blue illumination
- Safe and faster installation due to ergonomic design
- Durability thanks to high-quality materials
- Socket outlets designed with safety shutter to protect children from power hazards

# Inora

## Simplicity for timeless design

Inora's simple and elegant design perfectly complements the interior of any residential or commercial building. With its functional simplicity it creates a timeless aesthetic.

simplicity

Less is more. With clean lines, gently curved rockers, and stylish chamfer frames on the top and bottom the Inora range is infinitely sophisticated. The unobtrusive design coordinates effortlessly with any interior design scheme. Or if you would like to turn your light switch into a striking design element, you can opt for a back-light with blue illumination.

Form follows function. The Inora range of light switches and wiring accessories has been

designed with quality, functionality, and simplicity in mind. Many functions such as USB charging ports have been combined into one product, saving space, and optimizing installation and use. As a result, fewer wiring accessories are needed throughout the building, which also contributes to a clean interior design.

The Inora range of light switches and wiring accessories has been designed with quality, functionality and simplicity in mind.



timeless

—  
Available in four colors – white,  
classic grey, starry black and royal  
gold – the simplicity of the Inora  
switches and socket outlets sets  
new standards for timeless  
design.

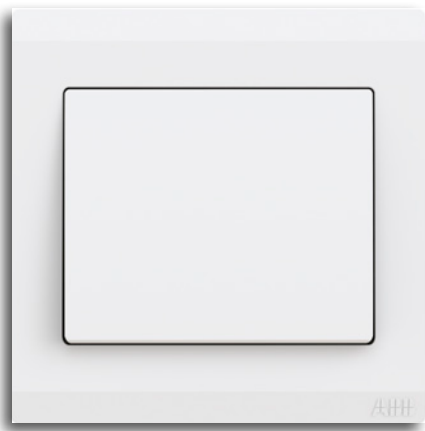
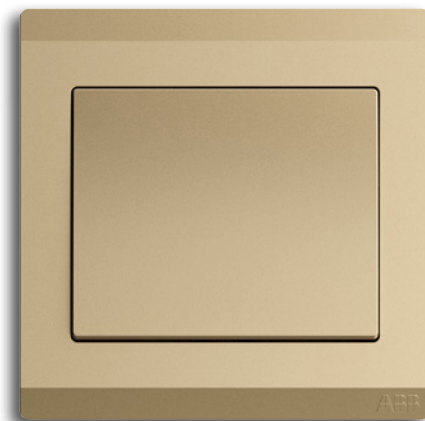
—  
01—  
02—  
03—  
04

ess

—  
01 White  
—  
02 Classic grey - G  
—  
03 Starry black - 885  
—  
04 Royal gold - PG

# Inora

## Your first choice, simple and elegant

Whether it's in a kitchen, a living room or a child's room, with a total above-wall switch height of 8.5 mm, Inora is your first choice, simple and elegant.

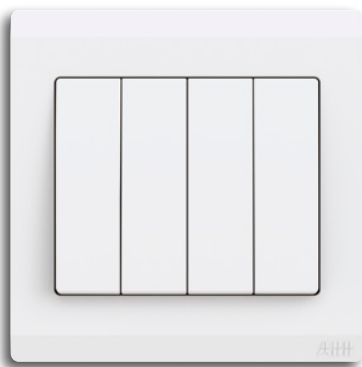

01

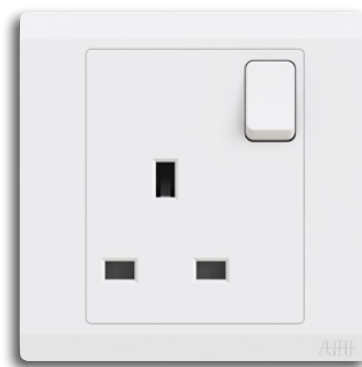

02

- 01 White switch
- 02 White socket

# Features & benefits

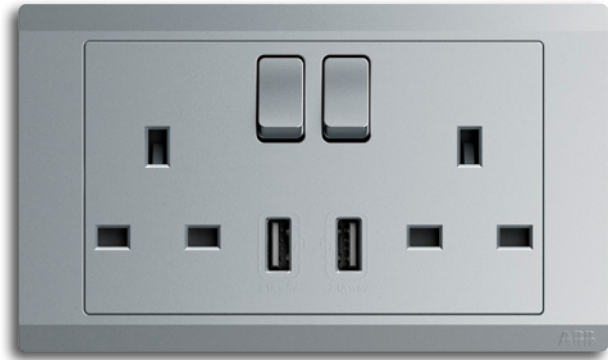

—  
Inora socket outlets  
with integrated  
USB charging

# benefits

## Wide range

The Inora range covers the main needs of modern electrical installation.

- From standard switches, socket outlets, dimmers, cooker control units to sockets with integrated USB charging ports
- Wide variety of data communication outlets

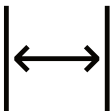

## Safety

ABB attaches great importance to safety. The Inora range has been certified according to British Standard installations.

- Socket outlets have been designed with safety shutters to protect children from power hazards
- Subtle blue illumination for simple location at night



## Durability

Inora is designed to be timeless, not only in terms of its design but also in terms of quality.

- High-quality polycarbonate materials for both surface and installation parts
- High-quality red copper and silver alloy materials for metals parts to optimize performance



## Easy installation

Space optimization and installation efficiency.

- Safe and faster installation due to ergonomic design
- Up to four rockers in 1gang frame, providing a cost-effective and space-saving solution





—  
Designed to provide reliability, durability and safety, Inora is the affordable range of light switches and wiring accessories – the perfect fit for any type of residential or commercial buildings.

# elegant



# Product overview

## Switches

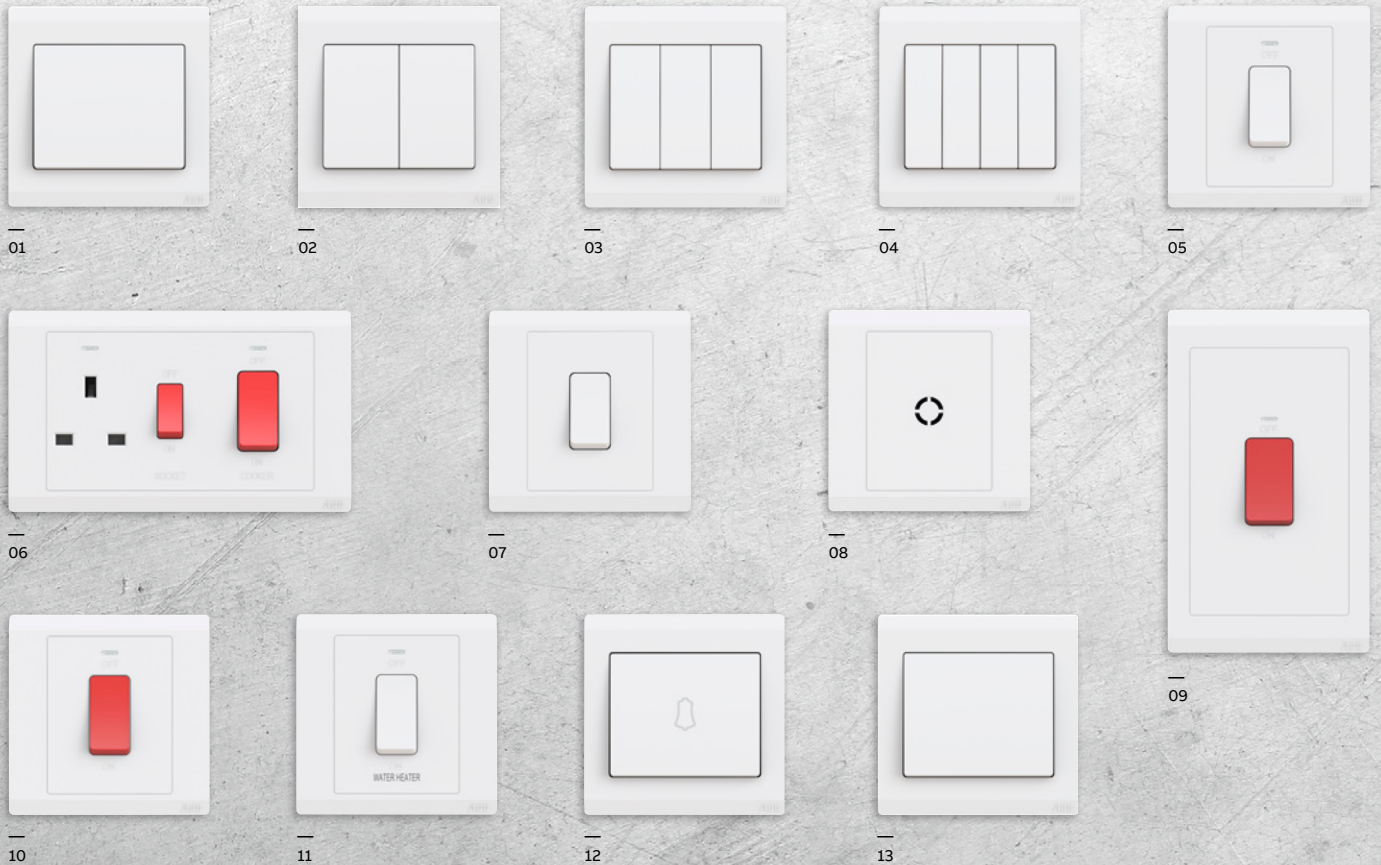

See product picture	Order Code	Type	Description	Technical Data	Flush-mounted Box Dimension
<b>Switches</b>					
01	2TCZ171001R0030	BL101	1gang 1way 10 AX switch	10 AX	35 mm
02	2TCZ171003R0030	BL102	2gang 1way 10 AX switch	10 AX	35 mm
03	2TCZ171005R0030	BL103	3gang 1way 10 AX switch	10 AX	35 mm
04	2TCZ171007R0030	BL104	4gang 1way 10 AX switch	10 AX	35 mm
01	2TCZ171002R0030	BL105	1gang 2way 10 AX switch	10 AX	35 mm
02	2TCZ171004R0030	BL106	2gang 2way 10 AX switch	10 AX	35 mm
03	2TCZ171006R0030	BL107	3gang 2way 10 AX switch	10 AX	35 mm
04	2TCZ171008R0030	BL108	4gang 2way 10 AX switch	10 AX	35 mm
05	2TCZ171020R0070	BL111S	1gang 1way 20 A DP switch with illumination	20 A	35 mm
06	2TCZ171015R0090	BL118	2gang 1way 45 A DP switch & 13 A switched socket with illumination	45 A/13 A	35 mm
07	2TCZ171021R0030	BL119S	1gang intermediate 10 AX switch	10 AX	35 mm
08	2TCZ171099R0070	BL120	20 A Flex outlet	20 A	35 mm
09	2TCZ171019R0090	BL143	1gang 45 A DP switch with illumination (6X3)	45 A	35 mm
11	2TCZ171012R0075	BL171WH	1gang 1way 20 A DP SW with illumination-marked water heater	20 A	35 mm
10	2TCZ171013R0090	BL176	1gang 1way 32 A DP switch with illumination	32 A	35 mm
10	2TCZ171098R0090	BL179	1gang 1way 45 A DP switch with illumination	45 A	35 mm
12	2TCZ171011R0030	BL429	1gang 1way 10 A push switch-marked BELL	10 A	35 mm
13	2TCZ171010R0030	BL430	1gang 1way 10 A push switch	10 A	35 mm

# Product overview

## Socket outlets

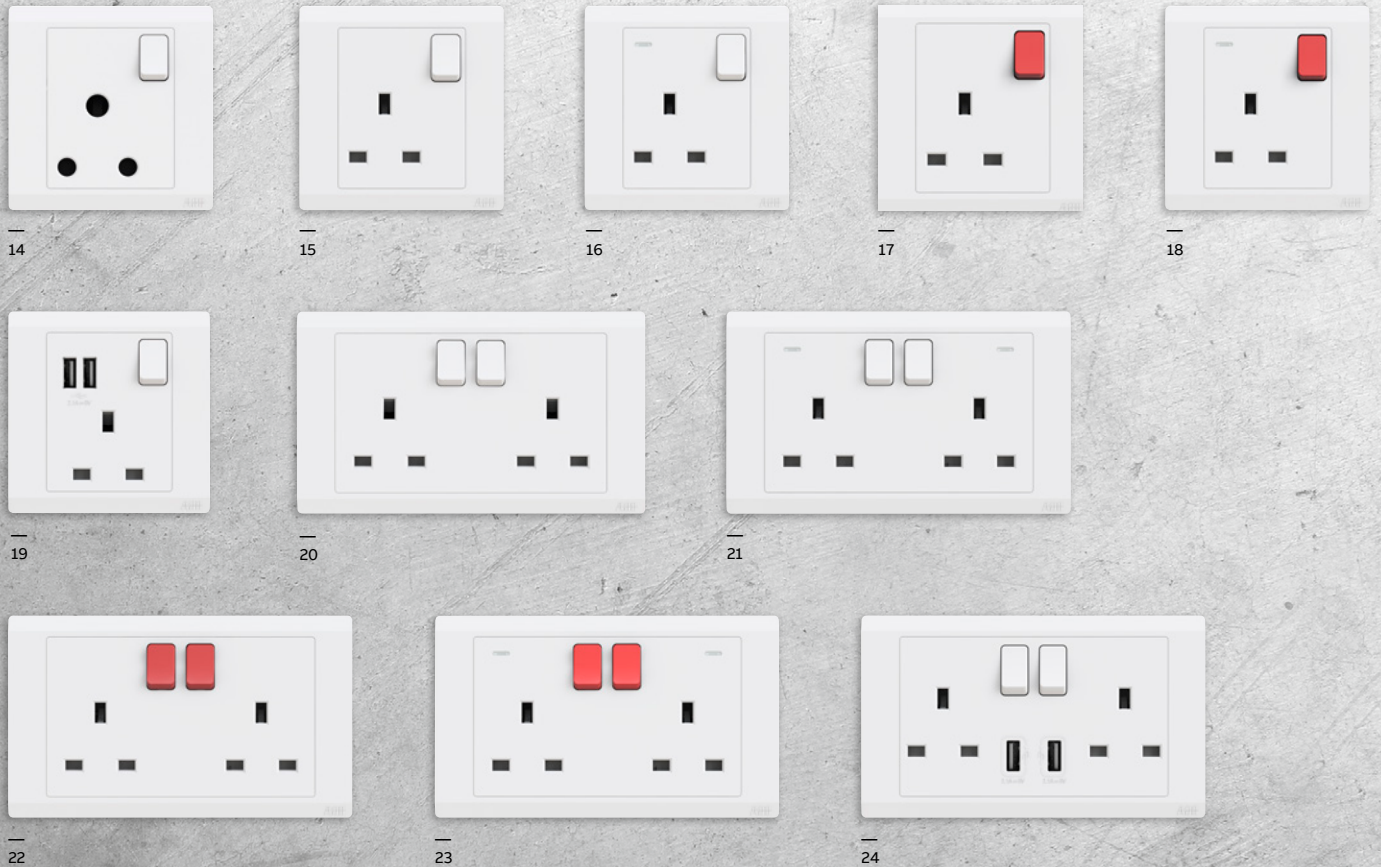

See product picture	Order Code	Type	Description	Technical Data	Flush-mounted Box Dimension
<b>Socket</b>					
14	2TCZ172012R0050	BL209	1gang 15 A switched socket SP	15 A	35 mm
18	2TCZ172020R0040	BL213	1gang 13 A switched socket SP with red rocker & illumination	13 A	35 mm
17	2TCZ172019R0040	BL214	1gang 13 A switched socket SP with red rocker	13 A	35 mm
22	2TCZ172021R0040	BL215	2gang 13 A switched socket SP with red rocker	13 A	35 mm
15	2TCZ172001R0040	BL224	1gang 13 A switched socket SP	13 A	35 mm
20	2TCZ172010R0040	BL227	2gang 13 A switched socket SP	13 A	35 mm
16	2TCZ172002R0040	BL229	1gang 13 A switched socket SP with illumination	13 A	35 mm
21	2TCZ172011R0040	BL230	2gang 13 A switched socket SP with illumination	13 A	35 mm
23	2TCZ172094R0040	BL236	2gang 13 A switched socket SP with red rocker & illumination	13 A	35 mm
15	2TCZ172095R0040	BL237	1gang 13 A switched socket DP	13 A	35 mm
16	2TCZ172096R0040	BL238	1gang 13 A switched socket DP with illumination	13 A	35 mm
20	2TCZ172097R0040	BL239	2gang 13 A switched socket DP	13 A	35 mm
21	2TCZ172098R0040	BL240	2gang 13 A switched socket DP with illumination	13 A	35 mm
19	2TCZ172016R0040	BL261	1gang BS switched socket DP with USB, type A*2	13 A	47 mm
24	2TCZ172017R0040	BL262	2gang BS switched socket DP with USB, type A*2	13 A	47 mm



# Product overview

## Data outlets/FCU & Flex outlets/Accessories

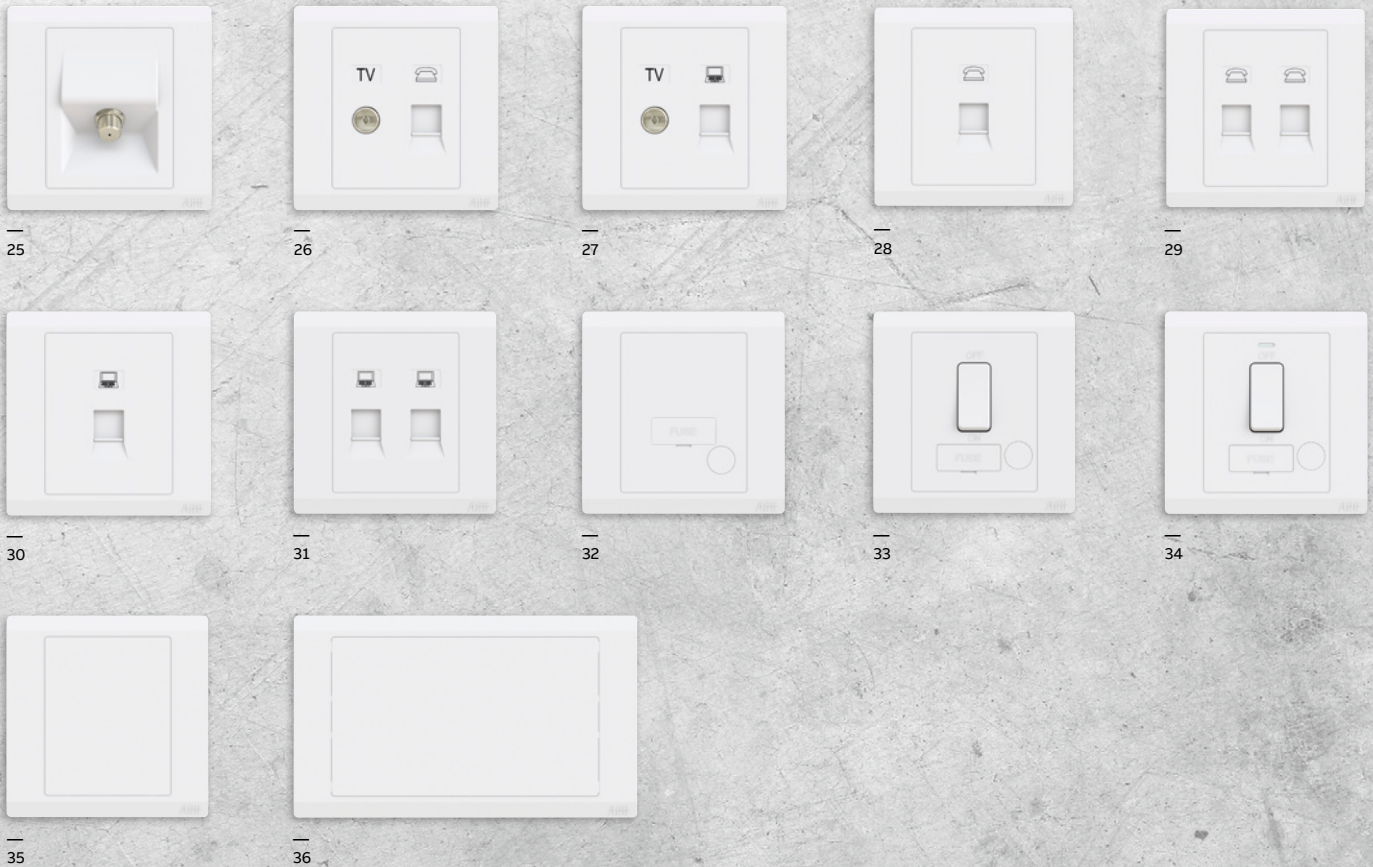

See product picture	Order Code	Type	Description	Technical Data	Flush-mounted Box Dimension
<b>Data outlets</b>					
25	2TCZ173099R0010	BL308	1gang SAT outlet - 45 degree	F-type	35 mm
31	2TCZ173019R0010	BL317	2gang data outlet RJ45 Cat.6a	RJ45 Cat.6a	35 mm
30	2TCZ173020R0010	BL318	1gang data outlet RJ45 Cat.6a	RJ45 Cat.6a	35 mm
28	2TCZ173006R0010	BL321	1gang telephone outlet RJ11	RJ11	35 mm
29	2TCZ173012R0010	BL322	2gang telephone outlet RJ11	RJ11	35 mm
26	2TCZ173010R0010	BL324	2gang TV/ telephone outlet	5-1000MHz RJ11	35 mm
27	2TCZ173016R0010	BL325	2gang TV/ data outlet RJ45 Cat.5e	5-1000MHz RJ45 Cat.5e	35 mm
31	2TCZ173014R0010	BL329	2gang data outlet RJ45 Cat.6	RJ45 Cat.6	35 mm
30	2TCZ173007R0010	BL331	1gang data outlet RJ45 Cat.5e	RJ45 Cat.5e	35 mm
30	2TCZ173017R0010	BL331-H	1gang data outlet housing	-	35 mm
31	2TCZ173013R0010	BL332	2gang data outlet RJ45 Cat.5e	RJ45 Cat.5e	35 mm
31	2TCZ173018R0010	BL332-H	2gang data outlet housing	-	35 mm
30	2TCZ173008R0010	BL333	1gang data outlet RJ45 Cat.6	RJ45 Cat.6	35 mm
<b>FCU &amp; Flex outlets</b>					
32	2TCZ175003R0040	BL506	1gang 13 A unswitch fused connection unit	13 A 250 V~	35 mm
34	2TCZ175004R0040	BL507	1gang 13 A switch fused connection unit with illumination	13 A 250 V~	35 mm
33	2TCZ175099R0040	BL508	1gang 13 A switch fused connection unit	13 A 250 V~	35 mm
<b>Accessories</b>					
35	2TCZ175001R0010	BL504	1gang Blank plate	-	35 mm
36	2TCZ175002R0010	BL505	2gang Blank plate	-	35 mm

# Product Technical Information

## Dimensions

Dimensions for 1gang frames

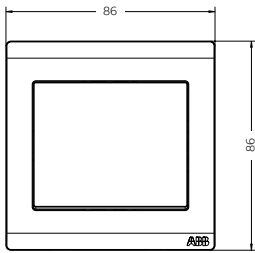

Distance between fixing screws for 1gang frames

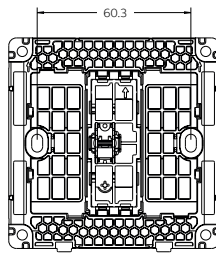

Dimensions for 2gang frames

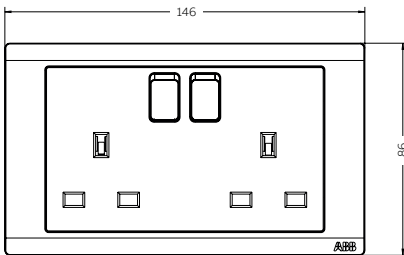

Distance between fixing screws for 2gang frames

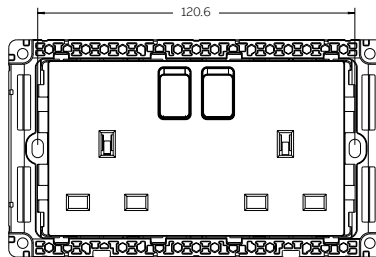

Dimensions for 1gang 45A DP switch (6x3)

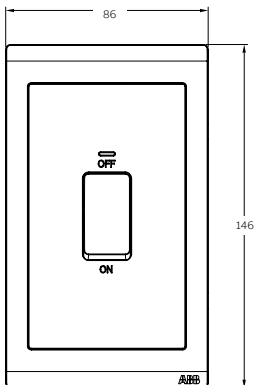

Distance between fixing screws for 45A DP switch (6x3)

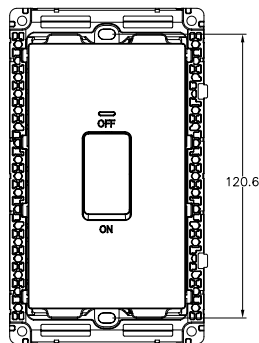

# Product Technical Information

## Wiring Diagrams

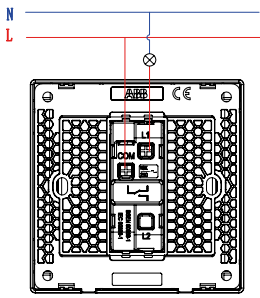

1G 1W switch

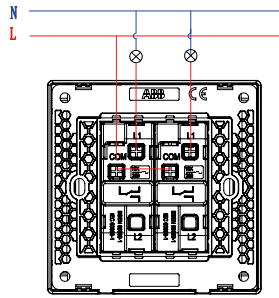

2G 1W switch

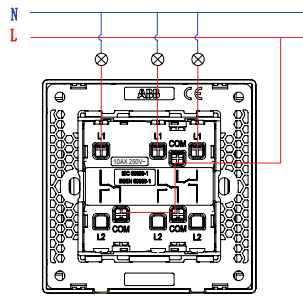

3G 1W switch

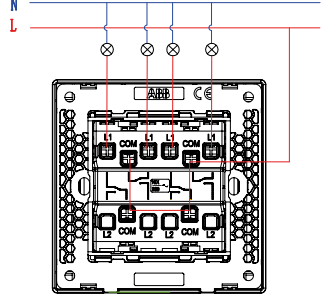

4G 1W switch

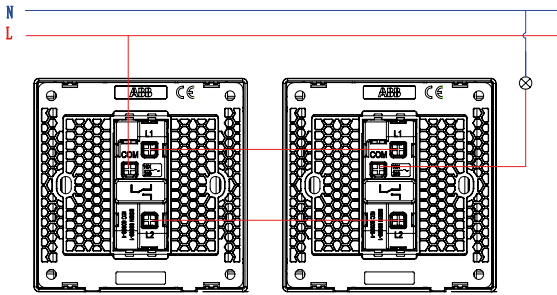

1G 2W switch

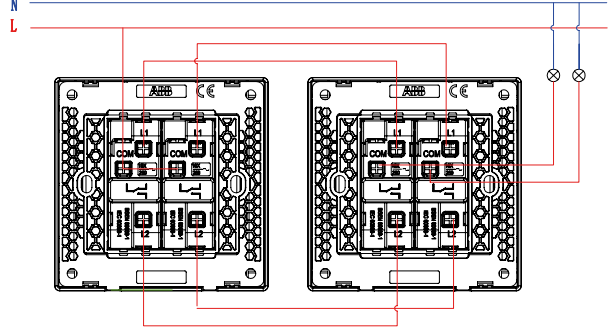

2G 2W switch

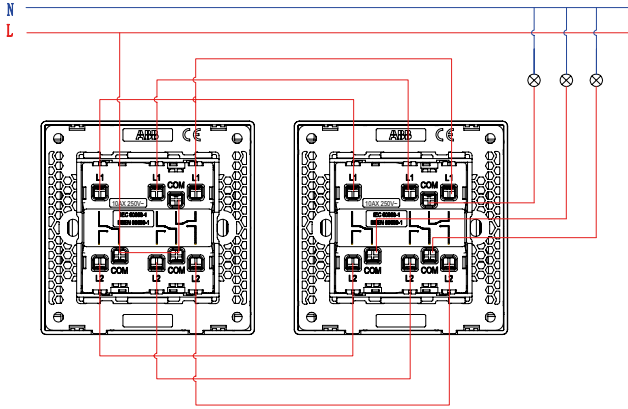

3G 2W switch

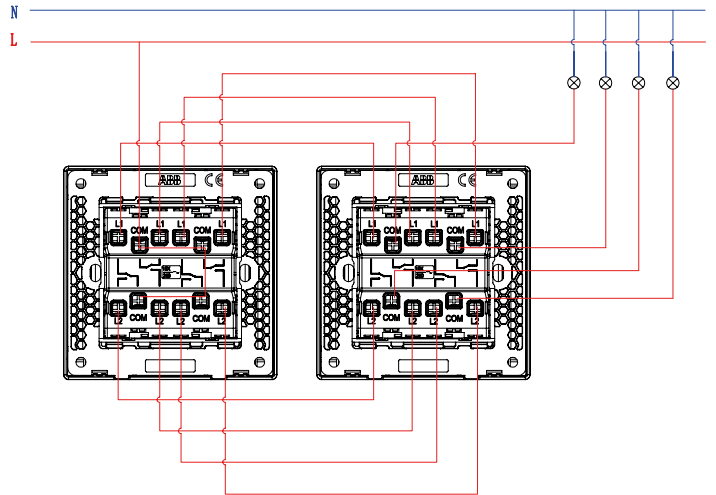

4G 2W switch

# Product Technical Information

## Wiring Diagrams

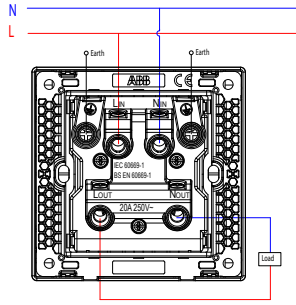

1G 1W switch 20 A DP

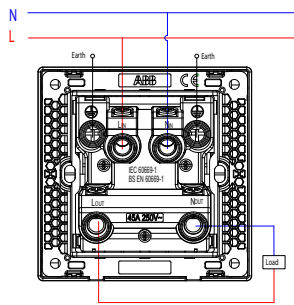

1G 1W 32/45 A switch DP

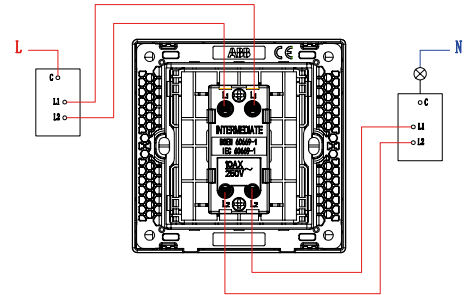

1G intermediate switch

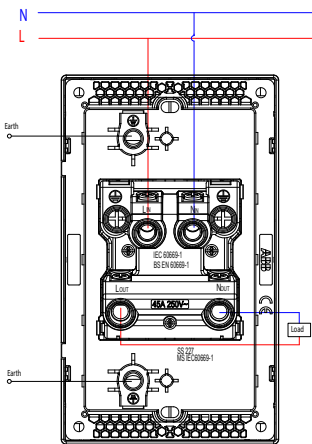

1G 1W 45A switch DP

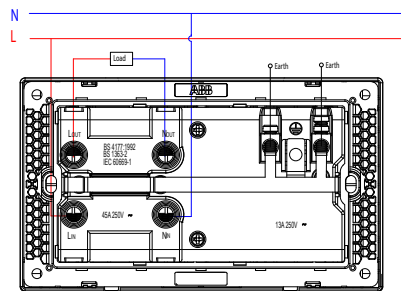

Cooker control unit

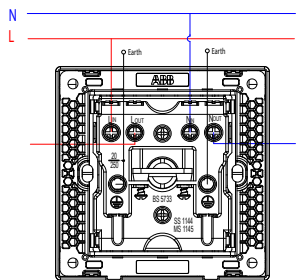

Flex outlet 20 A

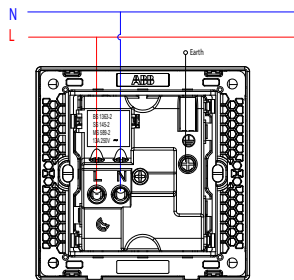

1G 13 A switched socket outlet

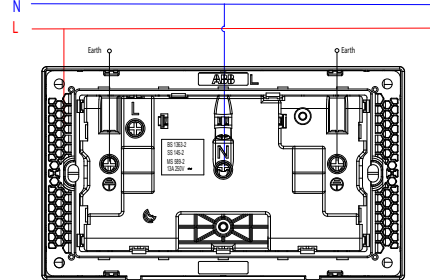

2G 13 A switched socket outlet

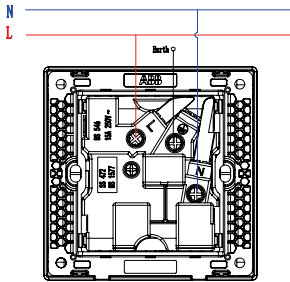

1G 15 A switched socket outlet

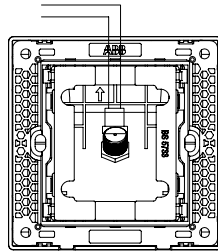

1G TV outlet

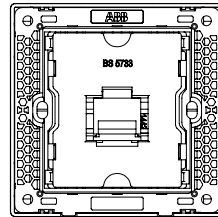

1G telephone outlet

**WIRING DIAGRAM**

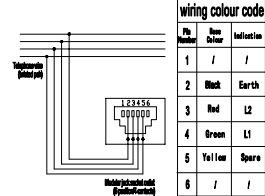

Pin Number	Wire Colour	Function
1	/	/
2	Black	Earth
3	Red	L2
4	Green	L1
5	Yellow	Spare
6	/	/

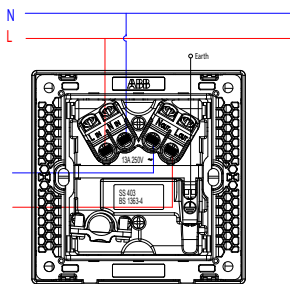

Fused connection unit

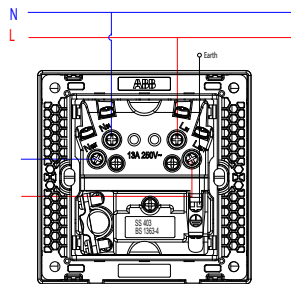

Fused switched connection unit

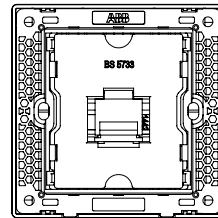

1G/2G data outlet

**WIRING DIAGRAM**

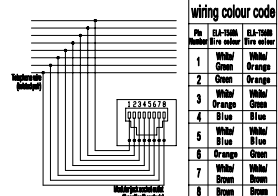

Pin Number	ELV-100V Fire wire	ELV-250V Fire wire
1	White/Green	White/Orange
2	Green	Orange
3	White/Orange	White/Green
4	Blue	Blue
5	White/Blue	White/Blue
6	Orange	Green
7	White/Brown	White/Brown
8	Brown	Brown

# Product Standards

Product description	Standard	Description
Switches	IEC60669-1 / BSEN60669-1 / SS 227 / MSIEC60669-1	Switches for household and similar fixed electrical installations
Cooker control unit	BS4177	Specification for Cooker control units
	IEC60669-1	Switches for household and similar fixed electrical installations
	BS1363-2 / SASO 2203	Specification for 13 A switched and unswitched socket outlets Standard for Cooker control units
13 A sockets	BS1363-2 / SS 145-2 / SASO 2203 / MS 589-2	Specification for 13 A switched and unswitched socket outlets
15 A sockets	BS546 / SS472 / MS1577	Two-pole and earthing-pin plugs, socket outlets and socket outlet adaptors
Dimmer/Fan regulator	IEC60669-2-1	Switches for household and similar fixed electrical installations
Telecommunication	BS5733	General requirements for electrical accessories
Fused Connection Unit	BS 1363-4 / SS403	Specification for 13 A fused connection units switched and unswitched
Flex outlet 20 A/45 A	BS 5733 / MS1144 / MS1145	General requirements for electrical accessories
Plates	BS5733	General requirements for electrical accessories



# Contacts

—

## UAE

### ABB Industries LLC

Al Quoz Industrial Area 3  
4th Interchange, St. No: 4 Dubai  
Phone: 0097 1 (4) 3147500

—

## Saudi Arabia

### ABB Electrical Industries Co. Ltd.

Al Ahsa Street, Malaz 11371, Riyadh  
Phone: 00966 11 4845600

—

## Qatar

### ABB LLC

Al Asmakh Tower, 15th floor  
864 Hazm Zraig St., Bldg No. 49  
Zone 63, Onaiza District, West Bay  
PO BOX 8688  
Phone: +974 4425 3888

—

## Kuwait

### ABB Engineering Technologies Co. (KSCC)

Alghunaim Commercial Twr, 2nd Flr, Al-Qibla Area  
P.O.Box 4275, Safat-13043,  
Abu Baker Al-Sadique Street  
Phone: +965 2428626

—

## Bahrain

### ABB Technologies W.L.L.

Gulf Executive Offices, 12/Flr. Office 1023  
Entrance 15, Road 3801, AlGudaibiya 338  
Phone : +973 17810659

—

## Oman

### ABB LLC

218, Hatat House, P. O. Box 778,  
131 Al Hamriya Muscat  
Phone: 00968 24 567 410

—

## Jordan

### ABB Ltd.

Wasfi Altal Street - Building 356 - Khalda  
P.O Box 926098 Amman 11190  
Phone: +962 (6) 5507733

—

## Pakistan

### ABB Power & Automation (Pvt) Ltd.

P.E.C. Building, 97-A/D-1,  
Liberty Market, Gulberg-III,  
P.O. 2353, Lahore-54660, Pakistan  
Phone: +92-42-32560740

—

## Nigeria

### ABBNG Limited

Plot 8C Metalbox road, off Acme  
road Ogba, Ikeja, Lagos, Nigeria  
Mob./WhatsApp:+234(0)7016824616  
Email: ahmed.gamal@ng.abb.com

—

## Sri Lanka

### Asea Brown Boveri Lanka (Pvt) Limited

Level 35, West Tower, World Trade Center  
Colombo 00100  
Phone: +94 77 789 6445  
ranjan.weemanna@lk.abb.com

—

## Bangladesh

ABB Limited, The Glass House,  
38 Gulshan Avenue (12th Floor)  
Dhaka -1212  
Phone: +88 02 98 56468 / 53412

—

## Singapore

### ABB Pte. Ltd.

2, Ayer Rajah Crescent  
SGP - 139935  
Phone: +65 6 776 5711

—

## Malaysia

### ABB Malaysia Sdn Bhd

Lot 608, Jalan Lagoon Selatan,  
47500 Subang Jaya, Selangor.  
Phone: +603 5628 4888

—

## Vietnam

### ABB Automation and Electrification (Vietnam) Company Ltd

12th Floor, REE tower, 9 Doan Van Bo street,  
12th ward, 4 District, Ho Chi Minh City  
Phone: +8428 3943 1488

—

## Hong Kong

### ABB (Hong Kong) Limited

Offices E&F, 5/F YHC Tower,  
No. 1 Sheung Yuet Road, Kowloon Bay,  
Kowloon, Hong Kong  
Phone: +852 2929-3912

—

## United Kingdom

### ABB Limited

Tower Court  
Courtaulds Way, Coventry  
CV6 5NX  
Phone: 0044 (0)2476 368 500



—  
[new.abb.com/low-voltage/products/  
residential-products](https://new.abb.com/low-voltage/products/residential-products)