

Low voltage electrical distribution

Micrologic

Control units

2.0 A, 5.0 A, 6.0 A, 7.0 A

2.0 E, 5.0 E, 6.0 E

User manual

03/2012



Discover the
new Micrologic E
control unit!



Schneider
Electric

Discover the new Micrologic E control unit

The most affordable way to put
energy metering where you need it



Distributed energy metering is a critical first step to reducing energy consumption. It will help you understand exactly where, when, and how much energy you are consuming throughout your facilities so you can discover opportunities to improve your efficiency.

The new Micrologic E control unit for Compact NS and Masterpact NT/NW circuit breakers affordably combines protection, metering, and communications in a way that is smart, safe, and simple.

This will be an important first step toward a complete Active Energy Management programme that can often achieve up to 30 % in energy savings.



www.schneider-electric.com/micrologic-e

* As part of a complete Active Energy Management programme

Contents

Discovering your control unit	2
Model designations	2
Presentation	3
Protection settings	4
Setting procedure Using the portable test kit	4
Setting the Micrologic 2.0 A/E control unit	5
Setting the Micrologic 5.0 A/E control unit	6
Setting the Micrologic 6.0 A/E control unit	7
Setting the Micrologic 7.0 A control unit	8
Selecting the type of neutral protection	9
Discovering the functions	10
Current protection	10
Overload and fault indications	14
Measurements	15
Trip history and pre-alarms	17
Using the HMI	18
HMI display modes	18
Quick View mode (Micrologic E)	20
Tree Navigation mode	23
Maintenance	36
Resetting the fault indications - Checking and changing the battery	36
Testing the ground-fault and earth-leakage functions	37
Optional functions	38
Optional M2C contacts	38
Communication option	39
FDM121 front display module	41
Technical appendix	46
Tripping curves	46
Changing the long-time rating plug	48
Zone selective interlocking (ZSI)	49
Micrologic digital display	50
Thermal memory	51
Calculating demand values (Micrologic E)	52
RSU Remote Setting Utility	53
Measurement ranges and accuracy	55
Index	56

All Compact NS630-3200, Masterpact NT and Masterpact NW circuit breakers are equipped with a Micrologic control unit that can be changed on site. The control units are designed to protect power circuits and connected loads.

DB126368

Micrologic 2.0 E

X Y Z

- X: type of protection**
- 2 for basic protection
 - 5 for selective protection
 - 6 for selective + ground-fault protection
 - 7 for selective + earth-leakage protection.

Y: version number
identification of the control-unit generation. "0" signifies the first generation.

- Z: type of measurement**
- A for "ammeter"
 - E for "energy meter"
 - P for "power meter"
 - H for "harmonic meter"
 - no indication: no measurements

Note: In this document, A/E signifies A or E when characteristics are common to both Micrologic A and Micrologic E control units.

Micrologic 2.0 A and 2.0 E: basic protection

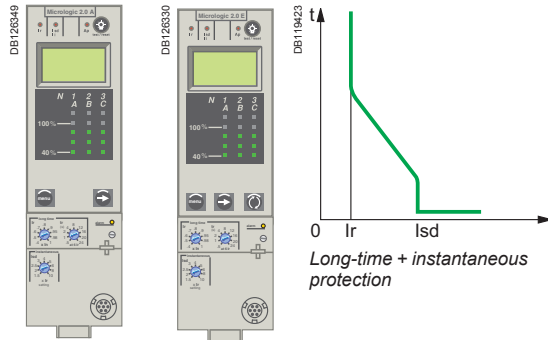

Micrologic 2.0 A Micrologic 2.0 E

Micrologic 5.0 A and 5.0 E: selective protection

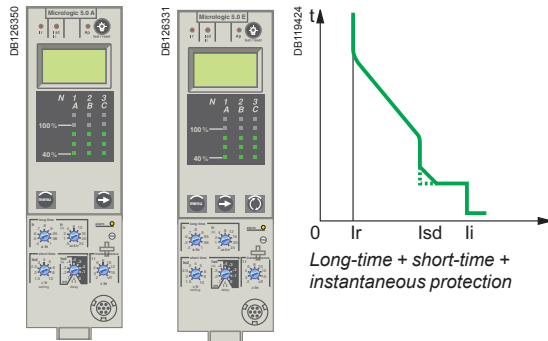

Micrologic 5.0 A Micrologic 5.0 E

Micrologic 6.0 A and 6.0 E: selective + ground-fault protection

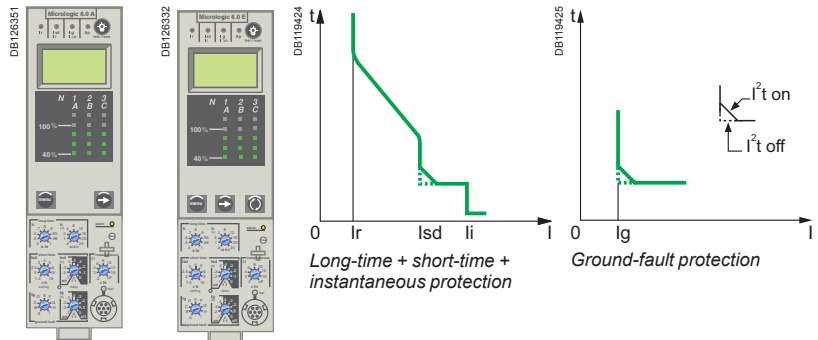

Micrologic 6.0 A Micrologic 6.0 E

Micrologic 7.0 A: selective + earth-leakage protection

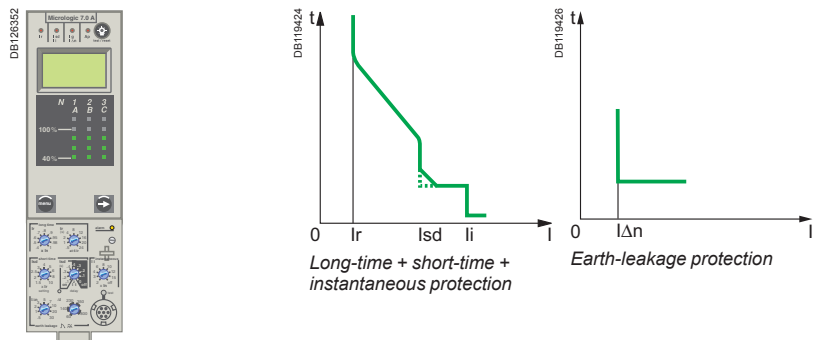

Micrologic 7.0 A

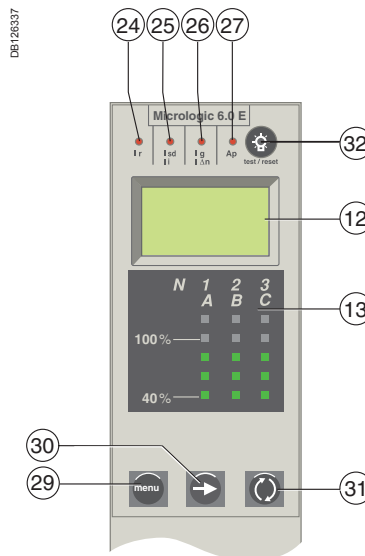
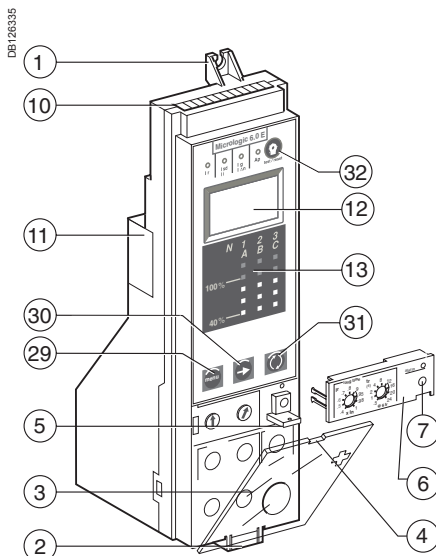
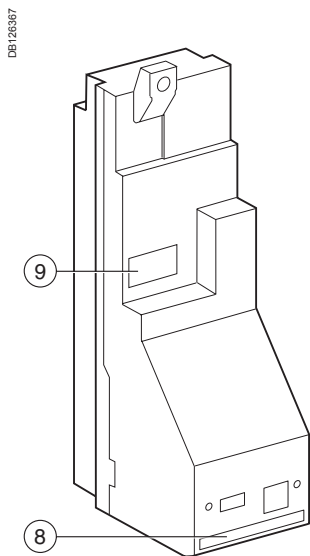

- 1 top fastener
- 2 bottom fastener
- 3 protective cover
- 4 cover opening point
- 5 lead-seal fixture for protective cover
- 6 long-time rating plug
- 7 screw for long-time rating plug
- 8 connection with circuit breaker
- 9 infrared link with communication interfaces
- 10 terminal block for external connections
- 11 battery compartment
- 12 digital display
- 13 three-phase bargraph and ammeter

Adjustment dials

- 14 long-time current setting I_r
- 15 long-time tripping delay t_r
- 16 short-time pickup I_{sd}
- 17 short-time tripping delay t_{sd}
- 18 instantaneous pick-up I_{sd}
- 19 instantaneous pick-up I_i
- 20 ground-fault pick-up I_g
- 21 ground-fault tripping delay t_g
- 22 earth-leakage pick-up $I_{\Delta n}$
- 23 earth-leakage tripping delay Δt

Indications

- 24 LED indicating long-time tripping
- 25 LED indicating short-time tripping
- 26 LED indicating ground-fault or earth-leakage tripping
- 27 LED indicating auto-protection tripping
- 28 LED indicating an overload

Navigation

- 29 menu selection button
- 30 menu scroll button
- 31 "Quick View" navigation button (Micrologic E only)
- 32 fault-trip reset and battery test button

Test

- 33 test button for ground-fault and earth-leakage protection
- 34 test connector

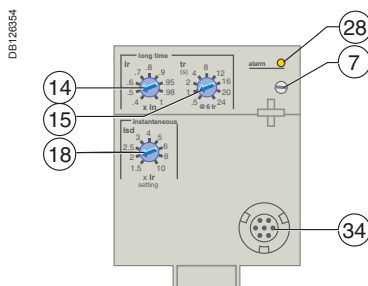

Micrologic 2.0 A/E

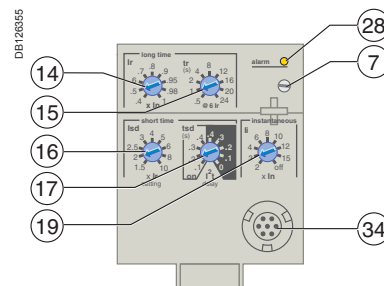

Micrologic 5.0 A/E

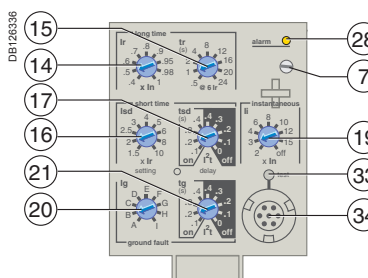

Micrologic 6.0 A/E

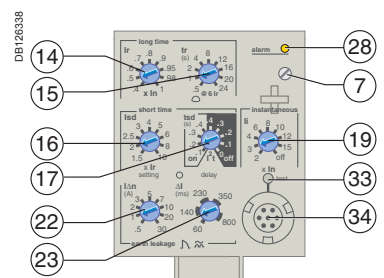

Micrologic 7.0 A

Setting procedure Using the portable test kit

Setting procedure

1. Open the protective cover.

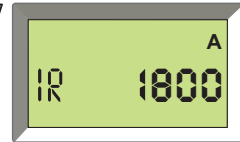
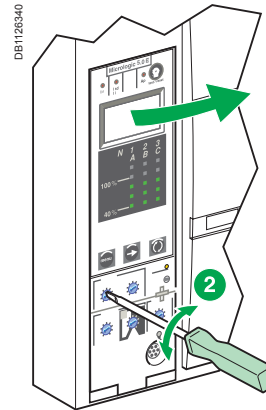
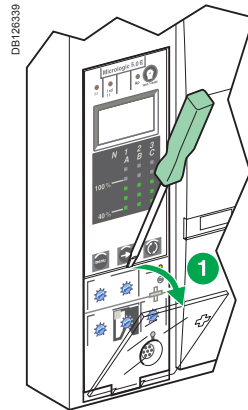

2. Select the desired setting.
The set value is automatically displayed on the digital screen in absolute value with the relevant units.

- Current in amperes (A and kA);
- Tripping delays in seconds.

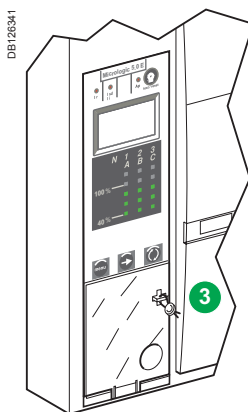

3. If no information is displayed, see "Micrologic digital display" in the technical appendix. If no further action is taken, the display returns to the main menu for current measurements after a few seconds.

4. Close the protective cover and, if necessary, install a lead seal to protect the settings.

See portable test kit user manual.

Using the portable test kit

To test the control unit, connect the portable test kit to the test connector.

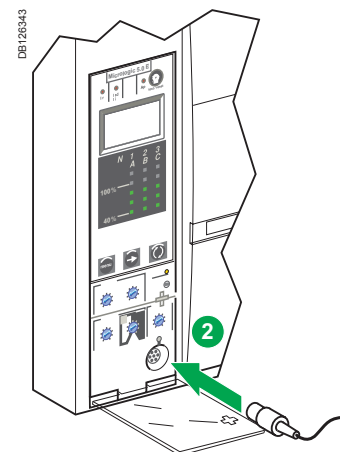
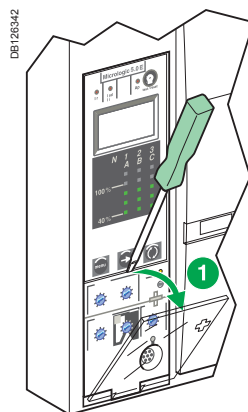

Setting the Micrologic 2.0 A/E control unit

See pages 10 to 12 for information on the available settings.

The rating of the circuit breaker in this example is 2000 A.

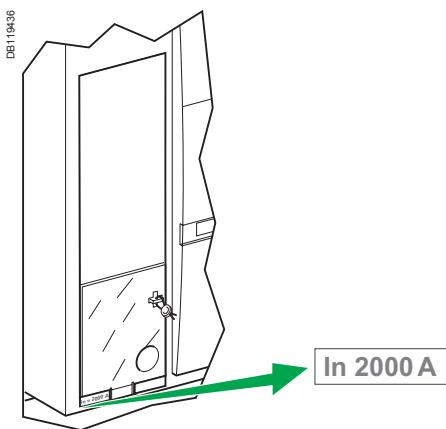

Set the threshold values

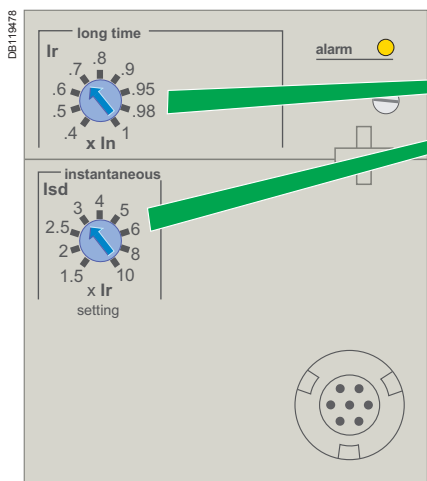

- In = 2000 A
- $I_r = 0.7 \times I_n = 1400 \text{ A}$
- $I_{sd} = 3 \times I_r = 4200 \text{ A}$

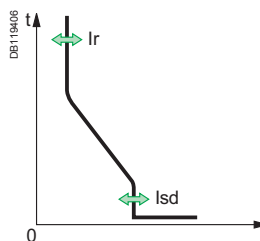

Set the tripping delays

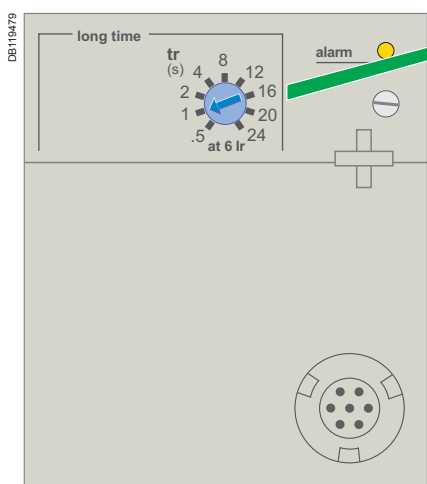

- tr = 1 s

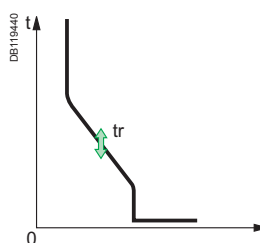

Setting the Micrologic 5.0 A/E control unit

See pages 10 to 12 for information on the available settings.

The rating of the circuit breaker in this example is 2000 A.

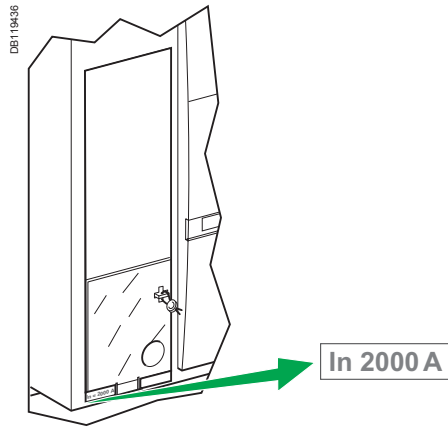

Set the threshold values

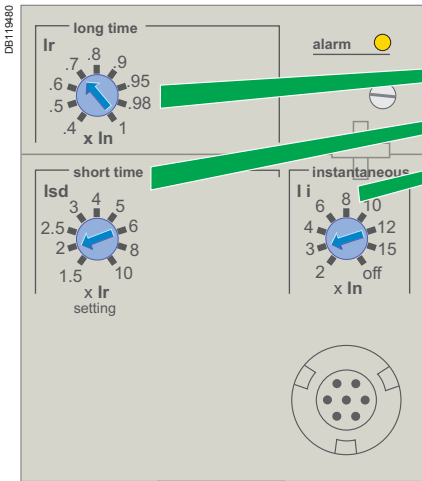

- $I_n = 2000 \text{ A}$
- $I_r = 0.7 \times I_n = 1400 \text{ A}$
- $I_{sd} = 2 \times I_r = 2800 \text{ A}$
- $I_i = 3 \times I_n = 6000 \text{ A}$

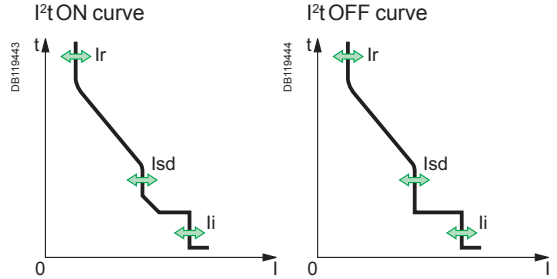

Set the tripping delays

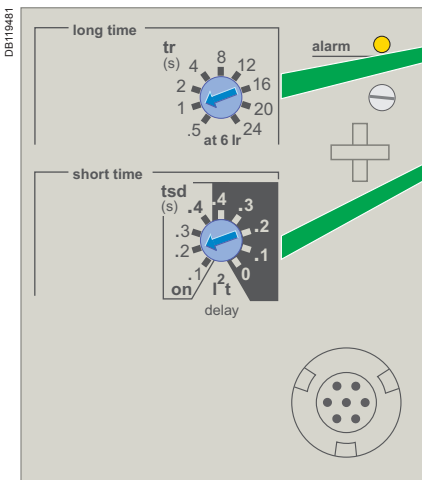

- $t_r = 1 \text{ s}$
- $t_{sd} = 0.2 \text{ s}$

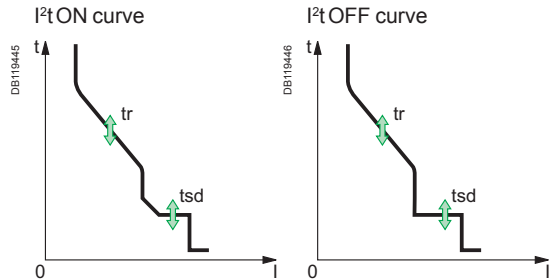

See pages 10 to 13 for information on the available settings.

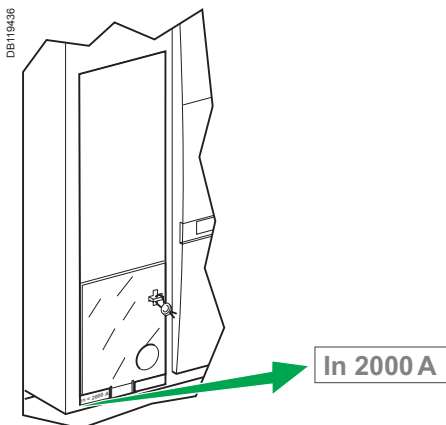

Set the threshold values

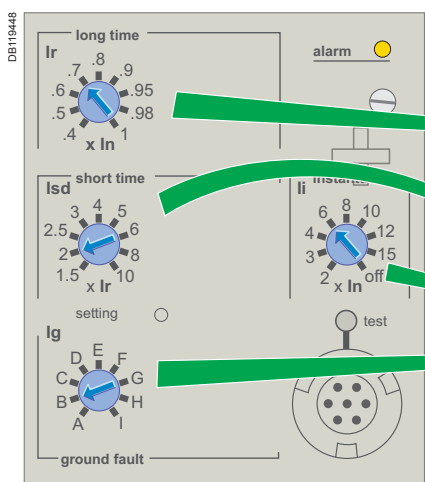

- In = 2000 A
- Ir = 0.7 x In = 1400 A
- Isd = 2 x Ir = 2800 A
- Ii = 3 x In = 6000 A
- B → Ig = 640 A

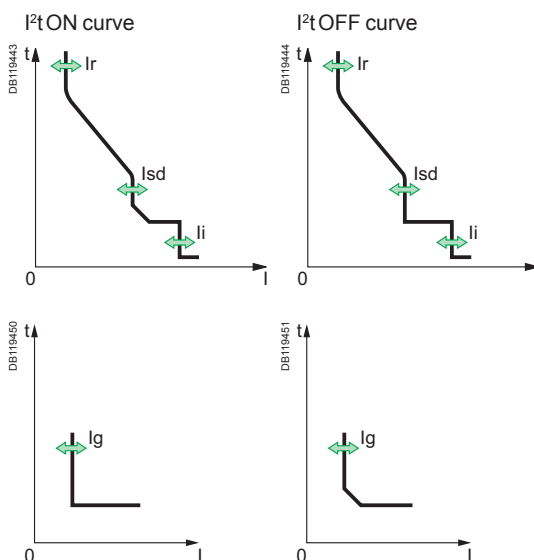

Set the tripping delays

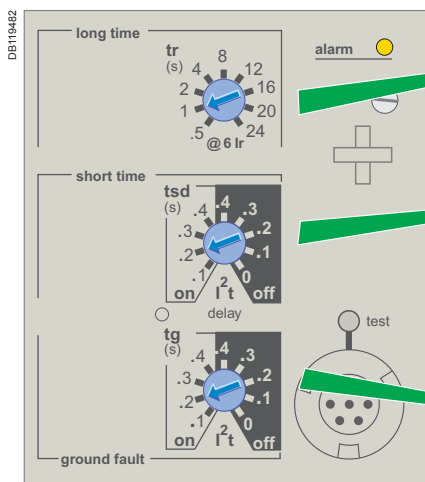

- tr = 1 s
- tsd = 0.2 s
- I²t on  I²t off
- tg = 0.2 s

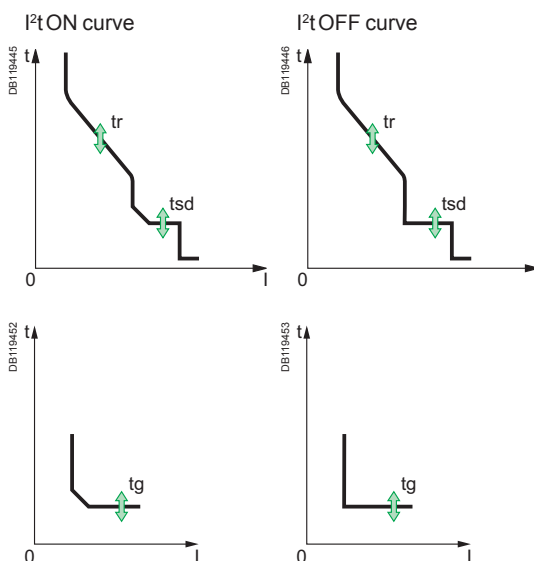

Setting the Micrologic 7.0 A control unit

See pages 10 to 13 for information on the available settings.

The rating of the circuit breaker in this example is 2000 A.

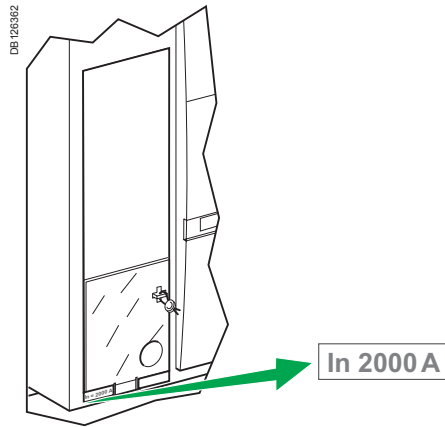

Set the threshold values

DB 126363

long time I_r .7 .8 9 .95 .5 .4 x I_n 1

short time I_{sd} 3 4 5 2.5 2 1.5 x I_r 10

setting $I_{\Delta n}$ (A) 3 5 7 10 1 20 1.5 30

alarm

test

earth leakage

$I_n = 2000 \text{ A}$

$I_r = 0.7 \times I_n = 1400 \text{ A}$

$I_{sd} = 2 \times I_r = 2800 \text{ A}$

$I_i = 3 \times I_n = 6000 \text{ A}$

$I_{\Delta n} = 1 \text{ A}$

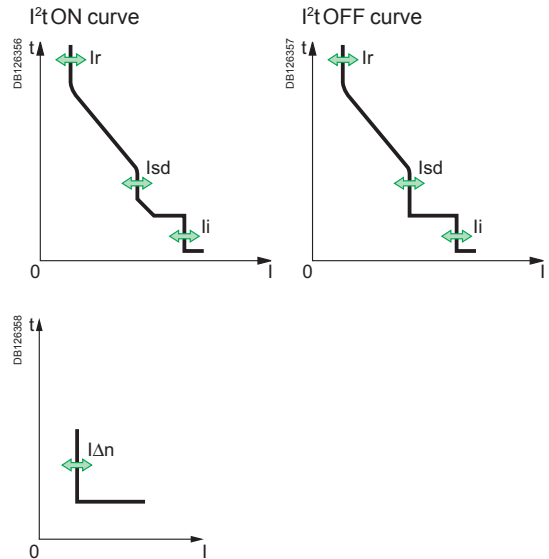

Set the tripping delays

DB 126364

long time t_r (s) 4 8 12 16 20 24 @ 5 I_r

short time t_{sd} (s) .4 .3 .2 .1 on I^2t off

delay Δt (ms) 230 350 140 60 800

alarm

test

earth leakage

$t_r = 1 \text{ s}$

$t_{sd} = 0.2 \text{ s}$

$\Delta t = 140 \text{ ms}$

I^2t on I^2t off

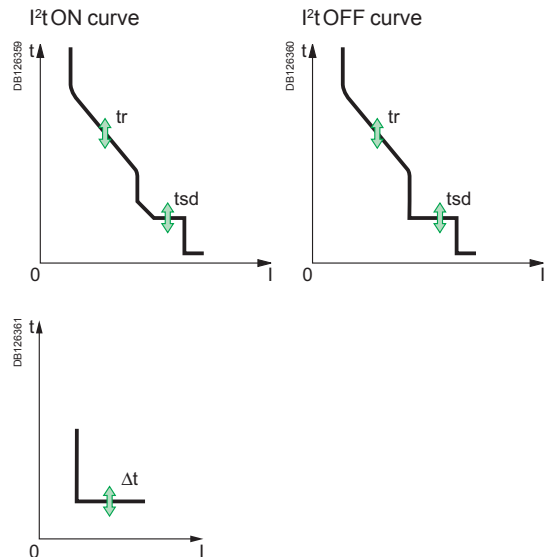

Selecting the type of neutral protection

On four-pole circuit breakers, it is possible to select the type of neutral protection for the fourth pole:

- neutral unprotected (4P 3D)
- neutral protection at $0.5 I_n$ (3D + N/2)
- neutral protection at I_n (4P 4D).

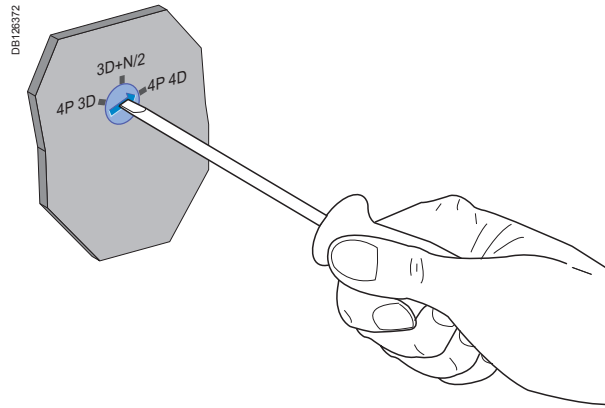

Current protection

Micrologic A and Micrologic E

Protection settings

You can set the tripping curve of your control unit to match the needs of your installation using the parameters presented below.

Micrologic 2.0 A/E

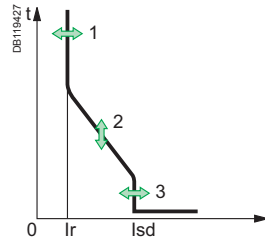

1. current setting I_r (long time)
2. tripping delay t_r (long time) for $6 \times I_r$
3. pick-up I_{sd} (instantaneous)

Micrologic 5.0 A/E, 6.0 A/E, 7.0 A

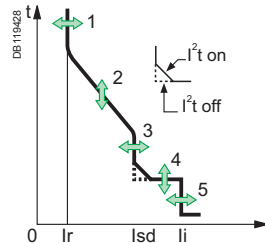

1. current setting I_r (long time)
2. tripping delay t_r (long time) for $6 \times I_r$
3. pick-up I_{sd} (short time)
4. tripping delay t_{sd} (short time)
5. pick-up I_i (instantaneous)

Micrologic 6.0 A/E

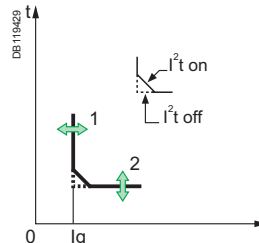

1. pick-up I_g (ground fault)
2. tripping delay t_g (ground fault)

Micrologic 7.0 A

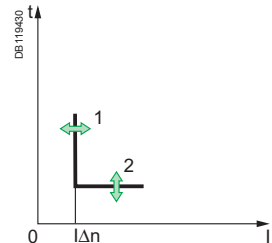

1. pick-up $I_{\Delta n}$ (earth leakage)
2. tripping delay Δt (earth leakage)

Long-time protection

The long-time protection function protects cables (phases and neutral) against overloads. This function is based on true rms measurements.

Thermal memory

The thermal memory continuously accounts for the amount of heat in the cables, both before and after tripping, whatever the value of the current (presence of an overload or not). The thermal memory optimises the long-time protection function of the circuit breaker by taking into account the temperature rise in the cables. The thermal memory assumes a cable cooling time of approximately 15 minutes.

Long-time current setting I_r and standard tripping delay t_r

Micrologic control unit	Accuracy	2.0 A/E, 5.0 A/E, 6.0 A/E and 7.0 A									
Current setting tripping between 1.05 and 1.20 x I_r	$I_r = I_n (*) \times \dots$	0.4	0.5	0.6	0.7	0.8	0.9	0.95	0.98	1	
		other ranges or disable by changing the long-time rating plug									
Time delay (s)	tr at 1.5 x I_r	0 to - 30 %	12.5	25	50	100	200	300	400	500	600
	tr at 6 x I_r	0 to - 20 %	0.5	1	2	4	8	12	16	20	24
	tr at 7.2 x I_r	0 to - 20 %	0.34	0.69	1.38	2.7	5.5	8.3	11	13.8	16.6

* I_n : circuit breaker rating.

The accuracy of the I_r setting may be enhanced by using a different long-time rating plug. See "Changing the long-time rating plug" in the technical appendix.

For the characteristics and external wiring of the zone selective interlocking function, see "Zone selective interlocking" in the technical appendix.

The portable test kit can be used to test the wiring between circuit breakers for the zone selective interlocking function.

Short-time protection

- The short-time protection function protects the distribution system against impedant short-circuits.
- The short-time tripping delay can be used to ensure discrimination with a downstream circuit breaker.
- This function carries out true rms measurements.
- The I²t ON and I²t OFF options enhance discrimination with downstream protection devices.
- Use of I²t curves with short-time protection:
 - I²t OFF selected: the protection function implements a constant time curve;
 - I²t ON selected: the protection function implements an I²t inverse-time curve up to 10 Ir. Above 10 Ir, the time curve is constant.
- Zone selective interlocking (ZSI).

The short-time and ground-fault protection functions enable time discrimination by delaying the upstream devices to provide the downstream devices the time required to clear the fault. Zone selective interlocking can be used to obtain total discrimination between circuit breakers using external wiring.

Short-time pick-up I_{sd} and tripping delay t_{sd}

Micrologic control unit		2.0 A/E, 5.0 A/E, 6.0 A/E and 7.0 A									
Pick-up	I _{sd} = I _r x ... accuracy ± 10 %	1.5	2	2.5	3	4	5	6	8	10	
Time delay (ms) at 10 I _r	settings	I ² t OFF	0	0.1	0.2	0.3	0.4				
		I ² t ON		0.1	0.2	0.3	0.4				
I ² t ON or	tsd (max resettable time)	20	80	140	230	350					
I ² t OFF	tsd (max break time)	80	140	200	320	500					

Instantaneous protection

- The instantaneous-protection function protects the distribution system against solid short-circuits. Contrary to the short-time protection function, the tripping delay for instantaneous protection is not adjustable.
- The tripping order is sent to the circuit breaker as soon as current exceeds the set value, with a fixed time delay of 20 milliseconds.
- This function carries out true rms measurements.

Instantaneous pick-up I_{sd}

Micrologic control unit		2.0 A/E								
Pick-up	I _{sd} = I _r x ... accuracy ± 10 %	1.5	2	2.5	3	4	5	6	8	10

Instantaneous pick-up I_i

Micrologic control unit		5.0 A/E, 6.0 A/E and 7.0 A								
Pick-up	I _i = I _n (*) x ... accuracy ± 10 %	2	3	4	6	8	10	12	15	OFF

* I_n: circuit-breaker rating

Current protection

Micrologic A and Micrologic E

Protection of the neutral conductor on four-pole circuit breakers

Protection of the neutral conductor depends on the distribution system. There are three possibilities.

Type of neutral	Description
Neutral unprotected	The distribution system does not require protection of the neutral conductor.
Half neutral protection (at 0.5 I _n)	<p>The cross-sectional area of the neutral conductor is half that of the phase conductors.</p> <ul style="list-style-type: none"> ■ The long-time current setting I_r for the neutral is equal to half the setting value. ■ The short-time pick-up I_{sd} for the neutral is equal to half the setting value. ■ The instantaneous pick-up I_{sd} (Micrologic 2.0 A/E) for the neutral is equal to half the setting value. ■ The instantaneous pick-up I_i (Micrologic 5.0 A/E / 6.0 A/E / 7.0 A) for the neutral is equal to the setting value.
Full neutral protection (at I _n)	<p>The cross-sectional area of the neutral conductor is equal to that of the phase conductors.</p> <ul style="list-style-type: none"> ■ The long-time current setting I_r for the neutral is equal to the setting value. ■ The short-time pick-up I_{sd} for the neutral is equal to the setting value. ■ The instantaneous pick-ups I_{sd} and I_i for the neutral are equal to the setting value.

Neutral protection for three-pole devices

Neutral protection is not available on three-pole devices.

Current protection

Micrologic 6.0 A/E, 7.0 A

Ground-fault protection on Micrologic 6.0 A/E

- A ground fault in the protection conductors can provoke local temperature rise at the site of the fault or in the conductors.
- The purpose of the ground-fault protection function is to eliminate this type of fault.
- There are two types of ground-fault protection.

Type	Description
Residual	<ul style="list-style-type: none"> ■ The function determines the zero-phase sequence current, i.e. the vector sum of the phase and neutral currents. ■ It detects faults downstream of the circuit breaker.
Source Ground Return	<ul style="list-style-type: none"> ■ Using a special external sensor, this function directly measures the fault current returning to the transformer via the earth cable. ■ It detects faults both upstream and downstream of the circuit breaker. ■ The maximum distance between the sensor and the circuit breaker is 10 m.

- Ground-fault and neutral protection are independent and can therefore be combined.

Ground-fault pick-up I_g and tripping delay t_g

The pick-up and tripping-delay values can be set independently and are identical for both the residual and "source ground return" ground-fault protection functions.

Micrologic control unit		6.0 A/E										
Pick-up	$I_g = I_n (*) \times \dots$ accuracy $\pm 10\%$	A	B	C	D	E	F	G	H	I		
	$I_n \leq 400\text{ A}$	0.3	0.3	0.4	0.5	0.6	0.7	0.8	0.9	1		
	$400\text{ A} < I_n \leq 1200\text{ A}$	0.2	0.3	0.4	0.5	0.6	0.7	0.8	0.9	1		
	$I_n > 1200\text{ A}$	500 A	640 A	720 A	800 A	880 A	960 A	1040 A	1120 A	1200 A		
Time delay (ms) at $10 I_n (*)$	settings	I^t OFF	0	0.1	0.2	0.3	0.4	I^t ON	0.1	0.2	0.3	0.4
	I^t ON or I^t OFF	t_g (max resettable time)	20	80	140	230	350	t_g (max break time)	80	140	200	320

* I_n : circuit-breaker rating

Earth-leakage protection on Micrologic 7.0 A

- The earth-leakage protection function primarily protects people against indirect contact because an earth-leakage current can provoke an increase in the potential of the exposed conductive parts. The earth-leakage pick-up value $I_{\Delta n}$ is displayed directly in amperes and the tripping delay follows a constant-time curve.
- An external rectangular sensor is required for this function.
- This function is inoperative if the long-time rating plug is not installed.
- $I_{\Delta n}$ protected against nuisance tripping.
- \hat{u}_{DC} -component withstand class A up to 10 A.

Pick-up value $I_{\Delta n}$ and tripping delay Δt

Micrologic control unit		7.0 A									
Pick-up	$I_{\Delta n}$ accuracy 0 to -20 %	0.5	1	2	3	5	7	10	20	30	
Time delay (ms)	settings										
	Δt (max resettable time)	60	140	230	350	800					
	Δt (max break time)	140	200	320	500	1000					

All Micrologic A and Micrologic E control units are equipped with overload and fault indication LEDs.

Overload LED

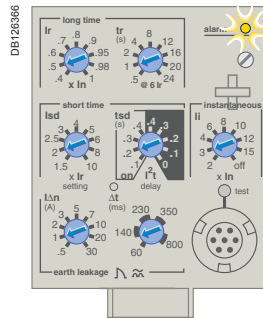

This LED signals that the long-time current setting I_r has been overrun.

Fault indications

Important

The battery maintains the fault indications. If there are no indications, check the battery.

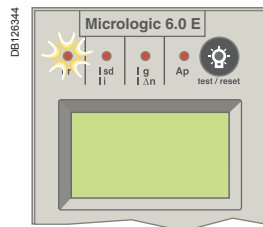

Signals tripping due to overrun of the long-time current setting I_r .

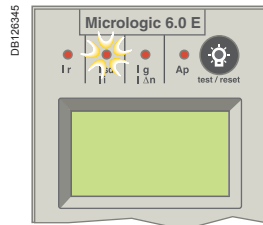

Signals tripping due to overrun of the short-time pick-up I_{sd} or instantaneous pick-up I_{sd} or I_i .

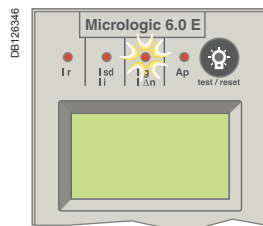

Signals tripping due to overrun of the ground-fault pick-up I_g or earth-leakage pick-up $I_{\Delta n}$.

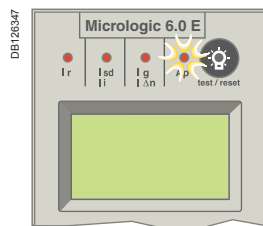

Signals tripping due to the auto-protection function of the control unit.

The auto-protection function (excessive temperature or short-circuit higher than circuit-breaker capacity) opens the circuit breaker and turns on the A_p LED.

Important

If the circuit breaker remains closed and the A_p LED remains on, contact the Schneider Electric after-sales support department.

Measurement and display possibilities

- Micrologic A measures instantaneous currents and stores the maximum values in maximeters.
- In addition to the values measured by Micrologic A, Micrologic E measures voltage, power and energy.

Micrologic A and Micrologic E measurements can be displayed on:

- the digital screen of the control unit (see page 24 for Micrologic A and page 25 for Micrologic E)
- an optional FDM121 Front Display Module (see page 41)
- a PC via the Modbus communication (COM) option (see page 38).

In addition, a bargraph on the front of the control unit continuously displays the currents measured on phases 1, 2 and 3 as a percentage of the long-time current setting I_r .

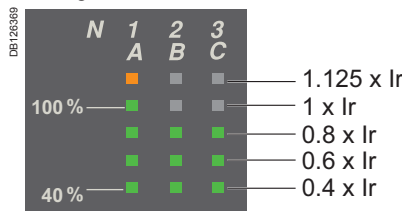

The following table indicates Micrologic A and Micrologic E measurement and display possibilities.

Measurements	Micrologic		Displayed on ...		
	A	E	Micrologic	FDM121	COM
Instantaneous currents $I_1, I_2, I_3, I_N, I_g (I_{\Delta N})^{(1)}$	■	■	■	■	■
Current maximeters $I_1 \max, I_2 \max, I_3 \max, I_N \max, I_g \max, (I_{\Delta N} \max)^{(1)}$	■	■	■	■	■
Demand current $I_1, I_2, I_3, I_N^{(1)}$		■	■	■	■
Demand current maximeters (peak demand) $\overline{I_1} \max, \overline{I_2} \max, \overline{I_3} \max, \overline{I_N} \max^{(1)}$		■		■	■
Phase-to-phase voltages V_{12}, V_{23}, V_{31} (3-wire and 4-wire systems)		■	■	■	■
Phase-to-neutral voltages V_{1N}, V_{2N}, V_{3N} (4-wire systems) ⁽²⁾		■	■	■	■
Average voltage V_{avg}		■		■	■
Voltage unbalance V_{unbal}		■		■	■
Instantaneous powers P, Q, S		■	■	■	■
Power maximeters $P_{max}, Q_{max}, S_{max}$		■		■	■
Demand active power \overline{P}		■	■	■	■
Demand apparent power \overline{S}		■		■	■
Demand power maximeter (peak demand) \overline{P}_{max}		■		■	■
Instantaneous power factor PF		■	■	■	■
Active energy E_p		■	■	■	■
Reactive and apparent energy E_q, E_s		■		■	■

⁽¹⁾ The display of the Neutral current (I_N) is available with Micrologic E when the parameter "type of network" has been set to 4 Wire 4ct (44). See page 32.

⁽²⁾ Important: for 3-pole circuit breakers used on 4-wire systems (3ph + N), terminal VN on the Micrologic control unit must always be connected to the neutral. If this is not done, the phase-to-neutral voltage measurements can be erroneous.

Note: If no information is displayed on the screen, see: "Micrologic digital display" in the technical appendix.

Measurement definitions

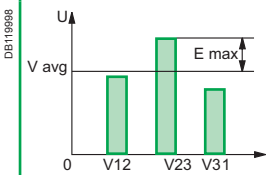
Measurements	Definition
Instantaneous current	The rms value of the instantaneous time current.
Neutral current	Available with a 4-pole breaker
Current maximeter	Maximum value of the instantaneous time current (refreshed every 500 ms) since Micrologic installation or last reset.
Demand current ⁽¹⁾	Mean of all instantaneous time current values over a given user-adjustable time interval (e.g. 10 min).
Voltage	The rms value of the voltage.
Average voltage	Average of the 3 phase-to-phase voltages V12, V23 and V31: $V_{avg} = \frac{V_{12} + V_{23} + V_{31}}{3}$
Voltage unbalance	Voltage unbalance on the most unbalanced phase, displayed as a percentage of Vavg.  <p>Micrologic E measures the maximum difference between the instantaneous time voltage of each phase and Vavg, and calculates the voltage unbalance: $V_{unbal} = \frac{ E_{max} }{V_{avg}}$ </p>
Instantaneous power	P: total active power Q: total reactive power S: total apparent power P, Q and S are rms instantaneous values.
Power maximeter	Maximum value of the instantaneous time power (refreshed every 1 s) since Micrologic installation or last reset.
Demand power ⁽¹⁾	Mean of all instantaneous time power values over a given user-adjustable time interval (e.g. 10 min).
Instantaneous power factor PF	PF = P / S
Total energy	Ep: total active energy Eq: total reactive energy Es: total apparent energy

⁽¹⁾ For details on how demand is calculated, see "Calculating demand values" in the technical appendix page 52.

Micrologic E control units let you access information that can be used to analyse or avoid circuit breaker tripping, thereby increasing the overall availability of your installation. Available information includes the trip history and tripping pre-alarms.

Trip history

The trip history displays the list of the last 10 trips. For each trip, the following indications are recorded and displayed:

- the tripping cause: Ir, Isd, li, Ig or Auto-protection (Ap) trips
- the date and time of the trip (requires communication option) in order to set Date and Time.

List of trip causes:

- overloads (Ir)
- short-circuits (Isd or li)
- ground faults (Ig)
- auto-protection (Ap).

The trip history display is presented on page 28.

Pre-alarms

Definition

Micrologic E control units can be set to deliver pre-alarms via their optional M2C contacts (see page 38). These pre-alarms can be used to warn operators that the current is approaching a trip threshold. In this way, remedial measures (e.g. load-shedding, maintenance, etc.) can be taken before the circuit breaker trips, avoiding unnecessary shutdowns.

Two types of pre-alarms are available, depending on the control unit.

- Long-time protection pre-alarm: all Micrologic E control units can be set to deliver a pre-alarm via one of their two outputs when the current reaches 90 % of the long-time protection current setting Ir.
- Ground-fault protection pre-alarm: Micrologic 6.0 E control units can also be set to deliver a pre-alarm via one of their two outputs when the current reaches 90 % of the ground-fault protection pickup Ig. Both Ir and Ig pre-alarms can be implemented if neither of the two outputs are required for other functions.

See page 32 for general information on output settings (M2C contacts) or page 35 for an example of how to set an output to implement these or other functions.

Operation

The Ir and Ig pre-alarms are delivered via the non-latching outputs (M2C contacts) of Micrologic E control units.

- Pickup (pre-alarm activation): when the current exceeds the pickup threshold (equal to 90 % of the Ir current setting or Ig pickup), the output state changes from 0 to 1 after a time delay of 0.1 second.
- Dropout (pre-alarm deactivation): when the current falls below the dropout threshold (equal to 85 % of the Ir current setting or Ig pickup), the output state returns to 0 after a non-adjustable time delay of 0.1 second and the pre-alarm is automatically deactivated.

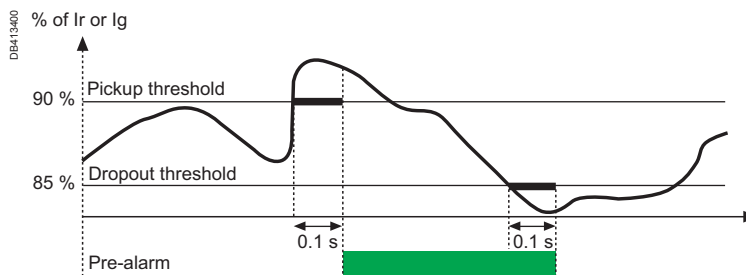

	Pickup (pre-alarm activation)		Dropout (pre-alarm deactivation)	
	Threshold	Time delay	Threshold	Time delay
Ir pre-alarm	90 % of Ir	0.1 s	85 % of Ir	0.1 s
Ig pre-alarm	90 % of Ig	0.1 s	85 % of Ig	0.1 s









Definitions

- Micrologic A has a single display mode: Tree Navigation mode.
- Micrologic E has two display modes: Tree Navigation and Quick View modes.

Tree Navigation mode

- Tree Navigation is a manual scroll mode using the  and  buttons on a Micrologic A or E control unit.
- All information can also be viewed on an optional FDM121 Front Display Module or on a PC using the communication option (see table page 38).
- Two navigation trees are provided for each Micrologic control unit:
 - a Display tree to view the main values and settings of the control unit
 - a Setting tree to modify the settings.

You can enter the Setting tree from any screen of the Display tree by pressing the  and  buttons simultaneously.

- Each tree is divided up into several branches (see opposite page). Use the  button to scroll through the different branches of a tree. When on the last branch, pressing the  button returns you to the instantaneous I1 current screen of the Display tree.
- Each branch provides access to values or settings that depend on the type of Micrologic control unit, for example:
 - measurements (instantaneous current, demand current, maximum instantaneous current, voltage, power, energy, etc.)
 - trip history
 - protection setting display
 - settings (for modification of communication, measurement or output parameters).
- Use the  button to scroll through the different screens of a given branch. Press the  button at any time to proceed to the next branch.

- All the screens of the Micrologic A navigation trees are detailed on page 24.
- All the screens of the Micrologic E navigation trees are detailed on page 25.

Quick View mode

- Micrologic E also offers a Quick View display mode.
- This mode can be used to let the display automatically scroll through up to 10 screens.
- An override function is available to allow manual scrolling.
- Quick View is the factory-set display mode for Micrologic E. You can easily switch between Quick View and Tree Navigation modes by briefly pressing the  button.
- You can modify the Quick View screens defined in the default configuration and the screen display time.

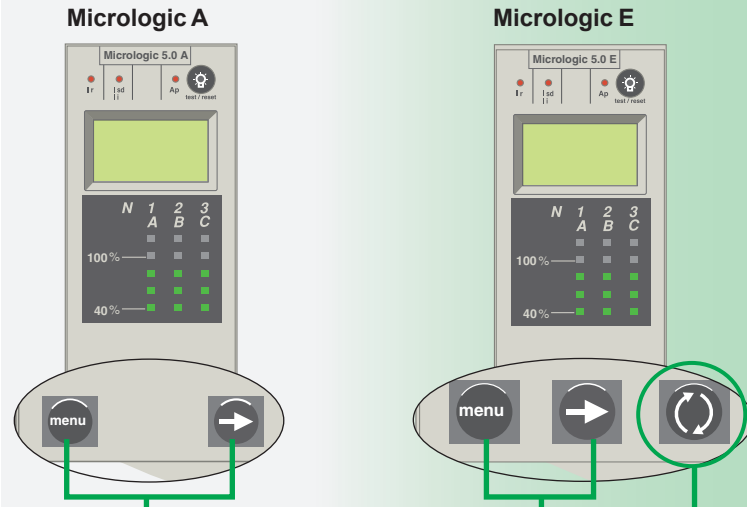

Micrologic A

Micrologic E

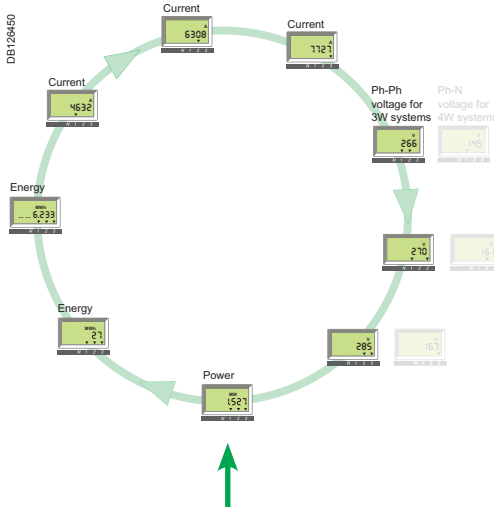

DE128450

Current: 6300, 1127

Energy: 6233, 27

Power: 1527, 285

Ph-Ph voltage for 3W systems: 255

Ph-N voltage for 4W systems: 16.1

Tree Navigation

Micrologic A display tree

Instantaneous current

menu [3.150] ... [32.7]

Max. of instantaneous current

menu [Max 3.150] ... [Max 32.7]

Micrologic E display tree

Instantaneous and demand current

menu [3.150] ... [7.706]

Max. of instantaneous current

menu [Max 3.150] ... [Max 32.7]

Voltage

menu [409] ... [690]

Power

menu [1527] ... [1527]

Active energy

menu [27] ... [7233]

Trip history

menu [15d 19] ... [01:03:11]

Protection setting display

menu [IR 1000] ... [II 1600]

Micrologic A setting tree

Communication settings

menu [Ad47] ... [En]

Micrologic E setting tree

Communication settings

menu [Pd = 23] ... [Mo = 4]

Measurement settings

menu [Min MW WIN 15] ... [() = 2.]

Output settings (with optional M2C contacts)

menu [Max 32.7] ... [β... Out=2]

Software version

menu [SW 1000]

Quick View

You can enter the Setting tree from any screen of the Display tree by pressing the and buttons simultaneously.

Quick View mode (Micrologic E) Presentation

Quick View allows the operator to quickly view the most important electrical measurements (currents, voltages, active power, energy) without having to touch the control unit keypad.

The screens automatically scroll in a circular manner so that the operator can view all the main electrical measurements one after another. The current bargraph and overload LED remain visible at all times in Quick View mode.

Quick View screen descriptions

Quick View can be used to display the screens defined in:

- the factory configuration
- a custom configuration.

Screens defined in the factory configuration

Micrologic E control units come with a factory Quick View configuration including the following 9 screens, scrolled in the indicated order:

1. Current of phase 1/A
2. Current of phase 2/B
3. Current of phase 3/C
4. Voltage: phase-to-neutral (V1N) or phase-to-phase (V12)
5. Voltage: phase-to-neutral (V2N) or phase-to-phase (V23)
6. Voltage: phase-to-neutral (V3N) or phase-to-phase (V31)
7. Total active power
8. Active energy: whole number part (up to 6 digits) in MWh
9. Active energy: last digit of whole number part plus 3 digits of decimal part

Each screen is displayed for 2 s before being replaced by the next in the list. This duration can be adjusted from 1 s to 9 s in 1 s steps (see "Measurement settings - Quick View display duration" on page 30).

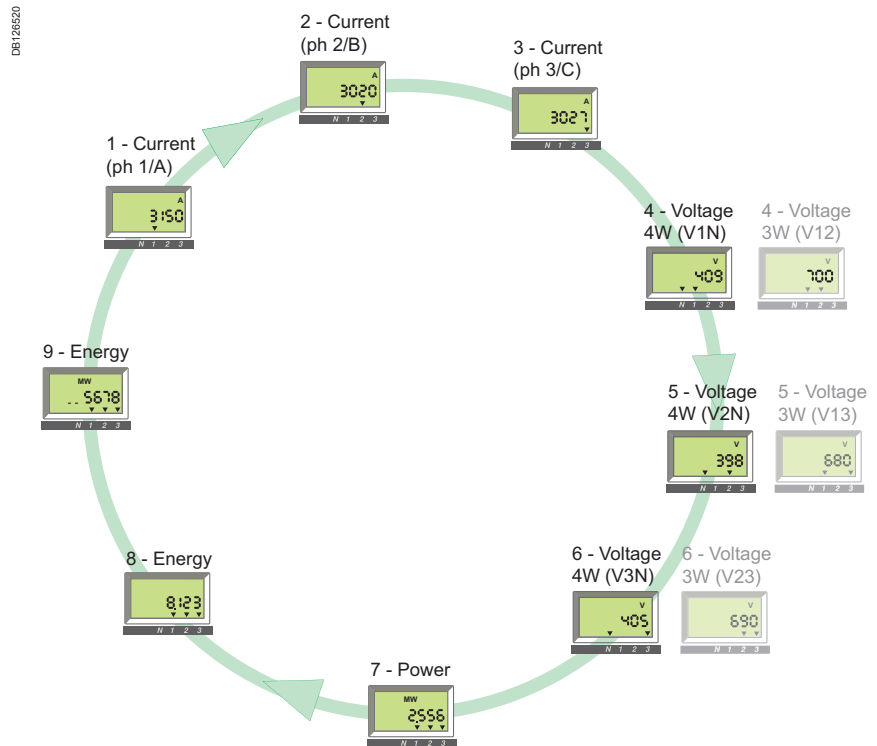

Activating / Deactivating Quick View

- When energised for the first time, Micrologic E automatically activates Quick View and scrolls through the factory-configured screens.
- Press the  button briefly (<1 s) to activate the classical tree navigation mode. Press again briefly (<1 s) to return to Quick View mode.
- In both Tree Navigation and Quick View modes, the first screen displayed is screen 1, but in tree navigation mode, finally the screen changes to display the instantaneous current of the most heavily loaded phase.

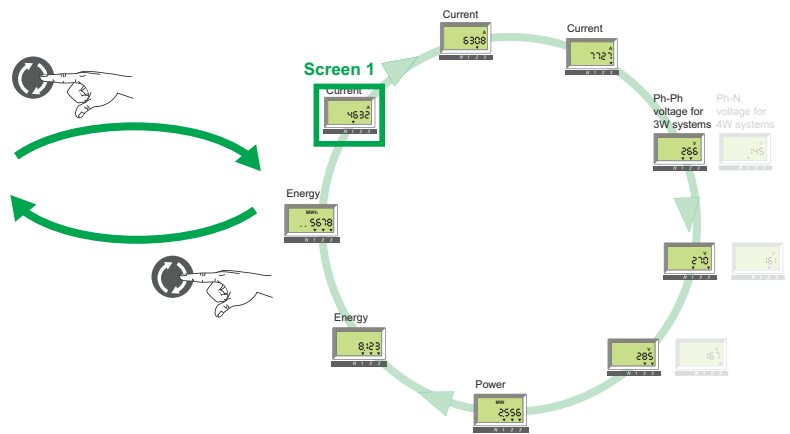
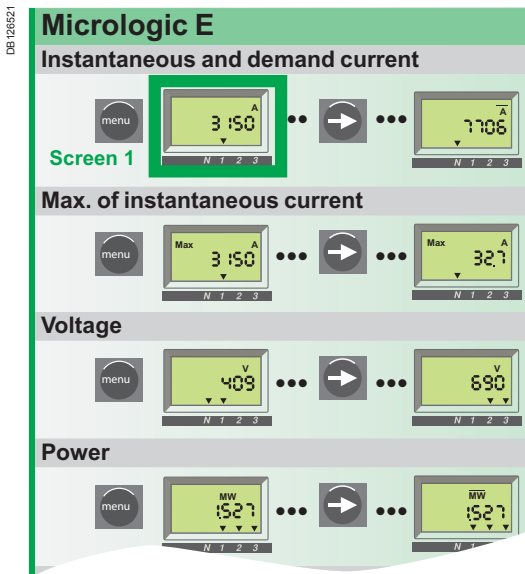

Manual control of Quick View scrolling

Automatic scrolling of Quick View screens can be stopped, for example to display a screen for more than 2 seconds in order note measurements.



Press briefly (< 1 s)

Stops scrolling and displays the present screen for 20 s if no other action is taken.

It is then possible to manually scroll through each Quick View screen one after the other.



Press briefly (< 1 s)

Displays the next screen for 20 s if no other action is taken.

Returning to automatic scrolling

After a period of 20 s with no action, automatic scrolling is automatically reactivated.

Events causing the interruption of automatic scrolling

Automatic scrolling of Quick View screens is also interrupted by the following events:



- tripping (interrupted until the trip is reset by pressing the  button)
- change in a protection setting
- battery test (while the test button is pressed).

Custom Quick View configuration

- The Quick View factory configuration includes the 9 screens presented on the page 20.
- It is possible to change some or all of the screens of the factory configuration.
- Quick View can scroll through up to 10 screens.
- If all Quick View screens are removed, pressing the  button briefly will have no effect. The display remains in Tree Navigation mode.

Removing a screen

To remove a screen from Quick View:



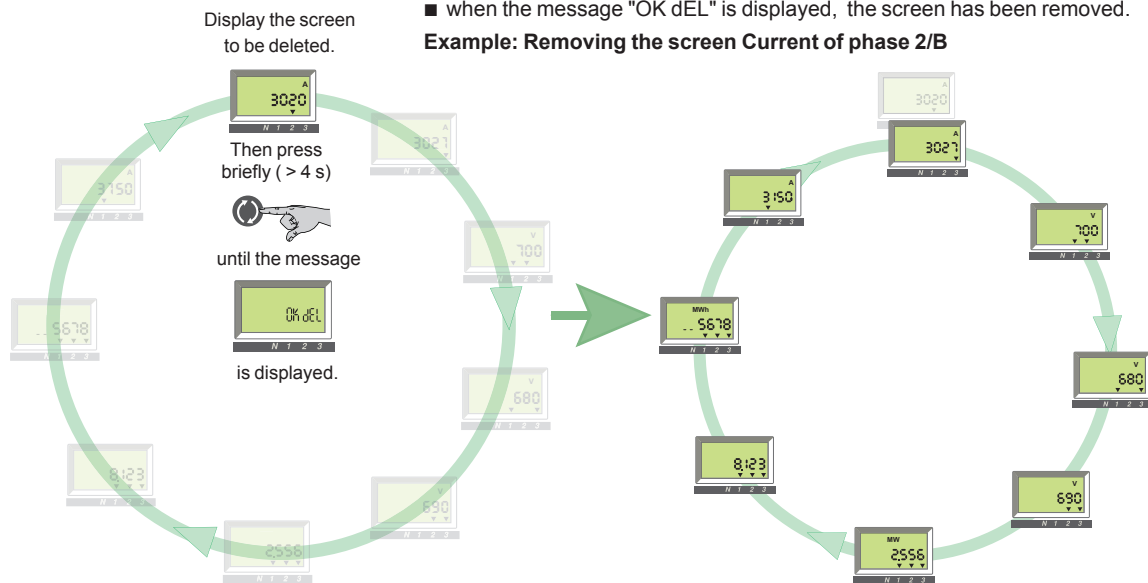

- make sure you are in manual control of the quick view mode, and if necessary, press the  button briefly (< 1 s) to activate automatic scrolling and then press the  button briefly (<1s) to activate the manual control of the quick view mode
- when the screen to be removed appears, press and hold the  button (> 4 s)
- when the message "OK dEL" is displayed, the screen has been removed.

Example: Removing the screen Current of phase 2/B



Adding a screen

To add a screen (selected from the navigation tree):

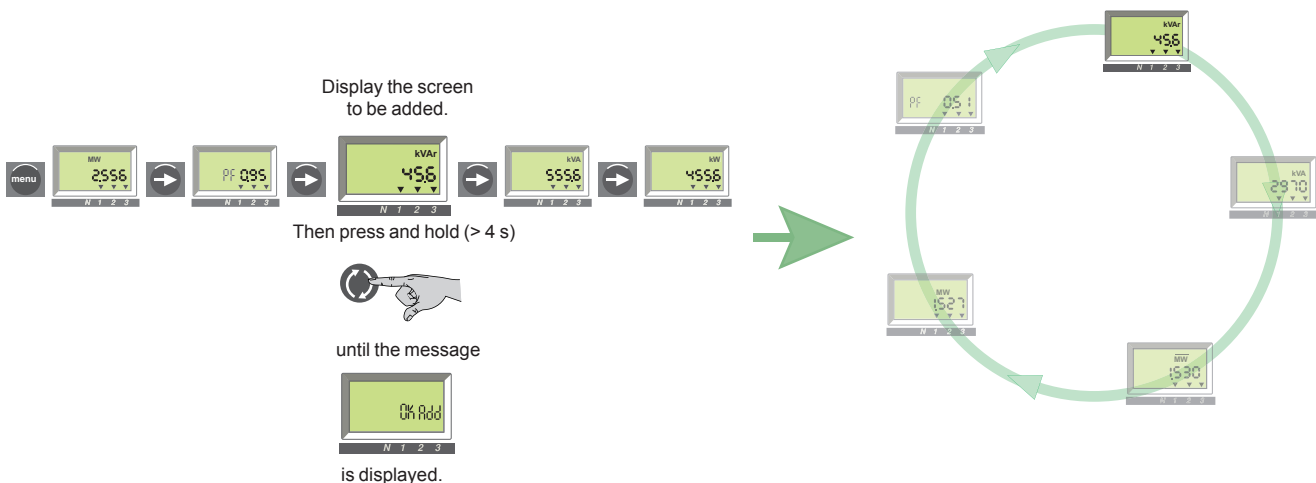

- access Tree Navigation mode by briefly pressing the  button (< 1 s)
- in this mode, display the screen you want to add using the  and  buttons, as described in "Tree Navigation" on page 23.
- when the selected screen is displayed, press and hold the  button (> 4 s)
- when the message "OK Add" is displayed, the screen has been added to the Quick View configuration. It will be placed in the last Quick View position.



- if you try to add a screen to an existing configuration that already has 10 screens, the message "QV full" will be displayed.

Tree Navigation mode Presentation

Tree Navigation

- The classical navigation trees presented in the "HMI introduction" on page 19 provide access to all the screens of Micrologic A or Micrologic E control units.
- The different screens are accessible using the  and  buttons and are organised in branches corresponding to a given type of information.

The following branches are available, in the indicated order, depending on the type of Micrologic control unit:

Branch (type of information)	Micrologic A	Micrologic E
Display tree		
Instantaneous current	■	
Instantaneous and demand current		■
Maximeters for instantaneous current	■	■
Voltage		■
Power (total of 3 phases)		■
Active energy (total of 3 phases)		■
Trip history (last 10)		■
Protection setting display	■	■
Setting tree		
Communication settings	■	■
Measurement settings		■
Output settings (with optional M2C contacts)		■
Software version		■

Navigating with the keypad buttons

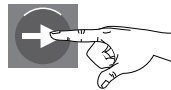

Press briefly
($< 1\text{ s}$)
(symbol: a white hand)

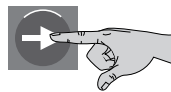

Press and hold
($> 4\text{ s}$)
(symbol: a grey hand)

Screen information

The positions of the downward arrows (one, two or three arrows) under the information displayed on the screen indicate the phases concerned, as shown for example in the screens below.

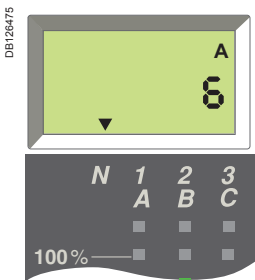

6 A current in the neutral (arrow above the N).

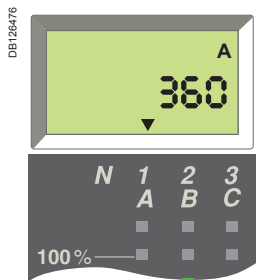

360 A current in phase 1/A (arrow above 1/A).

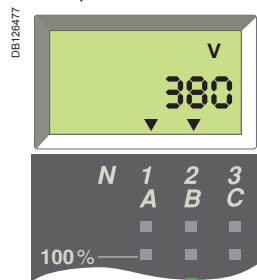

380 V phase-to-phase voltage between phases 1/A and 2/B (arrows above 1/A and 2/B).

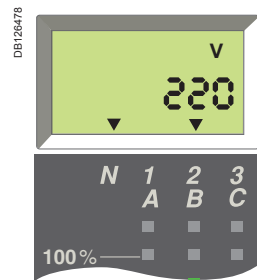

220V phase-to-neutral voltage between phase 2/B and neutral (arrows above N and 2/B).

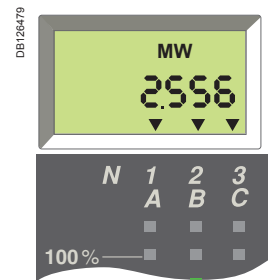

2.556 MW total active power of the 3 phases (arrows above the 3 phases).

If no particular action is taken, the system displays the instantaneous current of the most heavily loaded phase.

Default screen

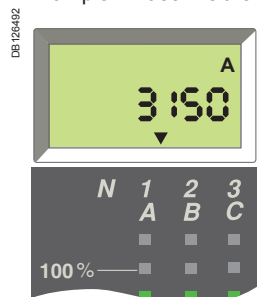

Example: Phase 1 is the most heavily loaded.



Tree Navigation mode

Micrologic A menu display

The figures below show all the screens of the 2 Micrologic A **navigation trees** with all details concerning screen content and navigation between the various branches and screens of the trees.

Display tree branches	Screens
Default display (instantaneous current of the most heavily loaded phase)	
Instantaneous currents	<p>I1 I2 I3 IN Ig (Micrologic 6.0 A) IΔn (Micrologic 7.0 A)</p> 
Instantaneous current maximeters To reset current maximeters, see page 27.	<p>I1 I2 I3 IN Ig (Micrologic 6.0 A) IΔn (Micrologic 7.0 A)</p> 
Protection setting display (See details on page 29)	
Setting tree branches	Screens
Communication settings (See details on page 30)	

Tree Navigation mode

Micrologic E menu display

The figures below show all the screens of the 2 Micrologic E **navigation trees** with all details concerning screen content and navigation between the various branches and screens of the trees.

Display tree branches	Screens
Default display (instantaneous current of the most heavily loaded phase)	
Instantaneous and demand currents	I1 I2 I3 IN Ig (Micrologic 6.0 E) I1 I2 I3 IN
Instantaneous current maximeters To reset current maximeters, see page 27.	I1 I2 I3 IN Ig (Micrologic 6.0 E)
Voltages (3-wire systems)	V12 V23 V31
Voltages (4-wire systems)	V1N V2N V3N V12 V23 V31
Power Active Power is displayed positively or negatively according to the parameter Power sign (see page 32).	P PF Q S Demand P
Active energy Ep is displayed in MWh on 2 screens, see details on page 26. To reset active energy, see page 27.	Ep (MWh) Ep (MWh)
Trip history (see details on page 28)	The trip history displays the list of the last ten trips.
Protection settings display (see details on page 29)	The protection settings displayed depend on the model of the Micrologic E control unit.
Setting tree branches	Screens
Communication settings (see details on page 32)	
Measurement settings (see details on page 32)	
Output settings (with optional M2C contacts) (see details on page 32)	
Software version	

Tree Navigation mode

Displaying total active energy (Micrologic E)

Energy

The total active energy (Ep) consumed since Micrologic energisation is displayed on 2 screens:

- the first screen displays the whole number part of total energy in MWh
- the second screen displays the decimal part of total energy in MWh.

Example: display of Ep = 26.233 MWh (26233 kWh)

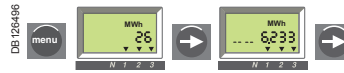

Display of whole number part of total energy in MWh (up to 6 digits)

Display of decimal part of total energy in MWh (up to 3 digits after the decimal preceded by the last digit of the whole number part)

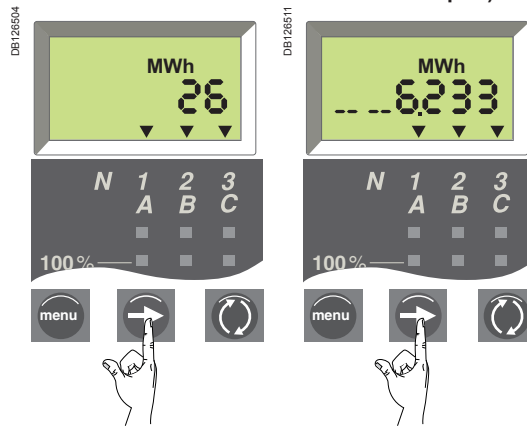

Press the "Arrow" button to go to screen for the decimal part.

Press the "Arrow" button to go to screen for the whole number part.

The total active energy (Ep) is calculated and displayed positively whatever the value of the parameter Power sign. The Maximum totale active energy displayed is 999 999 999 MWh. If the total active energy keeps increasing, the value displayed is 999 999 999 MWh.

Tree Navigation mode

Resetting current maximeters and total active energy

Resetting the maximum current values

Reset of the corresponding memory register.



Select the maximum current value to be reset (e.g. I2 max.)



Press the "Arrow" button as many times as required to access the I2 max. screen.

Reset



Press and hold the "Arrow" button down for 3 to 4 seconds. The old value changes to the present value (the new maximum).

Select another value of current to reset or return to the main menu

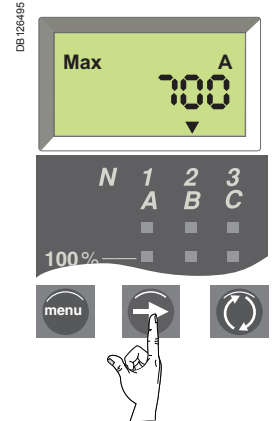

Press the "Arrow" button as many times as required to select another maximum value to reset or return to the main menu.

Resetting the total active energy (Micrologic E)



Select the active energy screen



Press the "Arrow" button as many times as required to access the total active energy screen (displaying the whole number part of the total active energy).

Reset



Press and hold the "Arrow" button down for 3 to 4 seconds. The old value changes to the new value (starting at 0) when releasing the button.

Return to the main menu



Press the "Menu" button to return to the main menu.

Tree Navigation mode

Displaying the trip history (Micrologic E)

Introduction

The trip history displays the list of the last 10 trips. For each trip, the following indications are recorded and displayed:

- the tripping cause: Ir, Isd, li, Ig or Auto-protection (Ap) trips
- the date and time of the trip (requires communication option in order to set date and time).

Example 1: Display for the first (most recent) trip of the five trips recorded in the trip history.



Ir: tripping cause.
 1.5: symbol indicating trip history display
 1: trip number (1 being the most recent)
 5: total number of trips recorded.

Example 2: Display for the ninth trip of the ten trips recorded in the trip history.

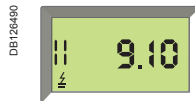

li: tripping cause.
 9.10: symbol indicating trip history display
 9: trip number (1 being the most recent)
 10: total number of trips recorded.

List of trip screens for the various causes

Cause	Comment	Screen display
Ir trip	Long-time protection	
Isd trip	Short-time protection	
li ⁽¹⁾ trip	Instantaneous protection	
Ig trip	Ground-fault protection	
Ap trip	Auto-protection	

(1) Instantaneous protection trips (li) are indicated on the trip history screen in the same way as short-time protection trips (Isd). Both are caused by short-circuits.

Trip date and time

For each trip history screen, Micrologic E will display the date and time of the trip. Every time the 24 VDC control voltage is energised, date and time restart at January first 2000. Therefore, it is strongly recommended to set date and time periodically (at least once an hour).

The setting of the Micrologic E date and time requires the communication option and can be set in one of 2 ways:

- via the front display module FDM121
- or using a supervision software (RCU, ION-Enterprise, etc.).















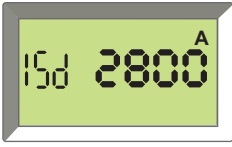

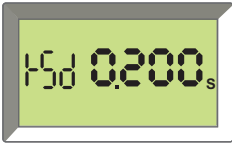

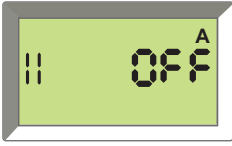
2 screens (date and time) will be displayed successively when the button is pressed:

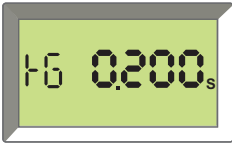

In this example, date is January third 2011 and time is 12 h 34 min and 56 s.

Tree Navigation mode

Displaying the protection settings

	Micrologic control unit 2.0A 5.0A 6.0A 7.0A 2.0E 5.0E 6.0E		
DE119483 Long-time current setting Ir	■ ■ ■ ■	 Select the "Settings" menu. The Ir value is displayed first.	
Long-time tripping delay tr	■ ■ ■ ■	 Press the "arrow" button to go on to the tr value.	
Short-time pick-up Isd	■ ■ ■ ■	 Press the "arrow" button to go on to the short-time Isd value.	
Short-time tripping delay tsd	■ ■ ■ ■	 Press the "arrow" button to go on to the tsd value.	
Instantaneous pick-up Ii	■ ■ ■ ■	 the instantaneous Ii value.	
Ground-fault pick-up Ig	■ ■ ■ ■	 Press the "arrow" button to go on to the Ig value. or	
Earth-leakage pick-up IΔn	■ ■ ■ ■	 the IΔn value.	
Ground-fault tripping delay tg	■ ■ ■ ■	 Press the "arrow" button to go on to the tg value. Or	
Earth-leakage tripping delay Δt	■ ■ ■ ■	 the Δt value.	
		 Press the "arrow" button to return to the beginning of the menu.	



Tree Navigation mode

Micrologic A set-up

Set-up parameters

When the communication option is used with Micrologic A, the communication parameters must be set. The following table lists these parameters and indicates their possible values.

The procedure to change the settings is described on the next page.

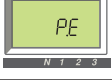
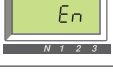

Parameters	Definition	Format (X = digit)	Default value (units)	Default value screen	Possible values
Communication settings ⁽¹⁾ for Micrologic A with communication option (Modbus network)					
Modbus address	Unique Modbus address of Micrologic A on the Modbus network to which it is connected.	XX	47		1 to 47
Baud rate	Number of kbits/s (kbauds) exchanged on the Modbus network. It must be set to the same value for all devices on the network.	XX.X	19.2 (kb)		9.6 / 19.2
Parity	Used for error checking based on the number of bits in the transmitted data group.	E or n	E		E (Even) n (None)
Language	Work language for the screens	En or Fr	En		En (English) Fr (French)

⁽¹⁾ When the communication option is used, the communication parameters must be set. The communication module should be set up only when installed. Modification of a parameter on a system already in operation may lead to communication faults.

Tree Navigation mode

Micrologic A set-up

Setting procedure

- Briefly press the  button to scroll through the possible settings for a given parameter.
- Press the  button somewhat longer to save the setting and go on to the next parameter.
- After selecting the language, press and hold the  button to return to the "Metering" menu.

Metering menu

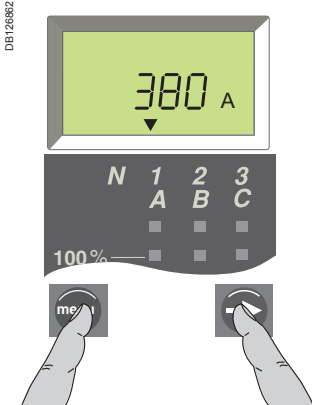

You are in the "Metering" Menu. Simultaneously press the two buttons to access the parameter settings for the communication option.

Modbus address

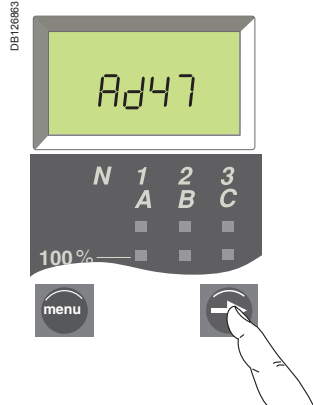

Select the desired Modbus address

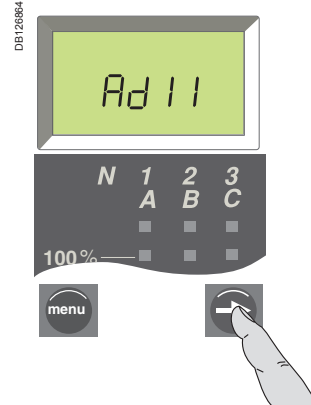

Then press and hold to save the setting and go on to the next parameter.

Metering menu

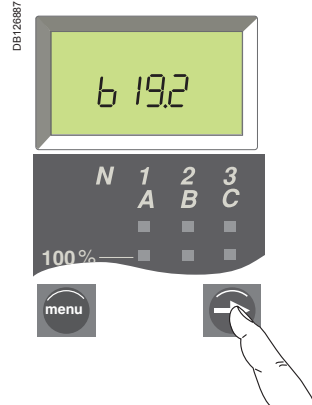

Select the desired baud rate.

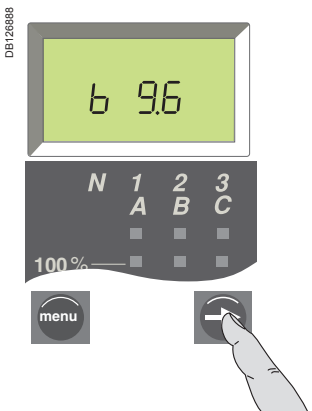

Then press and hold to save the setting and go on to the next parameter.

Parity

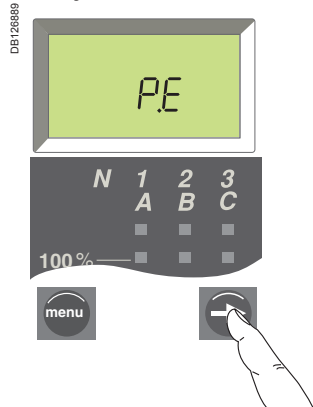

Select the desired parity setting.

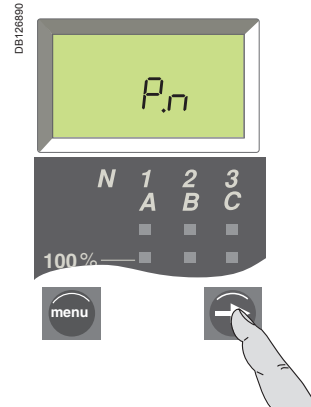

Then press and hold to save the setting and go on to the next parameter.

Language

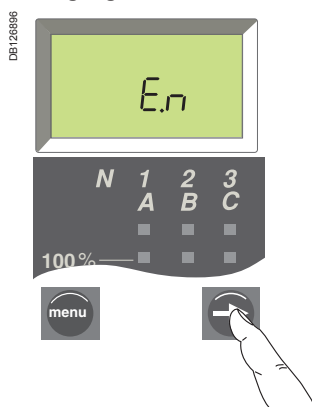

Select the desired language.

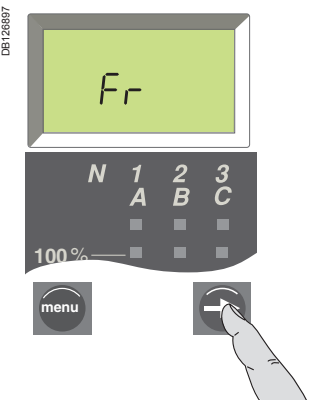

Press and hold to return to the "Metering" Menu.

Tree Navigation mode

Micrologic E set-up

Set-up parameters











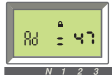

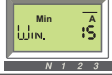
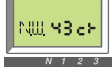
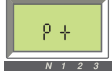
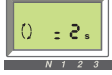
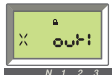

Micrologic E has three types of set-up parameters:

- communication settings
- measurement settings
- M2c output settings.

The corresponding parameters (Address, Baud rate, etc.) have default values that can or must be changed according to the needs of the installation or users.

The following table lists these parameters and indicates their possible values. The procedure to change the settings is described on the next page.

The parameters are displayed in the order indicated in the table below.

Parameters	Definition	Format (X = digit)	Default value (units)	Default screen ⁽²⁾	Possible values
Communication settings ⁽¹⁾ for Micrologic E with communication option (Modbus network)					
Modbus address	Address of Micrologic E on the Modbus network to which it is connected.	XX	47		1 to 47
Baud rate	Number of kbits exchanged per second (kbauds on the Modbus network).	XX.X	19.2 (kb)		4.8 9.6 19.2
Parity	Used for error checking based on the number of bits in the transmitted data group.	E or n	E		E (Even) n (None)
Modbus connection	Type of Modbus connection: 4-wire (4) or 2-wire + ULP (ULP)	4 or ULP	4		4 ULP
Measurement settings					
Interval (window) for demand power calculation	Period of time over which the demand power is calculated.	XX	15 (minutes)		5 to 60 (in 1 minute steps)
Interval (window) for demand current calculation	Period of time over which the demand current is calculated.	XX	15 (minutes)		5 to 60 (in 1 minute steps)
Type of network (3-wire or 4-wire) and number of circuit breaker poles (CTs).	<ul style="list-style-type: none"> ■ Setting 43 = 4-wire (3ph+N) and 3-pole CB (3 CTs) ⁽³⁾ ■ Setting 44 = 4-wire (3ph+N) and 4-pole CB (4 CTs) or 3-pole CB (3 CTs) + external CT ■ Setting 33 = 3-wire (3ph) and 3-pole CB (3 CTs) ⁽⁴⁾ 	XX	43		43 44 33
Power sign	By default, the Micrologic E considers power flowing into the circuit breaker via the top terminals to loads connected to the bottom terminals as positive (top fed).	+ or --	+		+ --
Quick View display duration	Duration of display of each screen in Quick View mode	()	2 (s)		1 to 9
Output settings for Micrologic E with optional M2C contacts					
Output	Two outputs are available via the 2 optional M2C contacts: <ul style="list-style-type: none"> ■ Out 1 and Out 2. Setting possibilities are the same for both.				Out 1 Out 2
Event assigned to the output	Various events can be assigned to each output: <ul style="list-style-type: none"> ■ 3 trip events: <ul style="list-style-type: none"> <input type="checkbox"/> tripping caused by Ir <input type="checkbox"/> tripping caused by Isd or Ii <input type="checkbox"/> tripping caused by Ig (Micrologic 6.0 E) ■ 2 pre-alarm events: <ul style="list-style-type: none"> <input type="checkbox"/> Ir pre-alarm <input type="checkbox"/> Ig pre-alarm (Micrologic 6.0 E) 				Not assigned
					Ir trip
					Isd (includes Ii) trip
					Ig trip (6.0 E)
					Ir pre-alarm
					Ig pre-alarm (6.0 E)
Output state	The output state (normally "0") can be controlled in three ways: <ul style="list-style-type: none"> ■ forced to 1 (for testing) ■ forced to 0 (for testing) ■ changed from 0 to 1 (without latching) on occurrence of the assigned event (normal mode) 				Forced to 1
					Forced to 0
					Normal mode (no latching)

⁽¹⁾ When the communication option is used, the communication parameters must be set. The communication module should be set up only when installed. Modification of a parameter on a system already in operation may lead to communication faults. ⁽²⁾ Note that all the default screens include a closed padlock icon. This means the value is protected. You must open the padlock to modify the settings and close the padlock after your modification in order to protect the new value. The procedure is described on the next page. ⁽³⁾ Important: for 3-pole circuit breakers used on 4-wire systems (3ph + N), terminal VN on the Micrologic control unit must always be connected to the neutral. If this is not done, the phase-to-neutral voltage measurements can be erroneous. ⁽⁴⁾ Important: for 3-pole circuit breakers used on 3-wire systems (neutral not distributed), always set this value to 33 (see below) to avoid indications of a meaningless phase-to-neutral voltage.

Tree Navigation mode

Micrologic E set-up

General procedure to set Micrologic E parameters

The parameters are divided into three branches on the navigation tree:

- communication settings
- measurement settings
- output settings.

The following describes the general procedure to modify the settings. The next two pages give examples for the Modbus address and output settings.

Accessing the first screen of the communication settings branch

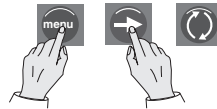

Simultaneously press and hold (four seconds) the "menu" and "arrow" buttons to access the first communication settings screen. The present value is displayed. A closed padlock icon indicates that the setting is locked.

Unlocking and accessing the setting to be changed (flashing)



Press the "Quick View" button to open the padlock. The setting to be changed (or the first digit) will flash, indicating that it is ready to be modified.

Selecting the new setting



Press the "Quick View" button to select the new setting. The possible settings are scrolled in a loop. Each press increments to the next setting or choices in the loop.

Confirming and locking the new setting



Press the "arrow" button to confirm the new setting. It stops flashing and a closed padlock is displayed.

For a two-digit setting, this operation sets the first digit and the second digit flashes to indicate it is ready to be modified. Proceed as above to change it, then press the "menu" button to validate the new two-digit setting. It stops flashing, and a closed padlock is displayed.



Press the "arrow" button to go to the screen for the next parameter in the communication settings branch. To go to the next branch (measurement settings), press the "menu" button.

Note: Within a given branch, the various parameters are organised in a loop. You must scroll through all the parameters of the branch using the "arrow" button to return to the same parameter. To proceed to the next set-up branch (or exit the last branch), press the "menu" button.

Example 1: Setting the Modbus address

The Modbus address is a two-digit number identifying the Micrologic E in a Modbus network.

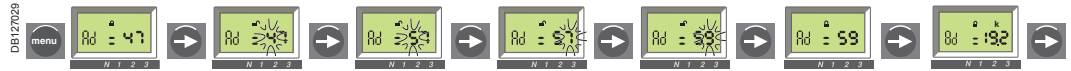

Access the existing Modbus address

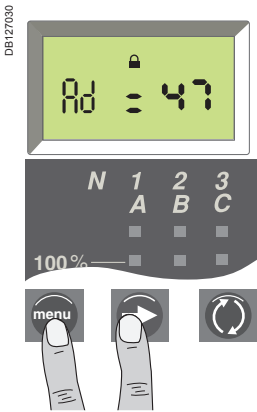

Simultaneously press the and the buttons for four seconds to access the address setting screen. The existing address is displayed (default address 47 or XX). A closed padlock icon indicates that the value is locked.

Unlock and access the first digit (flashing)

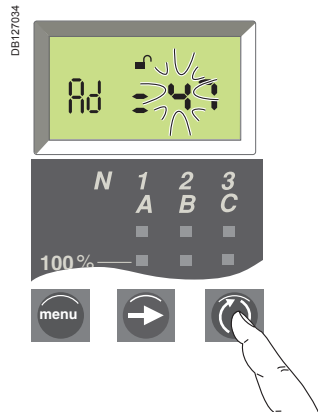

Press the button to open the padlock and display the first digit (e.g. 4). It will flash, indicating it is ready to be modified.

Modify the first digit

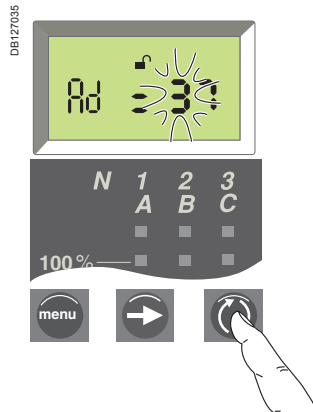

Press the button repeatedly until the new value for the first digit is displayed. You can scroll through all possible values in a loop⁽¹⁾.

Confirm the first digit and access the second digit (flashing)

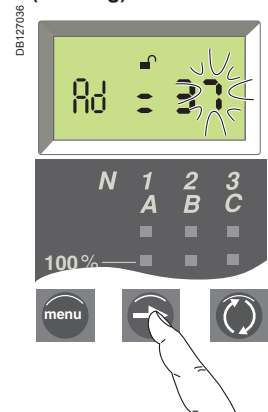

Briefly press the button to display the second digit. The digit will stop flashing and the second digit will start flashing, indicating it is ready to be modified.

Modify the second digit

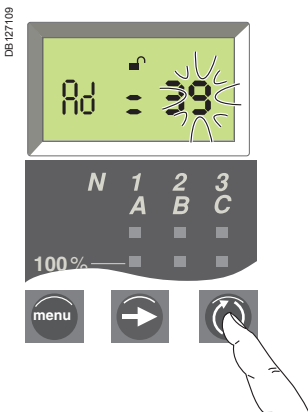

Press on the button repeatedly until the new value for the second digit is displayed. You can scroll through all possible values in a loop, as for the first digit.

Confirm and lock the new setting⁽¹⁾



Press the button again to confirm and lock the new setting. The second digit stops flashing and a closed padlock is displayed.

Display next setting screen



Briefly press the button again to go on to the next parameter.

⁽¹⁾ The maximum address is 47. If you try to set a higher address, Micrologic will set the address to the maximum address of 47.

Example 2 : Setting Output 1 (for Micrologic E with optional M2C contacts)

The state of output 1 can be associated with the occurrence of a given trip event.



Access the Output 1 setting screen

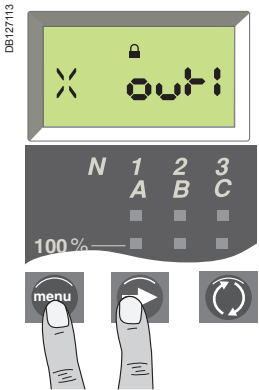

Simultaneously press the and the buttons for four seconds to access the Modbus address screen. Then press the button to access the output setting screen. The existing output setting is displayed (default setting is indicating that no trip event has been assigned to the output). A closed padlock icon indicates that the setting is locked.

Unlock and access the setting

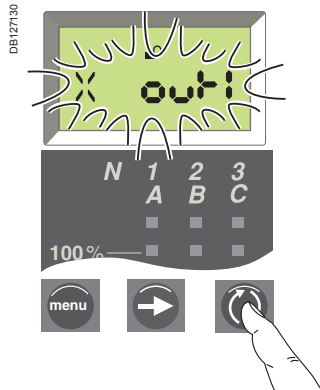

Press the button to open the padlock. The existing setting will flash, indicating it is ready to be modified.

Modify the trip event assigned to Output 1

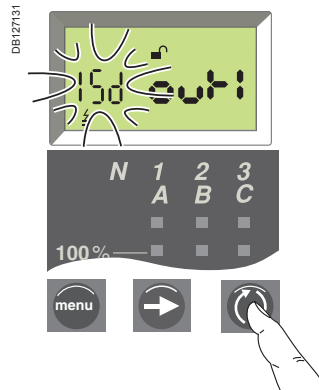

Press the button repeatedly until the desired trip event is displayed. You can scroll through all possible events in a loop (see list of possible events page 32).

Confirm and lock the trip event setting

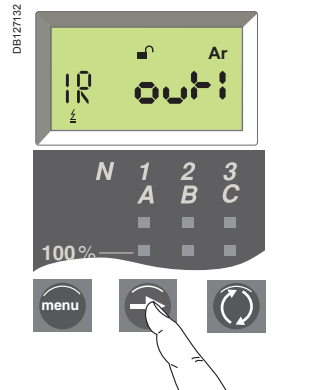

Press the button to confirm and lock the new setting. The setting stops flashing and a closed padlock is displayed.

Modify the output state control mode

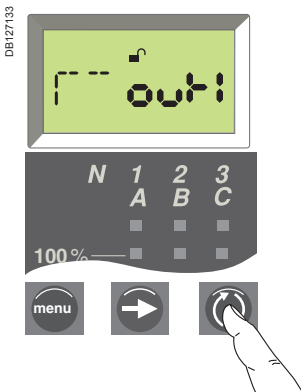

Press the button repeatedly until the desired output state control mode is displayed (see page 32). In normal mode, the output goes from "0" to "1" (without latching) on occurrence of the assigned event.

Confirm and lock the Output 1 state setting

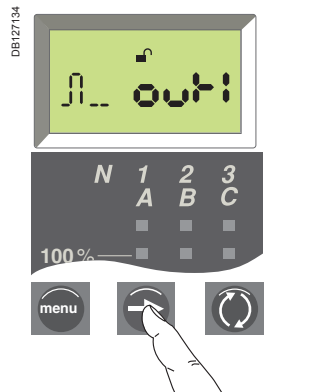

Press on the button to confirm and lock the new setting. The setting stops flashing and a closed padlock is displayed.

Display next setting screen

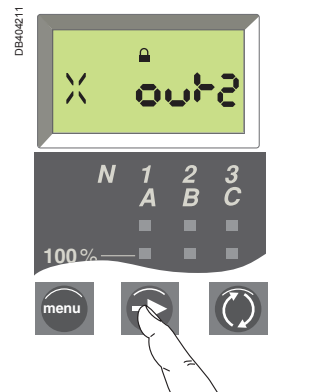

Press the button again to go to the screen for the next parameter.

Resetting the fault indications Checking and changing the battery

The procedure for closing the circuit breaker following a fault trip is presented in the circuit breaker user manual.

Resetting the fault indications

- Determine why the circuit breaker tripped. The fault indication is maintained until it is reset on the control unit.
- Press the fault-trip reset button.

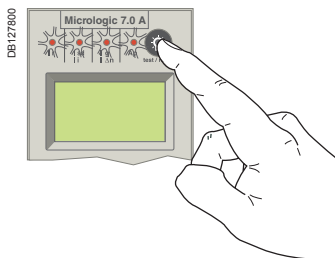

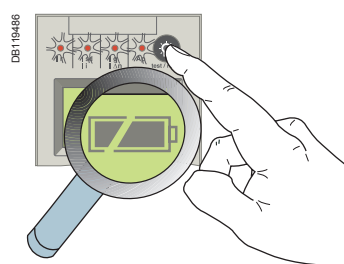

Checking the battery

Micrologic A



Press the battery-test button (same as the fault-trip reset button) to display the battery status.

-  Battery charged
-  Battery half charged
-  Change the battery

Micrologic E

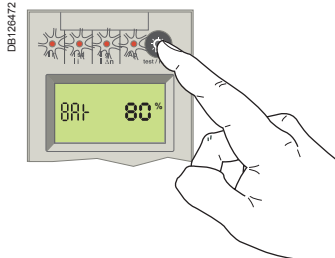

Press the battery-test button (same as the fault-trip reset button) to display the battery status.

Battery charge level displayed in percent (100 %, 80 %, 60 %, 40 %, 20 % or 0 %).

If no information is displayed:

- either no battery is installed in the control unit;
 - or an auxiliary power supply is required.
- See "Micrologic digital display" in the technical appendix.

If the battery needs to be changed, order a new battery with the Schneider Electric catalogue number 33593.

- Lithium battery.
- 1.2 AA, 3.6 V, 850 mA/h.
- SAFT LS3 SONNENSCHN TEL-S.
- Service life ten years.

Changing the battery

1. Remove the battery cover.
2. Remove the battery.

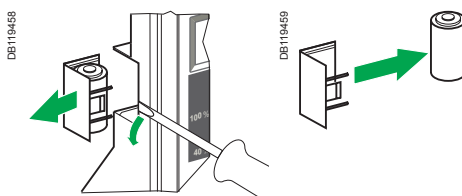

3. Insert a new battery. Make sure the + and - poles match the indications.
4. Put the cover back in place. Press the battery-test button to check the new battery.

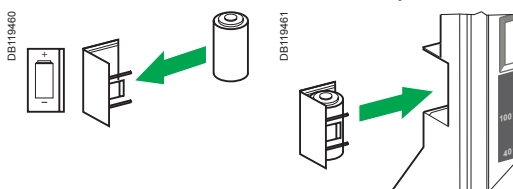

Testing the ground-fault and earth-leakage functions

- Charge and close the circuit breaker.
- Using a screwdriver, press the test button for ground-fault and earth-leakage protection. The circuit breaker should open.

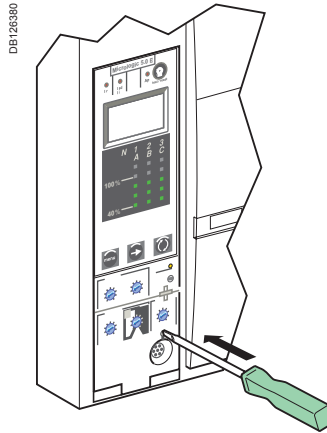

Important:

If the circuit breaker does not open, contact the Schneider Electric after-sales support department.

Optional M2C contacts

Micrologic E programmable outputs

Important:
The M2C contacts require an auxiliary power supply.

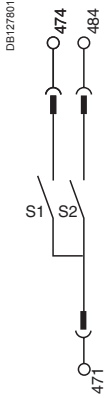

Wiring diagram for M2C contacts.

Possible functions

The Micrologic E control unit can be equipped with up to two M2C contacts (S1 and S2) that can be used to activate:

- alarms to signal and identify tripping caused by long-time, short-time, instantaneous or ground-fault protection
- pre-alarms to warn of imminent tripping by ground-fault (Micrologic 6.0 E) or long-time protection.

Contact operation

The contacts can be set to change the state of Micrologic E outputs Out1 and/or Out2 from 0 to 1 when certain events occur:

- trip events, i.e. when the control unit is tripped by:
 - long-time protection I_r
 - short-time instantaneous protection I_{sd} or I_i
 - ground-fault protection I_g (Micrologic 6.0 E only)
- pre-alarm events, i.e. when the current reaches 90 % of the following trip thresholds:
 - long-time protection setting I_r
 - ground-fault protection pickup I_g (Micrologic 6.0 E only).

For details on how to assign different events to the contacts, see "Output settings" on page 32 or the example on page 35.

Latching settings

When the output state setting is in "Normal mode" (see page 32), the contacts are non-latching, i.e. the contact remains activated (state = 1) only as long as the event that caused the change of state remains present.

Two other output state settings are available (forced to 1 or 0) for testing needs (see page 32).

Time delays

- Pickup: when the current exceeds the selected tripping or pre-alarm pickup threshold, the output state changes from 0 to 1 after a fixed time delay of 0.1 second.
- Dropout: when the circuit is opened by the circuit breaker or when the current falls below the pre-alarm dropout threshold (see page 17), the output state returns to 0 after a non-adjustable time delay of 0.1 second.

Contact operating diagrams

Contact operating diagram for long-time, short-time, instantaneous and ground-fault protection trip alarms

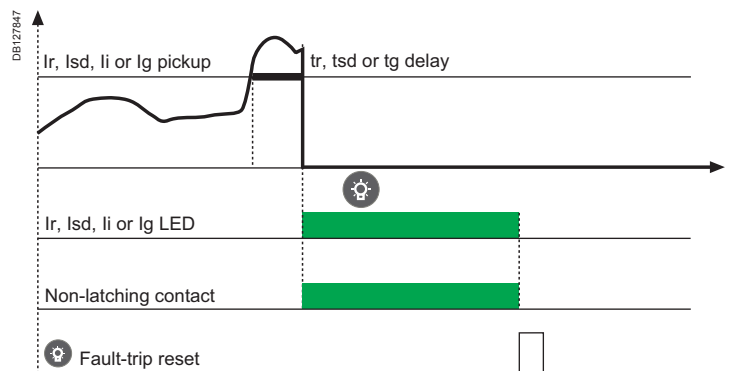

Contact operating diagram for I_r and I_g pre-alarms

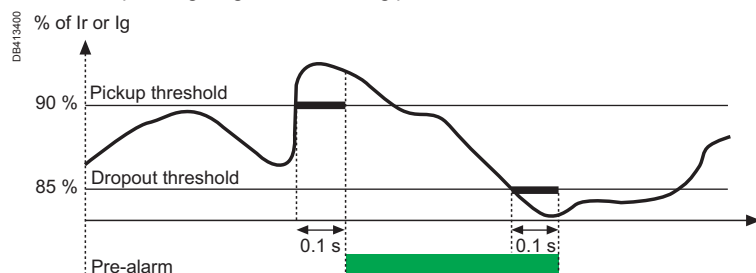

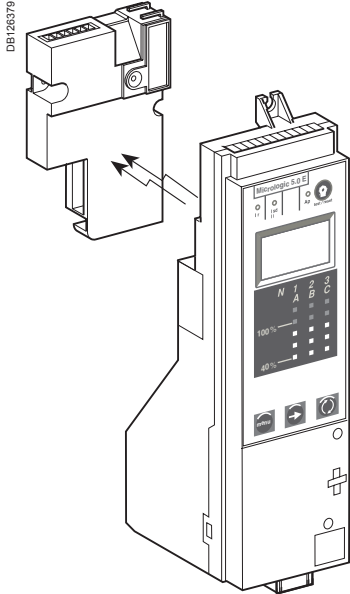

The communication option consists of an independent module that fits behind the Micrologic control unit.

Communication option

The communication option uses a Modbus communication protocol to remotely access the following information and functions available in the Micrologic control unit:

- status indications
- controls
- measurements
- operating assistance.

It consists of an independent communication module installed behind the Micrologic control unit. This module receives and transmits information via the communication network. An infra-red link transmits data between the control unit and the communication module.

Modbus communication

Modbus bus

The Modbus RS 485 (RTU protocol) system is an open bus on which communicating Modbus devices (Masterpact with Modbus COM, Power Meter, Sepam, VigiloHM, etc.) are installed. All types of PLCs and computers may be connected to the bus.

Modbus communication parameters

For a Masterpact or Compact NS circuit breaker equipped with a Micrologic control unit, the Modbus address, baud rate and parity are set using the keypad on the control unit.

The Modbus communication system is divided into four managers that secure data exchange with the supervision system and the circuit-breaker actuators.

The manager addresses are automatically derived from the circuit-breaker address @xx entered via the Micrologic control unit (the default address is 47).

Modbus addresses

@xx	Circuit-breaker manager	(1 to 47)
@xx + 50	Chassis manager	(51 to 97)
@xx + 200	Measurement managers	(201 to 247)
@xx + 100	Protection manager	(101 to 147)

Number of devices

The maximum number of devices that may be connected to the Modbus bus depends on the type of device (Masterpact with Modbus COM, Power Meter, Sepam, VigiloHM, etc.), the baud rate (19200 bauds is recommended), the volume of data exchanged and the desired response time. The RS 485 physical layer offers up to 32 connection points on the bus (1 master, 31 slaves).

Each protection devices uses 1 or 2 connection points:

- a fixed device requires only one connection point (communication module on the device)
- A drawout or withdrawable device uses two connection points (communication modules on the device and on the chassis).

The number of devices must never exceed 31 fixed devices or 15 drawout/withdrawable devices.

Bus length

The maximum recommended length for the Modbus bus is 1200 m.

Bus power source

A 24 V DC power supply is required (less than 20 % ripple, insulation class II).

Data and functions available via the communication option

Masterpact and Compact NS circuit breakers equipped with Micrologic control units and the Communication option can be integrated in a Modbus communication environment. In this case the following information and functions are available remotely.

	Micrologic	
	A	E
Status indications		
ON/OFF	■	■
Spring charged CH	■	■
Ready to close PF	■	■
Fault-trip SDE	■	■
Connected/disconnected/test position (via CE/CD/CT contacts of optional chassis communication module)	■	■
Controls		
MX1 opening release	■	■
XF closing release	■	■
Measurements		
Current		
Instantaneous currents I_1 , I_2 , I_3 , I_N , I_g , $I_{\Delta N}$	■	■
Current maximeters: I_{1max} , I_{2max} , I_{3max} , I_{Nmax} , I_{gmax} , $I_{\Delta Nmax}$	■	■
Average current I_{avg}		■
Current unbalance I_{unbal}		■
Demand current		
Demand currents \bar{I}_1 , \bar{I}_2 , \bar{I}_3 , \bar{I}_N		■
Demand current maximeters (peak demands) $\bar{I}_1 \text{ max}$, $\bar{I}_2 \text{ max}$, $\bar{I}_3 \text{ max}$, $\bar{I}_N \text{ max}$		■
Voltage		
Phase-to-phase voltages V_{12} , V_{23} , V_{31} (3-wire and 4-wire systems)		■
Phase-to-neutral voltages V_{1N} , V_{2N} , V_{3N} (4-wire systems) ⁽¹⁾		■
Average voltage V_{avg}		■
Voltage unbalance V_{unbal}		■
Power		
Instantaneous power P, Q, S		■
Demand power P, S		■
Demand power maximeters P_{max}		■
Instantaneous power factor PF		■
Energy		
Total Energy E_p		■
Total Energy E_q , E_s		■
Operating assistance		
Setting of the control-unit date and time		■
Functional unit (IMU) name	■	■
Power sign		■
Interval for the demand-current calculation window		■
Interval for the demand power calculation window		■
Battery-charge indication	■	■
Trip histories		■
Operation counter	■	■
Assignment and setup of programmable contacts (M2c)		■
Protection		
Circuit-breaker rated current	■	■
Type of neutral protection	■	■
Long-time I^2t protection settings	■	■
Short-time protection settings	■	■
Instantaneous-protection settings	■	■
Ground-fault protection settings	■ 6.0 A	■ 6.0 E
Earth-leakage protection settings	■ 7.0 A	

⁽¹⁾ Important: for 3-pole circuit breakers used on 4-wire systems (3ph + N), terminal VN on the Micrologic control unit must always be connected to the neutral. If this is not done, the phase-to-neutral voltage measurements can be erroneous.

The ULP System

Definition

ULP (Universal Logic Plug) is a connection system that can be used to build an electrical distribution solution integrating metering, communication and operating assistance functions for Masterpact and Compact NS circuit breakers.

PB106672-176

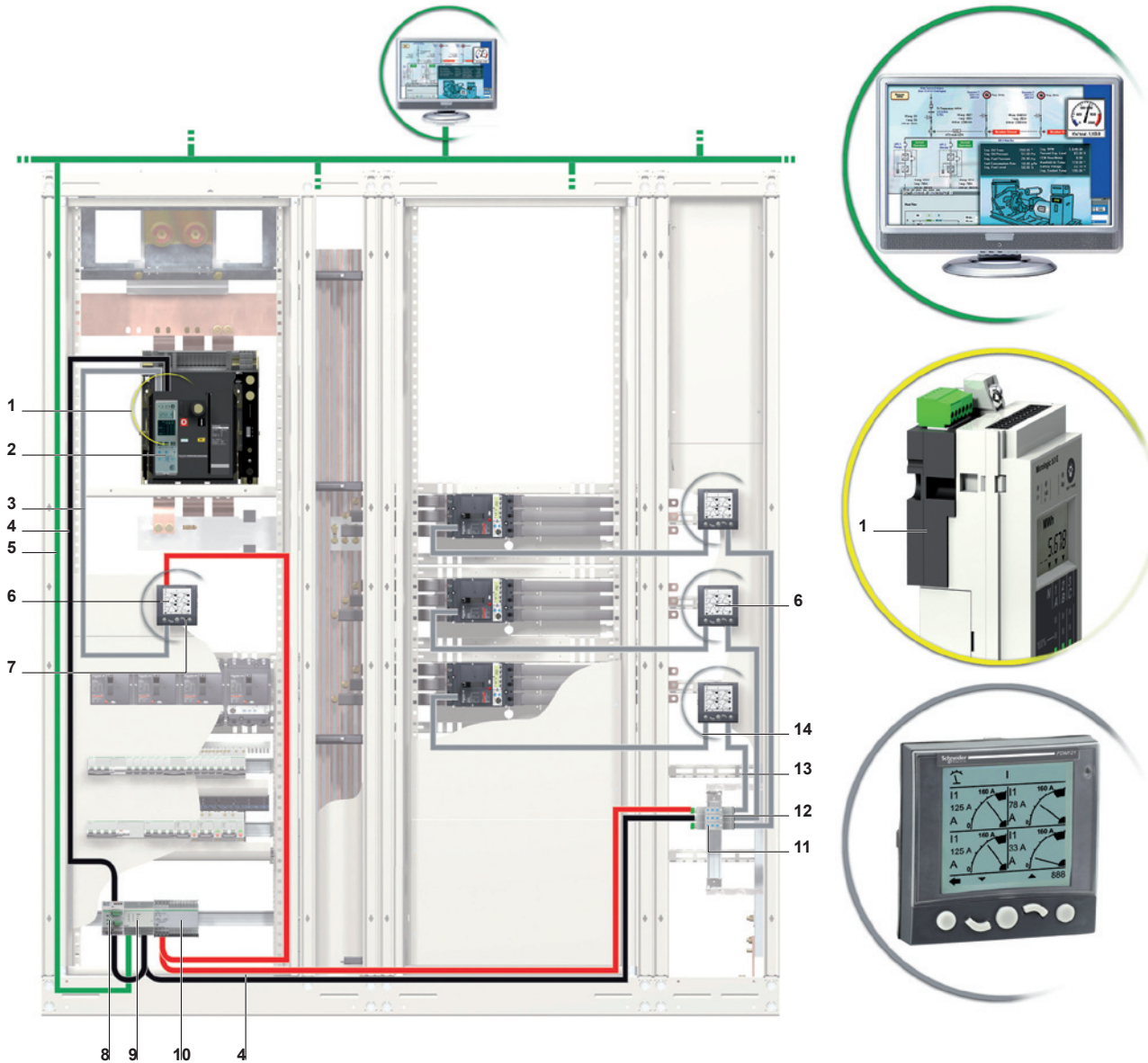

- 1 BCM ULP: Breaker Communication Module with ULP port
- 2 Micrologic control unit
- 3 Breaker ULP cord

0.35 m	LV434195
1.3 m	LV434196
3 m	LV434197
- 4 Modbus cable
- 5 Ethernet cable
- 6 FDM121: Front Display Module TRV00121
- 7 ULP line terminators TRV00880
- 8 CCM: Chassis Communication Module 33852
- 9 EGX100: Ethernet gateway
- 10 External 24 V DC power supply
- 11 Modbus interface TRV00210
- 12 Stacking accessory TRV00217

- 13 ULP cable

0.3 m	TRV00803
0.6 m	TRV00806
1 m	TRV00810
2 m	TRV00820
3 m	TRV00830
5 m	TRV00850

- 14 NSX cord

0.35 m	LV434200
1.3 m	LV434201
3 m	LV434202

The ULP system can be used to enhance the Masterpact and Compact NS circuit breaker functions by:

- local display of measurements and operating assistance data on the switchboard with the FDM121 front display module (firmware version \geq V2.1.0)
- setup and maintenance functions with the maintenance module and RSU software.

With the ULP system, Masterpact and Compact NS circuit breakers become metering and supervision tools that can be used to improve energy efficiency by:

- optimising energy consumption by zone or by application, taking load peaks and priority zones into account
- managing electrical equipment better.

For more information on the ULP system and the FDM121 display module, refer to the ULP system user manual.

Intelligent Functional Unit

A functional unit is a mechanical and electrical assembly containing one or more products that perform a given function in a switchboard (e.g. incoming protection, motor control). Functional units are modular and are easy to install in the switchboard.

Built around each Masterpact and Compact NS circuit breaker, the functional unit consists of:

- a dedicated plate for installing the Masterpact or Compact NS circuit breaker
- an escutcheon in front to prevent direct access to live parts
- prefabricated connections to the busbars
- on-site connection and auxiliary wiring accessories.

The ULP system can be used to enhance the functional unit by adding an FDM121 front display module to display all measurements and operating assistance data supplied by Micrologic control units.

With the ULP system, metering functions add intelligence to the functional unit.

PB104819

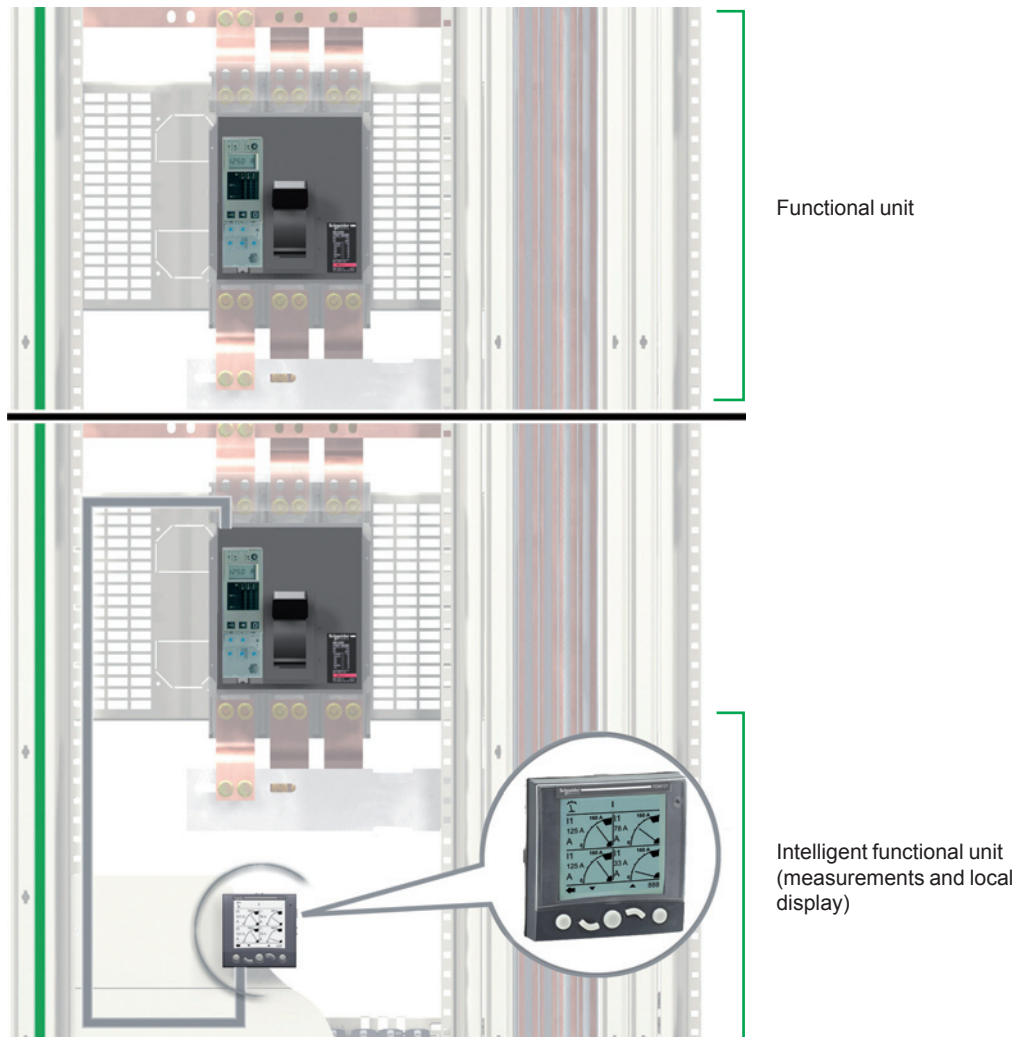

Functional unit

Intelligent functional unit (measurements and local display)

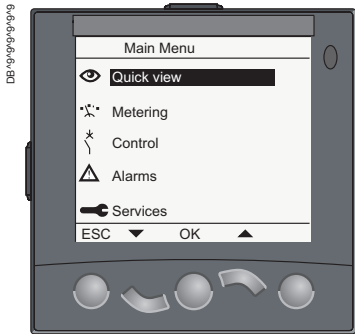

Main menu

Presentation

The **Main** menu offers 5 sub-menus containing the information required for monitoring and using the ULP system intelligent functional units. The content of the sub-menus has been adapted to Masterpact and Compact NS circuit breakers.

The 5 sub-menus accessible from the **Main** menu are described in the following table.

Menu	Description
Quick view	Quick View menu The Quick View menu provides quick access to information that is essential for operation.
Metering	Metering menu The Metering menu displays data made available by the Micrologic control unit: <ul style="list-style-type: none"> ■ current, voltage, power, energy measurements ■ minimum and maximum measurement values.
Control	Control menu The Control menu can be used to control a circuit breaker equipped with a motorised communicating remote operating mechanism. The available controls are: <ul style="list-style-type: none"> ■ circuit breaker opening ■ circuit breaker closing.
Alarms	Alarms menu The Alarms menu displays the trip history of the last 10 trips detected by the Micrologic control unit since the last power up of the FDM121 display module.
Services	Services menu The Services menu contains all the FDM121 display module set-up functions and the operating assistance information: <ul style="list-style-type: none"> ■ reset (peak demand values, energy meters) ■ set-up (display module) ■ maintenance (operation counters, load profile, etc.) ■ product version (identification of the intelligent functional unit modules) ■ language.

For more information on the FDM121 display module menus, refer to the ULP system user manual.

Navigation

Navigation within the Main menu is as follows:

- the ▲ and ▼ keys are used to select one of the 5 sub-menus
- the OK key is used to confirm the selection
- the ESC key has no effect.

Quick View menu

Presentation

The **Quick View** menu presents information that is essential for operating the device connected to the FDM121 front display module, divided into a number of screens. The number of available screens and their content depend on the device connected to the FDM121 front display module. For example, with Compact NS circuit breakers, this depends on:

- the type of Micrologic control unit (A, E, P or H)
- the metering system (3 ph 4-wire, 3 ph 3-wire 3CT, 3 ph 4-wire 4CT).

The screen number and total number of screens are indicated in the top right-hand corner of the display.

Navigation

Navigation within the **Quick View** menu is as follows:

- the ▲ and ▼ keys are used to go from one screen to another.
- the ESC key is used to return to the main menu.
- the key is used to modify the display mode.

Examples of Quick View menu screens

The table below shows screens 1 to 7 of the **Quick View** menu for a Compact NS 4-pole circuit breaker equipped with a Micrologic E control unit:

Screen	Description
	<p>Screen 1 in the Quick View menu displays:</p> <ul style="list-style-type: none"> the name of the functional unit (Aircon FDR on the screen example opposite). <p>The name of the functional unit defined with RSU can be up to 45 characters long, but only the first 14 characters are visible on the FDM121 front display module.</p> <ul style="list-style-type: none"> the Open/Closed/Trip status ("Open" on the screen example opposite) of the Compact NS circuit breaker the long time protection Ir current setting the current of the most heavily loaded phase (I2 = 217 A in the screen example opposite)
	<p>Screen 2 in the Quick View menu displays the currents:</p> <ul style="list-style-type: none"> Phase 1 current I1 Phase 2 current I2 Phase 3 current I3 Neutral current IN
	<p>Screen 3 in the Quick View menu displays the phase-to-phase voltages:</p> <ul style="list-style-type: none"> Phase 1 to phase 2 voltage V12 Phase 2 to phase 3 voltage V23 Phase 3 to phase 1 voltage V31
	<p>Screen 4 in the Quick View menu displays the phase to neutral voltages:</p> <ul style="list-style-type: none"> Phase 1 to neutral voltage V1N Phase 2 to neutral voltage V2N Phase 3 to neutral voltage V3N
	<p>Screen 5 in the Quick View menu displays the power values:</p> <ul style="list-style-type: none"> Active power Ptot in kW Reactive power Qtot in kVAr Apparent power Stot in kVA
	<p>Screen 6 in the Quick View menu displays the energy values:</p> <ul style="list-style-type: none"> Active energy Ep in kWh Reactive energy Eq in kVArh Apparent energy Es in kVAh
	<p>Screen 7 in the Quick View menu displays:</p> <ul style="list-style-type: none"> the power factor PF

Intelligent Functional Unit (IMU) name

For efficient use of the electrical equipment, the RSU software can be used to assign a name to the IMU that reflects the function of the latter.
The procedure for displaying the IMU name is as follows:

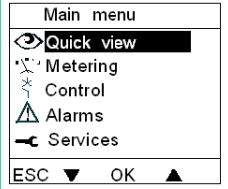
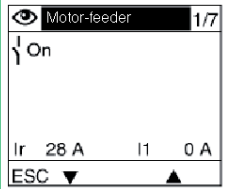
Step	Action	Display
1	Select the Quick View sub-menu in the main menu using the ▲ and ▼ keys. Press the OK key to confirm selection of the Quick View menu.	 <p>Main menu</p> <ul style="list-style-type: none"> Quick view Metering Control Alarms Services <p>ESC ▼ OK ▲</p>
2	Screen 1 in the Quick View menu displays the IMU name: Motor-feeder. The IMU name assigned using RSU software can consist of 45 characters maximum, but only the first 14 characters are visible on the FDM121 front display module.	 <p>Motor-feeder 1/7</p> <p>On</p> <p>Ir 28 A I1 0 A</p> <p>ESC ▼ ▲</p>

Tripping curves

Long-time and instantaneous protection (Micrologic 2.0 A/E)

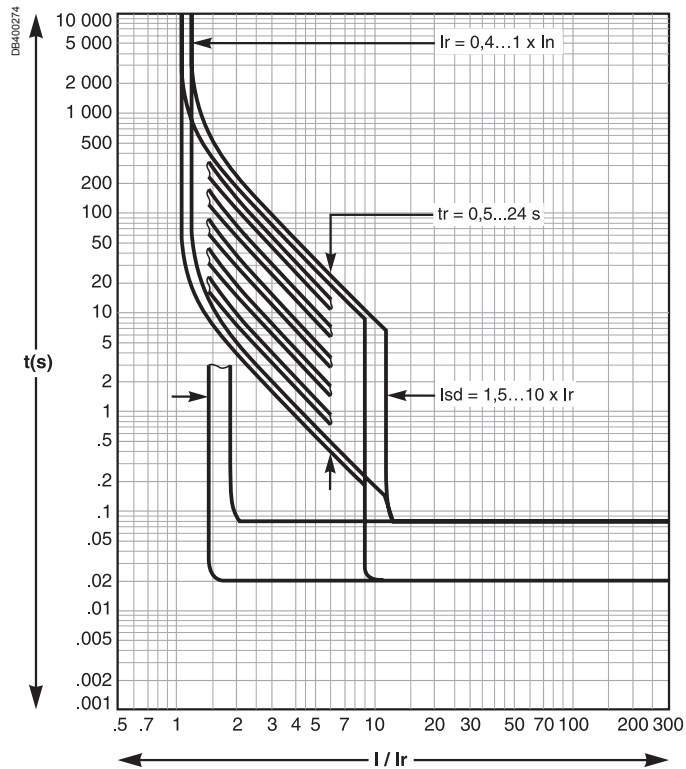

Long-time, short-time and instantaneous protection (Micrologic 5.0 A/E, 6.0 A/E and 7.0 A)

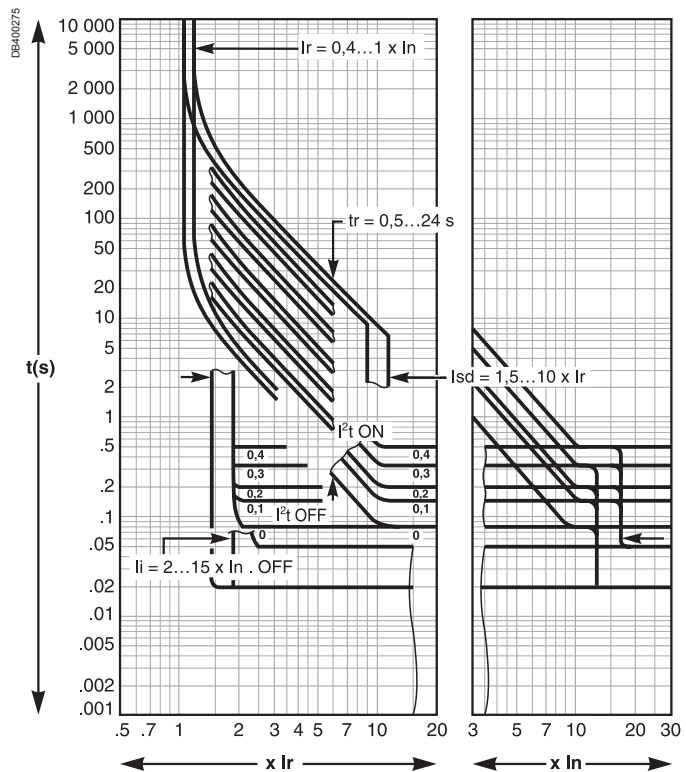

Ground-fault protection (Micrologic 6.0 A/E)

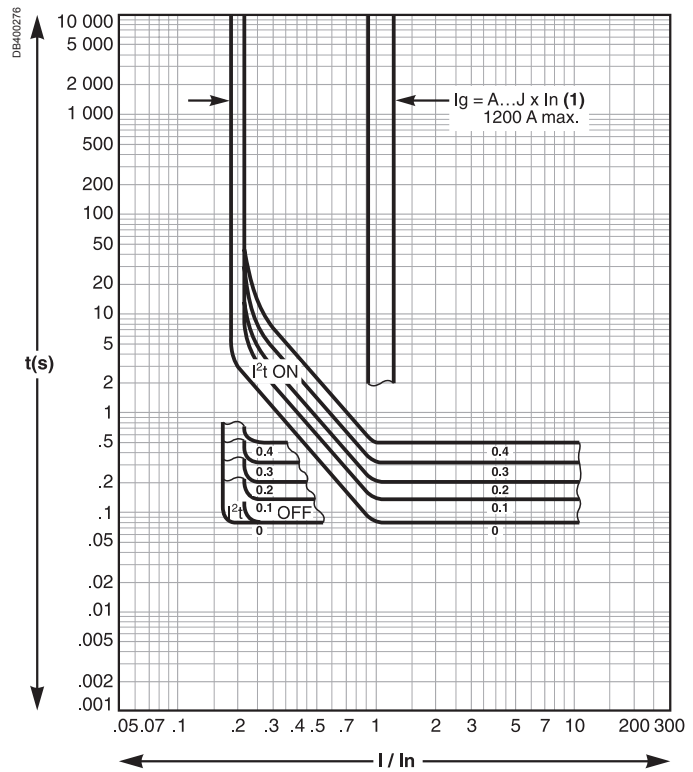

Changing the long-time rating plug

Select the long-time rating plug

A number of setting ranges for the long-time current setting are available on Micrologic A/E control units by changing the long-time rating plug. The available long-time rating plugs are listed below.

Part number	Setting range for the I_r value	
33542	Standard	0.4 to 1 x I_r
33543	Low setting	0.4 to 0.8 x I_r
33544	High setting	0.8 to 1 x I_r
33545	Without long-time protection $I_r = I_n$ for the I_{sd} setting	

Important

Following any modifications to the long-time rating plug, all control-unit protection parameters must be checked.

Change the long-time rating plug

Proceed in the following manner.

1. Open the circuit breaker.
2. Open the protective cover of the control unit.
3. Completely remove the long-time rating plug screw.

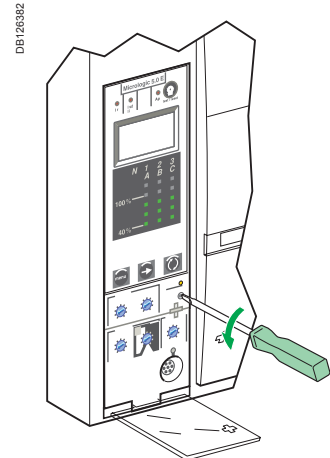
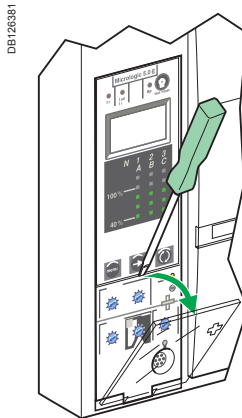

4. Snap out the rating plug.

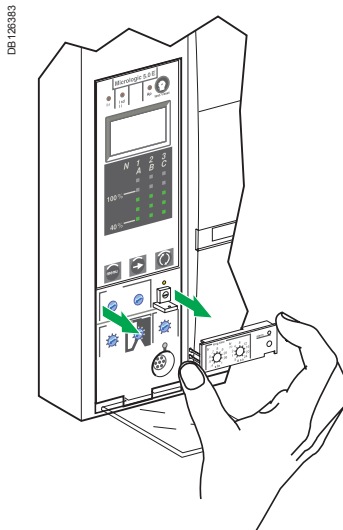

5. Clip in the new rating plug.
6. Refit the screw for the long-time rating plug.
7. Check and/or modify the control-unit settings.

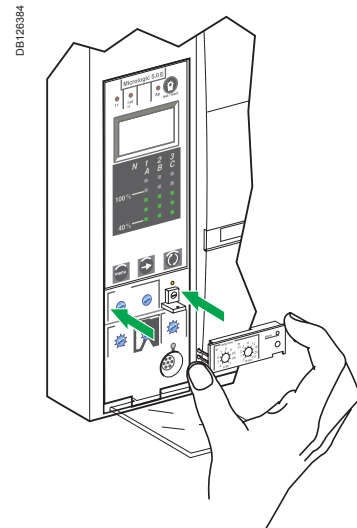

Important

If no long-time rating plug is installed, the control unit continues to operate under the following downgraded conditions:

- the long-time current setting I_r is 0.4
- the long-time tripping delay t_r corresponds to the value indicated by the adjustment dial
- the earth-leakage protection function is disabled.

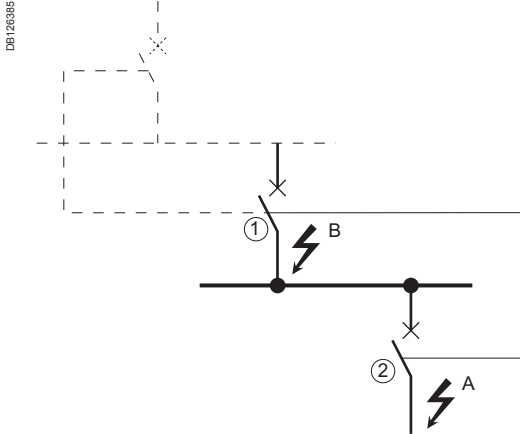

Operating principle

- A fault occurs at point A.
Downstream device no. 2 clears the fault and sends a signal to upstream device no. 1, which maintains the short-time tripping delay t_{sd} or the ground-fault tripping delay t_g to which it is set.
- A fault occurs at point B.
Upstream device no. 1 detects the fault. In the absence of a signal from a downstream device, the set time delay is not taken into account and the device trips according to the zero setting. If it is connected to a device further upstream, it sends a signal to that device, which delays tripping according to its t_{sd} or t_g setting.

Note: On device no. 1, the t_{sd} and t_g tripping delays must not be set to zero because this would make discrimination impossible.

Connections between control units

A logic signal (0 or 5 volts) can be used for zone selective interlocking between the upstream and downstream circuit breakers equipped with:

- Micrologic 5.0 A, 6.0 A, 7.0 A
- Micrologic 5.0 E, 6.0 E
- Micrologic 5.0 P, 6.0 P, 7.0 P
- Micrologic 5.0 H, 6.0 H, 7.0 H.

An interface is available for connection to previous generations of trip units.

Important

If the protection function is not used on circuit breakers equipped for ZSI protection, a jumper must be installed to short terminals Z3, Z4 and Z5.
If the jumper is not installed, the short-time and ground-fault tripping delays are set to zero, whatever the position of the adjustment dial.

Wiring

- Maximum impedance: $2.7 \Omega / 300 \text{ m}$
- Capacity of connectors: $0.4 \text{ to } 2.5 \text{ mm}^2$
- Wires: single or multicore
- Maximum length: 3000 m
- Limits to device interconnection:
 - the common ZSI - OUT (Z1) and the output ZSI - OUT (Z2) can be connected to a maximum of 10 upstream devices;
 - a maximum of 100 downstream devices may be connected to the common ZSI - IN (Z3) and to an input ZSI - IN CR (Z4) or GF (Z5).

Terminals Z1 to Z5 correspond to the identical indications on the circuit-breaker terminal blocks.

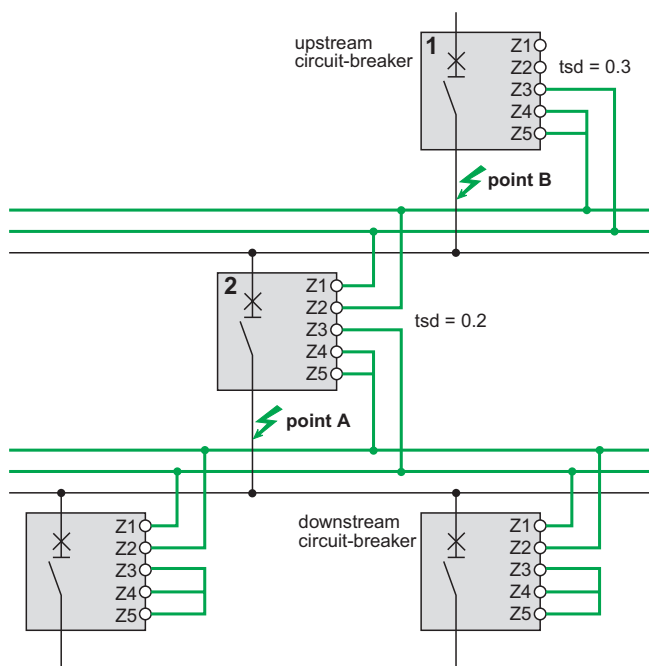

Test

The portable test kit may be used to check the wiring and operation of zone selective interlocking between a number of circuit breakers.

For information on connecting an external power supply, see the electrical diagrams in the circuit-breaker catalogue.



External power supply.

- The display operates without an external power supply. The digital display goes off if the current drops below $0.2 \times I_n$ (I_n = rated current). An optional 24 V DC external power supply may be used to maintain the display of currents even when the current drops below $0.2 \times I_n$.

- Display back-lighting is disabled in the following situations:

- current less than $1 \times I_n$ on one phase;
- current less than $0.4 \times I_n$ on two phases;
- current less than $0.2 \times I_n$ on three phases.

- The maximeter does not operate for currents under $0.2 \times I_n$.

- The display back-lighting and the maximeter may be maintained, whatever the current, by adding a 24 V DC external power supply. Even if an external power supply is installed, the long-time, short-time, instantaneous and earth protection functions will not use it.

External power supply characteristics

- Input voltage:
 - 110/130, 200/240, 380/415 V AC (+10 % -15 %)
 - 24/30, 48/60, 100/125 V DC (+20 % -20 %).
- Output voltage: 24 V DC ± 5 %, 1 A.
- Ripple < 1 %.
- Dielectric withstand : 3.5 kV rms between input/output, for 1 minute.
- Overvoltage category: as per IEC 60947-1 cat. 4.

Thermal memory

The thermal memory is the means to take into account temperature rise and cooling caused by changes in the flow of current in the conductors.

These changes may be caused by:

- repetitive motor starting
- loads fluctuating near the long-time protection settings
- repeated circuit-breaker closing on a fault.

Control units with a thermal memory record the temperature rise caused by each overload, even those that are very short. This information stored in the thermal memory reduces the tripping time.

Micrologic control units and thermal memory

All Micrologic control units are equipped as standard with a thermal memory.

- For all protection functions, prior to tripping, the temperature-rise and cooling time constants are equal and depend on the t_r tripping delay:
 - if the tripping delay is short, the time constant is low
 - if the tripping delay is long, the time constant is high.
- For long-time protection, following tripping, the cooling curve is simulated by the control unit. Closing of the circuit breaker prior to the end of the time constant (approximately 15 minutes) reduces the tripping time indicated in the tripping curves.

Short-time protection and intermittent faults

For the short-time protection function, intermittent currents that do not provoke tripping are stored in the Micrologic memory.

This information is equivalent to the long-time thermal memory and reduces the tripping delay for the short-time protection.

Following a trip, the short-time t_{sd} tripping delay is reduced to the value of the minimum setting for 20 seconds.

Ground-fault protection and intermittent faults

The ground-fault protection implements the same intermittent fault function as the short-time protection.

Calculating demand values (Micrologic E)

The Micrologic E trip unit calculates and displays:

- the demand values of phase and neutral currents,
- the demand value of the total active power.

The maximum (peak) demand current and power values are stored in the memory. All demand values are updated once every minute.

Definition

The demand value of a quantity is its average value over a given period of time. In electrical power systems, it is used especially for the current and power. The demand value should not be confused with the instantaneous value or the average (or mean) value, which often refers to the average (or mean) of the instantaneous values of the 3 phases.

Calculation interval

The time interval (or window) over which the average is calculated can be of 3 types:

- fixed window
- sliding window.

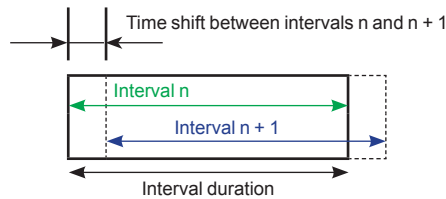
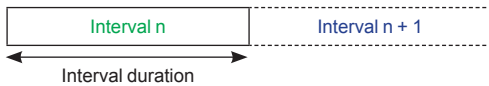

Fixed window

At the end of a fixed metering window:

- the demand value over the window is calculated and updated
- the new demand value is initialised over a new window, **starting from the end of the last window.**

Sliding window

At the end of a sliding window:

- the demand value over the window is calculated and updated
- the new demand value is initialised over a new window, **starting from a given time after the start of the last window** (always less than the duration of the window).

The sliding window method is used by Micrologic E control units.

- The duration of the sliding window can be set separately for current and power demand from 5 to 60 minutes in 1 minute steps (see Measurement settings on page 32). The default setting is 15 minutes.
- The time shift between intervals is equal to 1 minute.

Calculation method

Quadratic demand (thermal image)

The quadratic demand calculation model represents the conductor heat rise (thermal image).

The heat rise created by the current $I(t)$ over the time interval T is identical to that created by a constant current I_{th} over the same interval. This current I_{th} represents the thermal effect of the current $I(t)$ over the interval T .

Calculation of the demand value according to the thermal model must be always be performed on a sliding window.

Note: The thermal demand value is similar to an rms value.

Micrologic E control units use the quadratic model to calculate both demand current and demand power.

Peak demand values

The Micrologic E trip unit calculates:

- the maximum (peak) demand values of phase and neutral currents since the last reset
- the maximum (peak) demand values of total active power since the last reset.

The peak demand values can be accessed and/or reset in the following ways:

- peak demand current: via the Micrologic control unit (see page 25) or the Communication option (see page 40)
- peak demand power: via the Communication option (see page 39).

Presentation

RSU (Remote Setting Utility) software can be used on a PC to carry out all the functions normally available via the HMI using the keypad on the Micrologic control unit.

The various functions are available via three tabs:

- **Basic prot.** can be used to prepare, check and save all the basic protection settings of the selected Micrologic control unit.

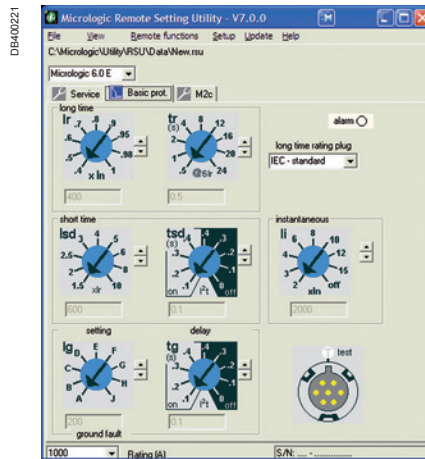

- **Service** can be used to display and set the metering and communication parameters.

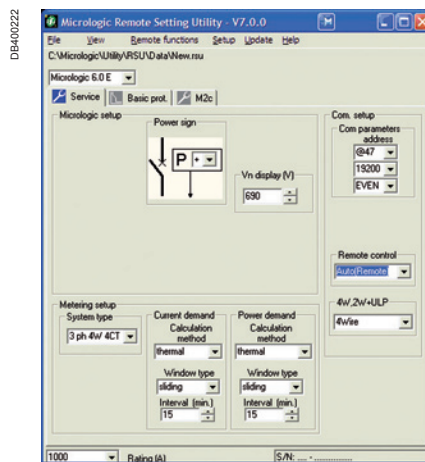

Two additional settings, not available via the control unit HMI, are also accessible:

- the "Vn display (V)" setting lets you set the nominal voltage of the power system, fixing the reference value for the percent voltage indications displayed on the FDM121 front display module.
- the "Remote control" setting lets you select either Auto(Remote) or Manu(Local) control of circuit breaker opening and closing operations (for circuit breakers equipped with a motorised communicating remote operating mechanism):
 - Auto (Remote) mode is via the communication option and a PC running suitable software (e.g. RCU Remote Control Utility).
 - Manu (Local) mode is via the Control menu of the FDM121 front display module (see page 43).

Important: In both modes, the manual operating controls on the front of the circuit breaker remain operational and take priority over remote or FDM121 control commands.

■ **M2c** can be used to set the optional M2C contacts for the programmable outputs of Micrologic E control units. You can set both the alarm or pre-alarm to be assigned to the output and the operating mode (non-latching contact = Normal mode). For further information, see "Optional M2C contacts for Micrologic E programmable outputs" on 38.

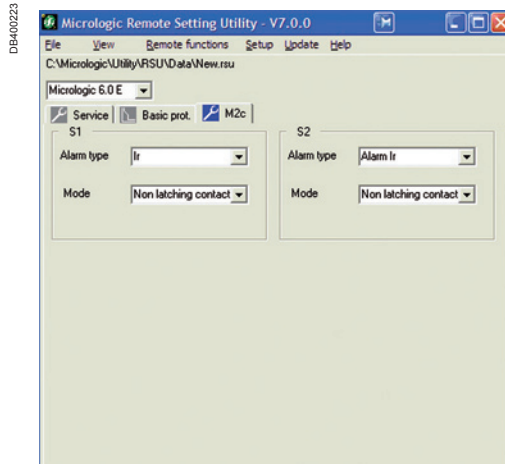

RSU operating modes

RSU software can be used in two operating modes:

- **Offline mode** does not require the PC to be connected to the Micrologic control unit. This mode lets the user prepare settings, checking that they are compatible with the control unit and applicable standards, and then save them for subsequent uploading and use in the Micrologic control unit.
- **Online mode** requires the PC to be connected to the Micrologic control unit via the communication option. This mode lets the user:
 - perform remotely all the functions normally available via the HMI using the keypad on the Micrologic control unit
 - upload or download all the settings to or from the Micrologic control unit

Measurement ranges and accuracy

The accuracy of the current measurements depends on both the value displayed (or transmitted) and the circuit-breaker rating (I_n):

- below $0.1 \times I_n$, measurements are not significant
- between $0.1 \times I_n$ and $0.2 \times I_n$, accuracy changes linearly from 4 % to 1.5 %
- between $0.2 \times I_n$ and $1.2 \times I_n$, accuracy = 1.5 %.

The resolution for the current is one Ampere.

The resolution for the voltage is one Volt.

The resolution for power is one kW, kVar, kVA.

The resolution for energy is one kWh, kVarh, kVAh.

Type	Accuracy at 25 °C	Measurement range for specified accuracy
Instantaneous current		
I1, I2, I3	±1.5 %	$0.2 \times I_n \dots 1.2 \times I_n$
IN	±1.5 %	$0.2 \times I_n \dots 1.2 \times I_n$
I ⊥ ground	±10 %	$0.2 \times I_n \dots I_n$
I ⊥ earth leakage	±1.5 %	0 to 30 A
Current maximeters		
I1 max, I2 max, I3 max	±1.5 %	$0.2 \times I_n \dots 1.2 \times I_n$
IN max	±1.5 %	$0.2 \times I_n \dots 1.2 \times I_n$
Demand current		
I1, I2, I3	±1.5 %	$0.2 \times I_n \dots 1.2 \times I_n$
IN	±1.5 %	$0.2 \times I_n \dots 1.2 \times I_n$
Demand current maximeters		
I1 max, I2 max, I3 max	±1.5 %	$0.2 \times I_n \dots 1.2 \times I_n$
IN max	±1.5 %	$0.2 \times I_n \dots 1.2 \times I_n$
Phase-to-phase voltages (3 and 4-wire systems)		
V12	±0.5 %	100 ... 690 V
V23	±0.5 %	100 ... 690 V
V31	±0.5 %	100 ... 690 V
Phase-to-neutral voltages (4-wire systems) ⁽¹⁾		
V1N	±0.5 %	100 ... 690 V
V2N	±0.5 %	100 ... 690 V
V3N	±0.5 %	100 ... 690 V
Average voltage		
Vavg	±0.5 %	0 ... 100 %
Voltage unbalance		
U unbal	±0.5 %	0 ... 100 %
Instantaneous power		
P (per phase)	±2 %	30...2000 kW
Q (per phase)	±2 %	30...2000 kVar
S (per phase)	±2 %	30...2000 kVA
Power maximeters		
P max (per phase)	±2 %	30...2000 kW
Q max (per phase)	±2 %	30...2000 kVar
S max (per phase)	±2 %	30...2000 kVA
Demand power		
P (per phase)	±2 %	30...2000 kW
S (per phase)	±2 %	30...2000 kVA
Demand power maximeters		
P max (per phase)	±2 %	30...2000 kW
Instantaneous power factor		
PF	±2 %	0 ... +1
Total energy		
Ep	±2 %	-10^{10} GWh ... $+10^{10}$ GWh
Eq	±2 %	-10^{10} GVarh ... $+10^{10}$ GVarh
Es	±2 %	-10^{10} GVAh ... $+10^{10}$ GVAh

(1) Important: for 3-pole circuit breakers used on 4-wire systems (3ph + N), terminal VN on the Micrologic control unit must always be connected to the neutral. If this is not done, the phase-to-neutral voltage measurements can be erroneous.

A	
Active, reactive, apparent energy	15, 16, 44
Active, reactive, apparent power	16, 44
Address	38, 39, 52
Alarm	40, 43
B	
Baud rate	30, 32, 39, 52
C	
COM communication option	39, 440
Contact	38
Control unit identification	2
Control-unit battery	36
D	
Date and time	28, 40
Demand current	16, 40, 52, 53
Demand current calculation	32, 40, 52
Demand power	16, 40, 52, 53
Demand power calculation	32, 40, 52
Demand power maximeters	15, 53
E	
Earth-leakage protection	13, 40
F	
Fault	14, 36
Full neutral protection	12
Ground-fault protection	13, 17, 28, 40, 47, 51
H	
Half neutral protection	12
I	
I_{\perp} ground	53
I_{\perp} earth leakage	53
I^2t	11
I_g pickup	17
Infrared link	3
Instantaneous current	16, 23, 24, 25, 53
Instantaneous power	15, 54
Instantaneous protection	11, 28, 40
I_r current setting	17
I_{sd} pickup	11, 29
L	
Language	30
Latching	38
LEDs	3, 43
Long-time protection	10, 28, 40
M	
M2C	38
Maximum of instantaneous current	23, 27
Metering menu	43
Modbus address	30, 32, 34
Modbus communication	39
Modbus connection	32, 52
N	
Neutral protection	12

P	
Parity	30, 32, 52
Phase-to-neutral and phase-to-phase voltage	15, 25, 40, 53
Portable test kit	4
Power maximeter	15, 16, 53
Power sign	52
R	
Remote control	52
Resetting the fault indications	36
Resetting the maximum instantaneous current values	27
Resetting the total active energy	27
S	
Short-time protection	11, 28, 40, 51
System type	52
T	
Test connector	3
tg tripping delay	3, 13, 29
Thermal memory	10, 51
tr tripping delay	3, 13, 29
Trip history	17, 23, 25, 28
Tripping curves	46
tsd tripping delay	3, 11, 29
Tripping delay Δt	13
U	
ULP system	41
U unbal	53
V	
V unbal	16
Voltage V avg	16
Z	
Zone selective interlocking	49

Notes

Notes

Notes

Schneider Electric Industries SAS

35, rue Joseph Monier
CS 30323
F- 92506 Rueil Malmaison Cedex

RCS Nanterre 954 503 439
Capital social 896 313 776 €
www.schneider-electric.com

As standards, specifications and designs change from time to time, please ask for confirmation of the information given in this publication.



This document has been printed on ecological paper

Design: Schneider Electric
Photos: Schneider Electric
Printed: