

Millenium

An element of sophistication



- ABB's signature range includes additional functions such as ABB-free@home® Wireless and the new USB chargers.
- Slim design, only 4 mm height of the cover frames.
- Two different rocker sizes: Premium and Standard for the light switches.
- Including two glass colors, black and white, and the recently launched Dune Sand and Mocha Brown new colors.

Find exactly what you are looking for.

The Millennium series offers control, functionality and convenience that will always fit the desired look and feel of the building.

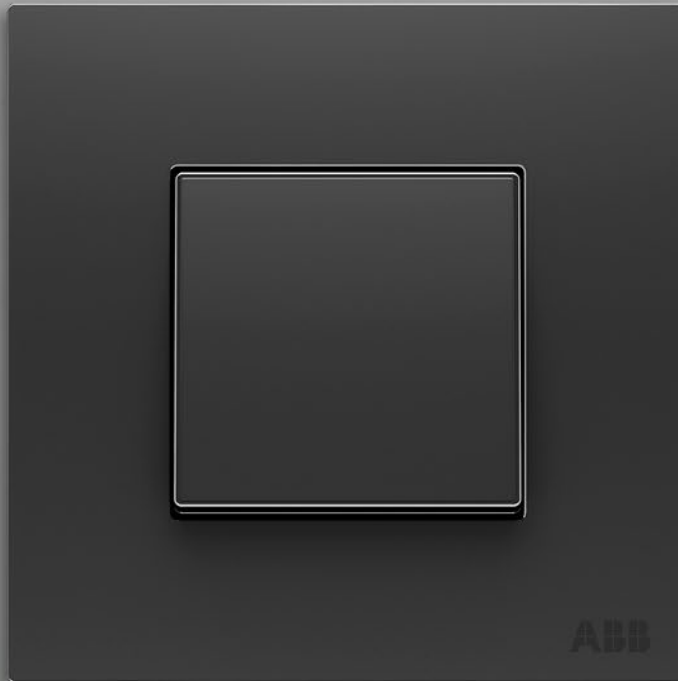



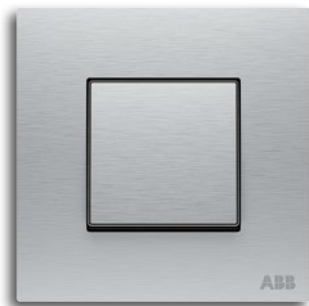

01



02

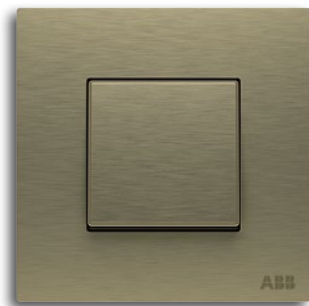

03

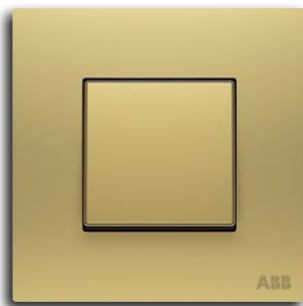

04

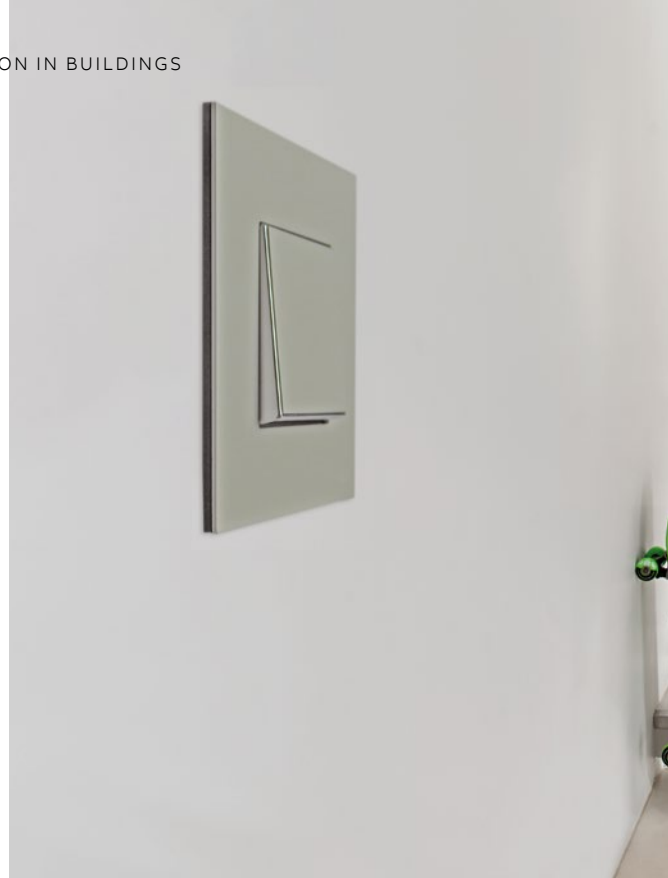

Ultra slim design in different finishes

Thanks to a combined system, the switches of the Millennium series provide a comprehensive range of solutions for single rooms or whole building concepts. The square and ultra slim switches do not only add quality and style to the overall building, but are also easy to install.



05



06

Millenium new colors

The touch of style

Today more than ever, both at home and when we visit a hotel, we need spaces that provide a sense of safety and comfort. The two new colors Mocha Brown and Dune Sand are inspired by natural elements such as coffee beans, earth or sand to bring a warm feeling to the interior design of contemporary spaces.



07

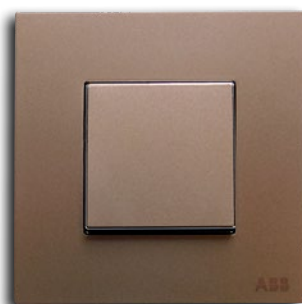

08

- 01 Stainless Steel
- 02 Silk Black *
- 03 Antique Gold
- 04 Matt Gold
- 05 White Glass
- 06 Black Glass
- 07 Dune Sand
- 08 Mocha Brown

* SB Not suitable for outdoor installations

Everything under control

The Millennium collection is the first metal range to incorporate the KNX system, the most intelligent way of managing spaces and optimizing performance in terms of energy saving.

Optimizing comfort, safety and efficiency of buildings:

- Providing with complete comfort solutions to satisfy all type of needs and projects.
- Ensuring safety and protection of persons and goods.
- Saving energy by using only the amount of energy required.



01



02



- 01 KNX 6gang sensor
- 02 KNX 6gang with IR sensor
- 03 KNX 180° movement detector
- 04 KNX room temperature controller



03



04

Freedom is a wonderful feeling

With Millenium collection ABB-free@home® all functions in the home can be managed automatically – according to time schedule, temperature and movement detector – or be called up at the touch of a button. Every combination of the various functions is possible. More comfortable living. ABB-free@home® makes daily life easier.

- 01 Switch 1/2gang, Stainless Steel
- 02 Switch 2/4gang, Stainless Steel
- 03 Movement detector, Stainless Steel
- 04 Room temperature controller, Stainless Steel



01



02



03



04





-  Blind
-  Light
-  Heating
-  Air conditioning
-  Door communication



Now scan the QR code to find out more about the advantages of ABB-free@home® abb.com/freathome

Access control: the right choice for hotels applications

ABB's access control KNX-based solutions are perfectly adaptable not only to the needs of hotel industry operators, but also to the hospitality sector in general (apartment hotels, B&Bs, holiday apartments, and resorts).

Advantages

ABB access control is based on MIFARE transponder technology, exploiting its flexibility and security:

- Simplified and centralized management of all hotel functions from the front desk via the supervision software.
- Energy efficiency and cost savings (activation of the room's electrical devices only when occupied by the guest).
- Safety, thanks to room access via transponder card.
- Additional guest services integrated, managing access to every hotel common areas.



01



02

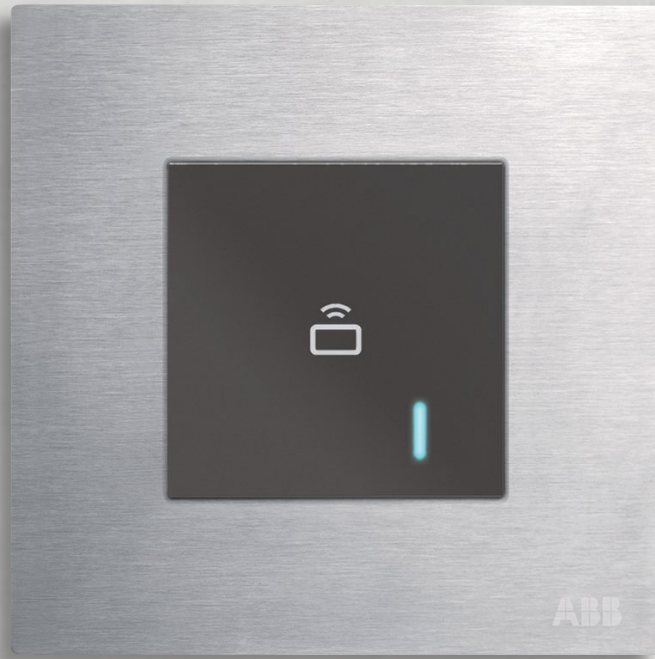

- 01 Transponder reader
- 02 Transponder holder
- 03 Set of 10 MIFARE transponder cards
- 04 MiniMAC 4.1 software



— 03



— 04

Sustainability and maximum respect for the planet

Nowadays it is not enough to simply design on the basis of aesthetics. The responsibility of manufacturers towards the environment means that they have to think about ecological designs. At ABB we are convinced that the intelligent use of technology makes sustainability and maximum respect for the planet possible. So our products care for both people and the world around them.

These are some of the environmental improvements offered by Millenium:

- Millenium light signals are based on LED technology, leading to a saving in energy consumption of 50%, and extending their life to up to 10 years.
- Recyclable packaging, optimised to reduce raw material consumption.
- Optimization of Millenium's design, production and distribution process in order to reduce the impact in the environment.
- All our products comply with ROHS.



Millenium range has been designed following the requirements of norm ISO 14006 Environmental management systems / guidelines for incorporating Ecodesign certificate.



Applications

Millenium is based on a combinable concept which creates a very comprehensive range, suitable for any type of needs. This makes it the ideal collection for all types of homes, hotels, offices, shops, etc.



Homes

Its simple and minimalist design integrates in any type of architecture, regardless of the decoration. It provides a wealth of features and value, thanks to its wide range of functions and benefits. Millenium is the perfect match to improve living space.



Hotels

Millenium is specially suitable for Hotel projects thanks to its modern design, fashion materials and functionalities that provide high comfort level to the hotel guests. Its ABB i-bus® KNX, ABB-free@home®, access control, sound system and more functions make a special contribution to the Guest Room System in the daily management of the hotel, achieving energy savings and high tech comfort.



Commercials

The Millenium collection offers elegance and distinction to commercial spaces designed for different purposes; restaurants, coffee shops, stores, offices, airports, etc.





Features and benefits

Innovation, design and technology Made in Spain

Millenium's design and functionality convert into numerous technical and installation advantages

Modern and contemporary 4 finishes made in real stainless steel material AISI 304 and 2 finishes made in glass to complete the elegant finishes of Millenium: Stainless Steel, Silk Black, Antique Gold, and Matt Gold, White Glass and Black Glass.

Designed by the famous European designer Josep LLuscá.



Slim line design, only 4 mm high with straight and square lines at the forefront. Rocker with attractive chrome profile that gives a distinctive glance.

First British Standard range with wide rocker and metal finish. Screwless front plate ultra slim design.



ABB warranty policy for Millenium collection:

- 10 years for mechanical switches and socket outlets
- 1 year for electronic devices

Large variety of sockets outlets, equipped with shutters for increased safety. Single and double pole, round pin, universal socket outlet, references with and without led indicator, 13 A and 15 A. All equipped with child protection safety shutter system.

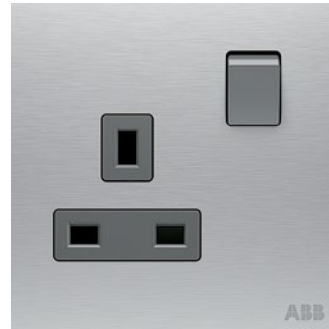

Control your LED lamps redefining the use of light and using only a 50% of the energy of conventional lamps. Comfortable light control in a trice. Press the rotary knob and dim the light darker or brighter as required. The technology of the LED dimmers is based on transistors, avoiding humming noise.

Easy to install, simple and adaptable, it allows the use of bigger screws helping installation in any situation and place. Additionally, strong centered bridles allow to absorb differences in uneven walls up to 2 mm height in order to keep the installation perfect under any circumstances.



First British Standard range of wiring accessories with Ecodesign Certificate. Millenium has been designed from its conception to reduce the environmental impact throughout the product life cycle from design, production, operation, distribution and product recall.



Millenium offers a complete solution for any commercial project and especially for hotels, including within its range of wiring accessories not only special conventional solutions for hotels (DND/MUR switch, card switch, electronic thermostat, etc) but also VDI connectors, USB charger, ABB i-bus® KNX, ABB-free@home®, access control and sound systems.

Features and benefits

Full range of ABB i-bus® KNX, ABB-free@home® sensors, innovative, intuitive and visually elegant. Millenium gives answer to the future by providing comfort, safety, and energy saving.



Millenium collection is a grid type system enabling combination of colours and products of different dimension and functionality. The three type of switch dimensions together with the ABB i-bus® KNX, ABB-free@home® sensors and other functions, have to be composed with the required frame in order to have the right assortment of functionality and design. In ABB i-bus® KNX sensors we have the possibility to adjoin to the frame the special metal mounting plate that allows to reduce the height so as to maintain the ultra slim line for KNX functionalities.



— Mounting Plate



— Premium rocker switch



— Frame

- 01 Earth Pin Child safety shutter system. Designed to inhibit access to electricity supply
- 02 Double pole switching
- 03 Four high quality finishes combinable to reach sixteen combinations in Stainless Steel material AISI 304
- 04 Styling slim-line design frontplate profile only 4 mm
- 05 Adaptable to the market wallboxes
- 06 Load indicator in blue LED. Less energy consumption, more durability and stylish signaling
- 07 Pure Stainless Steel AISI 304 with highest corrosion protection

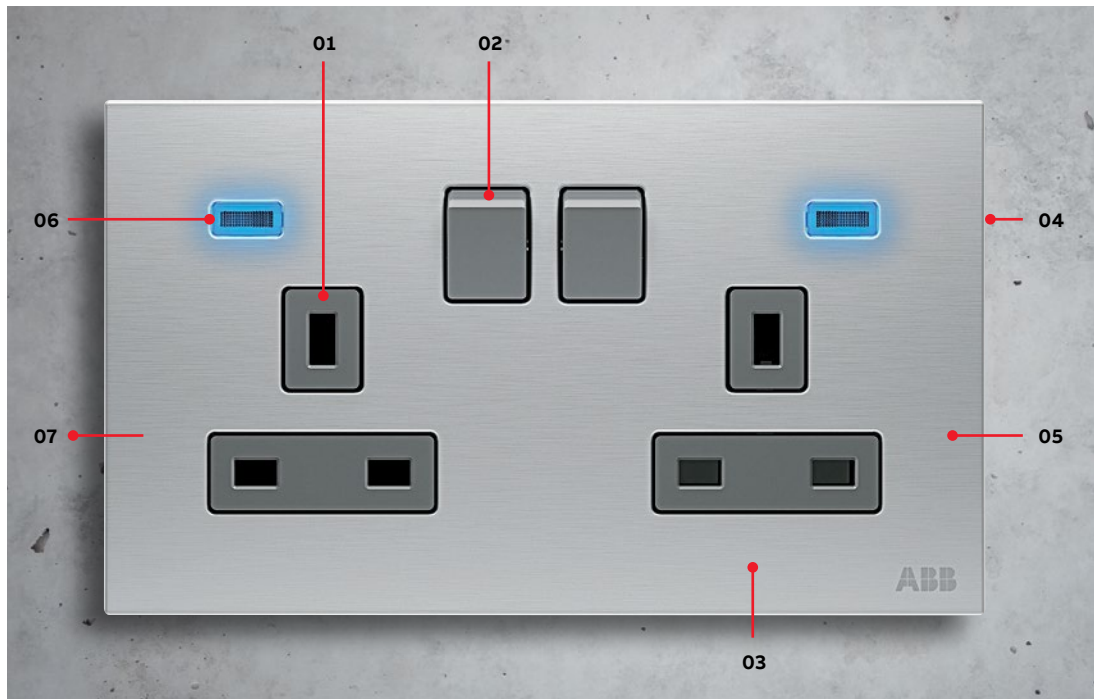

Millenium – Complete sets (AM)

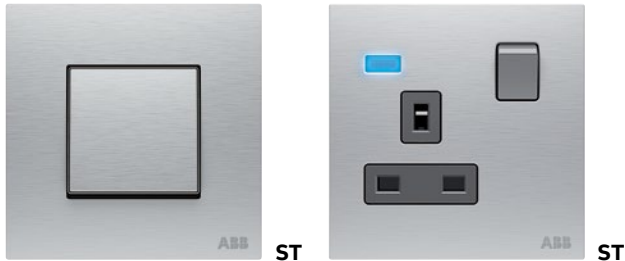









All articles in this chapter are supplied with all the necessary parts to complete the installation of the functions.

Each article includes:

- Functional module (e.g., switch, socket outlet)
- Frame / Front plate and mounting support

1 Gang switches - Standard rocker

Product	Article-No.	Order-No.	Pack/Qty
	Switch 1-gang, 1-way, SP 10AX Rated voltage: 250Vac Rated current: 10AX		
Stainless Steel	AM10120-ST	2CLA610109N1101	1
	Switch 1-gang, 2-way, SP 10AX Rated voltage: 250Vac Rated current: 10AX		
Stainless Steel	AM10520-ST	2CLA610209N1101	1
	Switch 1-gang, intermediate, SP 10AX Rated voltage: 250Vac Rated current: 10AX		
Stainless Steel	AM11920-ST	2CLA611009N1101	1
	Switch 1-gang, 1-way, SP 20AX Rated voltage: 250Vac Rated current: 20AX		
Stainless Steel	AM11020-ST	2CLA610119N1101	1
	Switch 1-gang, 2-way, SP 20 AX Rated voltage: 250Vac Rated current: 20AX		
Stainless Steel	AM11520-ST	2CLA610219N1101	1

Product	Article-No.	Order-No.	Pack/Qty
	Switch 1-gang, 1-way, DP 20AX Rated voltage: 250Vac Rated current: 20AX Status indicator LED		
Stainless Steel	AM11120-ST	2CLA610139N1101	1
	Switch 1-gang, 1-way, DP water heater 20AX Rated voltage: 250Vac Rated current: 20AX Water heater indicator LED		
Stainless Steel	AM10920-ST	2CLA610149N1101	1
	Push-button 1-gang, 1-way, SP 10A Rated voltage: 250Vac Rated current: 10A		
Stainless Steel	AM43020-ST	2CLA610409N1101	1
	Push-button 1-gang, 1-way, SP with bell symbol Rated voltage: 250Vac Rated current: 10A Bell symbol indicator LED		
Stainless Steel	AM42920-ST	2CLA610449N1101	1

* Silk Black is not suitable for outdoors installation.

Millenium - Complete sets (AM)

1 Gang switches - Premium rocker

Product	Article-No.	Order-No.	Pack/Qty
	Switch 1-gang, 1-way, SP premium 10AX Rated voltage: 250Vac Rated current: 10AX Premium size rocker		
Stainless Steel	AM10144-ST	2CLA620109N1101	1

	Switch 1-gang, 2-way, SP premium 10AX Rated voltage: 250Vac Rated current: 10AX Premium size rocker		
Stainless Steel	AM10544-ST	2CLA620209N1101	1

	Switch 1-gang, intermediate, SP premium 10AX Rated voltage: 250Vac Rated current: 10AX Premium size rocker		
Stainless Steel	AM11944-ST	2CLA621009N1101	1

	Switch 1-gang, 1-way, SP premium 20AX Rated voltage: 250Vac Rated current: 20AX Premium size rocker		
Stainless Steel	AM11044-ST	2CLA620119N1101	1

	Switch 1-gang, 2-way, SP premium 20AX Rated voltage: 250Vac Rated current: 20AX Premium size rocker		
Stainless Steel	AM11544-ST	2CLA620219N1101	1

	Switch 1-gang, 1-way, DP premium 20AX w/LED Rated voltage: 250Vac Rated current: 20A Status indicator LED Premium size rocker		
Stainless Steel	AM11144-ST	2CLA620139N1101	1

	Switch 1-gang, 1-way, DP premium 32AX w/LED Rated voltage: 250Vac Rated current: 32A Premium size rocker		
Stainless Steel	AM11244-ST	2CLA620189N1101	1

Product	Article-No.	Order-No.	Pack/Qty
	Switch 1-gang, 1-way, DP premium 45A Rated voltage: 250Vac Rated current: 45A Status indicator LED Premium size rocker		

Stainless Steel	AM17744-ST	2CLA620149N1101	1
Silk Black	AM17744-SB	2CLA620149N1501	1
Antique Gold	AM17744-AG	2CLA620149N1601	1
Matt Gold	AM17744-MG	2CLA620149N1701	1
Dune Sand	AM17744-DU	2CLA620149N6201	1
Mocha Brown	AM17744-MO	2CLA620149N6601	1
White Glass	AM17744-WG	2CLA620149N3001	1
Black Glass	AM17744-BG	2CLA620149N3101	1

	Switch 1-gang, 1-way, DP premium 45A, large size Rated voltage: 250Vac Rated current: 45A Status indicator LED Premium size rocker For 6x3 inch. boxes		
Stainless Steel	AM17844-ST	2CLA620169N1101	1
Silk Black	AM17844-SB	2CLA620169N1501	1
Antique Gold	AM17844-AG	2CLA620169N1601	1
Matt Gold	AM17844-MG	2CLA620169N1701	1
Dune Sand	AM17844-DU	2CLA620169N6201	1
Mocha Brown	AM17844-MO	2CLA620169N6601	1
White Glass	AM17844-WG	2CLA620169N3001	1
Black Glass	AM17844-BG	2CLA620169N3101	1

1 Gang push buttons - Premium rocker





	Push-button 1-gang, 1-way, SP premium 10A Rated voltage: 250Vac Rated current: 10A Premium size rocker		
Stainless Steel	AM43044-ST	2CLA620409N1101	1

	Push-button 1-gang, 1-way, SP premium w/bell symbol 10A Rated voltage: 250Vac Rated current: 10A Bell symbol indicator LED Premium size rocker		
Stainless Steel	AM42944-ST	2CLA620449N1101	1

* Silk Black is not suitable for outdoors installation.

Millenium - Complete sets (AM)



2 Gang switches

Product	Article-No.	Order-No.	Pack/Qty
	Switch 2-gang, 1-way, SP 10AX Rated voltage: 250Vac Rated current: 2 x 10AX		
Stainless Steel	AM10244-ST	2CLA621109N1101	1
	Switch 2-gang, 2-way, SP 10AX Rated voltage: 250Vac Rated current: 2 x 10AX		
Stainless Steel	AM10644-ST	2CLA622209N1101	1
	Switch 2-gang, 1-way, SP 20AX Rated voltage: 250Vac Rated current: 2 x 20AX		
Stainless Steel	AM11444-ST	2CLA621119N1101	1
	Switch 2-gang, 2-way, SP 20AX Rated voltage: 250Vac Rated current: 2 x 20AX		
Stainless Steel	AM11644-ST	2CLA622219N1101	1

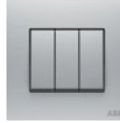
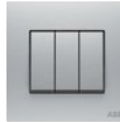
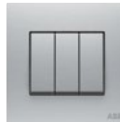
3 Gang switches

Product	Article-No.	Order-No.	Pack/Qty
	Switch 3-gang, 2-way, SP 10AX Rated voltage: 250Vac Rated current: 10AX Total		
Stainless Steel	AM10753-ST	2CLA630209N1101	1
	Switch 3-gang, 2-way, SP 16AX Rated voltage: 250Vac Rated current: 16AX Total		
Stainless Steel	AM12153-ST	2CLA630219N1101	1
	Push-button 3-gang, 1-way, SP 10AX Rated voltage: 250Vac Rated current: 10AX Total		
Stainless Steel	AM43053-ST	2CLA630409N1101	1

4 Gang switches

	Switch 4-gang, 2-way, SP 10AX Rated voltage: 250Vac Rated current: 4 x 10AX		
Stainless Steel	AM19188-ST	2CLA640209N1101	1
	Switch 4-gang, 2-way, SP 20AX Rated voltage: 250Vac Rated current: 4 x 20AX		
Stainless Steel	AM19588-ST	2CLA640219N1101	1

Other

	Fan isolator 3 poles 10A Rated voltage: 250Vac Rated current: 10A Premium size rocker		
Stainless Steel	AM13444-ST	2CLA620509N1101	1

Millenium - Complete sets (AM)

Socket outlets

Product	Article-No.	Order-No.	Pack/Qty
	BS SP switched socket outlet 13A Rated voltage: 250Vac Rated current: 13A Single pole switched Dual earth with child safety shutter system		
Stainless Steel	AM23386-ST	2CLA623739N1101	1
Silk Black	AM23386-SB	2CLA623739N1501	1
Antique Gold	AM23386-AG	2CLA623739N1601	1
Matt Gold	AM23386-MG	2CLA623739N1701	1
Dune Sand	AM23386-DU	2CLA623739N6201	1
Mocha Brown	AM23386-MO	2CLA623739N6601	1
White Glass	AM23386-WG	2CLA623739N3001	1
Black Glass	AM23386-BG	2CLA623739N3101	1

	BS SP switched socket outlet w/LED 13A Rated voltage: 250Vac Rated current: 13A Single pole switched Indicator LED Dual earth with child safety shutter system		
Stainless Steel	AM23486-ST	2CLA623749N1101	1
Silk Black	AM23486-SB	2CLA623749N1501	1
Antique Gold	AM23486-AG	2CLA623749N1601	1
Matt Gold	AM23486-MG	2CLA623749N1701	1
Dune Sand	AM23486-DU	2CLA623749N6201	1
Mocha Brown	AM23486-MO	2CLA623749N6601	1
White Glass	AM23486-WG	2CLA623749N3001	1
Black Glass	AM23486-BG	2CLA623749N3101	1

Product	Article-No.	Order-No.	Pack/Qty
	BS DP switched socket outlet 13A Rated voltage: 250Vac Rated current: 13A Double pole switched Dual earth with child safety shutter system		
Stainless Steel	AM23786-ST	2CLA623719N1101	1
Silk Black	AM23786-SB	2CLA623719N1501	1
Antique Gold	AM23786-AG	2CLA623719N1601	1
Matt Gold	AM23786-MG	2CLA623719N1701	1
Dune Sand	AM23786-DU	2CLA623719N6201	1
Mocha Brown	AM23786-MO	2CLA623719N6601	1
White Glass	AM23786-WG	2CLA623719N3001	1
Black Glass	AM23786-BG	2CLA623719N3101	1

	BS DP switched socket outlet w/LED 13A Rated voltage: 250Vac Rated current: 13A Double pole switched Indicator LED Dual earth with child safety shutter system		
Stainless Steel	AM23886-ST	2CLA623729N1101	1
Silk Black	AM23886-SB	2CLA623729N1501	1
Antique Gold	AM23886-AG	2CLA623729N1601	1
Matt Gold	AM23886-MG	2CLA623729N1701	1
Dune Sand	AM23886-DU	2CLA623729N6201	1
Mocha Brown	AM23886-MO	2CLA623729N6601	1
White Glass	AM23886-WG	2CLA623729N3001	1
Black Glass	AM23886-BG	2CLA623729N3101	1

Millenium - Complete sets (AM)

Socket outlets

Product	Article-No.	Order-No.	Pack/Qty
	BS DP switched socket outlet, 2-gang 13A Rated voltage: 250Vac Rated current: 13A Double pole switched Dual earth with child safety shutter system		
Stainless Steel	AM239147-ST	2CLA643719N1101	1
Silk Black	AM239147-SB	2CLA643719N1501	1
Antique Gold	AM239147-AG	2CLA643719N1601	1
Matt Gold	AM239147-MG	2CLA643719N1701	1
Dune Sand	AM239147-DU	2CLA643719N6201	1
Mocha Brown	AM239147-MO	2CLA643719N6601	1
White Glass	AM239147-WG	2CLA643719N3001	1
Black Glass	AM239147-BG	2CLA643719N3101	1

	BS DP switched SO w/LED, 2-gang 13A Rated voltage: 250Vac Rated current: 13A Double pole switched Indicator LED Dual earth with child safety shutter system		
Stainless Steel	AM240147-ST	2CLA643729N1101	1
Silk Black	AM240147-SB	2CLA643729N1501	1
Antique Gold	AM240147-AG	2CLA643729N1601	1
Matt Gold	AM240147-MG	2CLA643729N1701	1
Dune Sand	AM240147-DU	2CLA643729N6201	1
Mocha Brown	AM240147-MO	2CLA643729N6601	1
White Glass	AM240147-WG	2CLA643729N3001	1
Black Glass	AM240147-BG	2CLA643729N3101	1

Product	Article-No.	Order-No.	Pack/Qty
	Cooker control unit Rated voltage: 250Vac Main switch: Rated current: 45A Double pole switched Indicator LED Socket outlet: Rated current: 13A Child safety shutter system Indicator LED Flush wall box 45mm		
Stainless Steel	AM118147-ST	2CLA643749N1101	1
Silk Black	AM118147-SB	2CLA643749N1501	1
Antique Gold	AM118147-AG	2CLA643749N1601	1
Matt Gold	AM118147-MG	2CLA643749N1701	1
Dune Sand	AM118147-DU	2CLA643749N6201	1
Mocha Brown	AM118147-MO	2CLA643749N6601	1
White Glass	AM118147-WG	2CLA643749N3001	1
Black Glass	AM118147-BG	2CLA643749N3101	1

Millenium - Complete sets (AM)

Socket outlets

Product	Article-No.	Order-No.	Pack/Qty
	BS DP round pin switched outlet 5A Rated voltage: 250Vac Rated current: 5A Double pole switch Child safety shutter system		
Stainless Steel	AM22186-ST	2CLA623759N1101	1
Silk Black	AM22186-SB	2CLA623759N1501	1
Antique Gold	AM22186-AG	2CLA623759N1601	1
Matt Gold	AM22186-MG	2CLA623759N1701	1
Dune Sand	AM22186-DU	2CLA623759N6201	1
Mocha Brown	AM22186-MO	2CLA623759N6601	1
White Glass	AM22186-WG	2CLA623759N3001	1
Black Glass	AM22186-BG	2CLA623759N3101	1

	BS DP round pin switched outlet 15A Rated voltage: 250Vac Rated current: 15A Double pole switch Child safety shutter system		
Stainless Steel	AM20986-ST	2CLA623769N1101	1
Silk Black	AM20986-SB	2CLA623769N1501	1
Antique Gold	AM20986-AG	2CLA623769N1601	1
Matt Gold	AM20986-MG	2CLA623769N1701	1
Dune Sand	AM20986-DU	2CLA623769N6201	1
Mocha Brown	AM20986-MO	2CLA623769N6601	1
White Glass	AM20986-WG	2CLA623769N3001	1
Black Glass	AM20986-BG	2CLA623769N3101	1

Product	Article-No.	Order-No.	Pack/Qty
	BS DP round pin switched outlet w/LED 15A Rated voltage: 250Vac Rated current: 15A Double pole switch Indicator LED Child safety shutter system		
Stainless Steel	AM23186-ST	2CLA623779N1101	1
Silk Black	AM23186-SB	2CLA623779N1501	1
Antique Gold	AM23186-AG	2CLA623779N1601	1
Matt Gold	AM23186-MG	2CLA623779N1701	1
Dune Sand	AM23186-DU	2CLA623779N6201	1
Mocha Brown	AM23186-MO	2CLA623779N6601	1
White Glass	AM23186-WG	2CLA623779N3001	1
Black Glass	AM23186-BG	2CLA623779N3101	1

	Universal switched socket outlet 13A Rated voltage: 250Vac Rated current: 13A Double pole switch Child safety shutter system		
Stainless Steel	AM29486-ST	2CLA623919N1101	1
Silk Black	AM29486-SB	2CLA623919N1501	1
Antique Gold	AM29486-AG	2CLA623919N1601	1
Matt Gold	AM29486-MG	2CLA623919N1701	1
Dune Sand	AM29486-DU	2CLA623919N6201	1
Mocha Brown	AM29486-MO	2CLA623919N6601	1
White Glass	AM29486-WG	2CLA623919N3001	1
Black Glass	AM29486-BG	2CLA623919N3101	1

Millenium - Complete sets (AM)

Socket outlets with USB charger

Product	Article-No.	Order-No.	Pack/Qty
	BS Single socket outlet 13A, with USB-Charger Type-C, DP switch Rated voltage: 250 Vac Rated current: 13A Double pole switch USB-C 18 W. with Advanced Charging Includes child safety shutter Includes frame and metal support with twin earth		
Stainless Steel	AM24286-ST	2CLA623799N1101	1
Silk Black	AM24286-SB	2CLA623799N1501	1
Antique Gold	AM24286-AG	2CLA623799N1601	1
Matt Gold	AM24286-MG	2CLA623799N1701	1
Dune Sand	AM24286 DU	2CLA623799N6201	1
Mocha Brown	AM24286 MO	2CLA623799N6601	1
White Glass	AM24286-WG	2CLA623799N3001	1
Black Glass	AM24286-BG	2CLA623799N3101	1

	BS Single socket outlet 13A, with USB-Charger Type-A, SP switch Rated voltage: 250Vac / 50-60 Hz Rated current: 13A Single pole switch USB charger type A: 10.5W (5V - 2.1A)		
Stainless Steel	AM23586-ST	2CLA623788N1101	1
Silk Black	AM23586-SB	2CLA623788N1501	1
Antique Gold	AM23586-AG	2CLA623788N1601	1
Matt Gold	AM23586-MG	2CLA623788N1701	1
Dune Sand	AM23586-DU	2CLA623788N6201	1
Mocha Brown	AM23586-MO	2CLA623788N6601	1
White Glass	AM23586-WG	2CLA623788N3001	1
Black Glass	AM23586-BG	2CLA623788N3101	1

	BS Single socket outlet 13A, with USB-Charger Type-A, unswitched Rated voltage: 250Vac / 50-60 Hz Rated current: 13A Unswitched USB charger type A: 10.5W (5V - 2.1A)		
Stainless Steel	AM23686-ST	2CLA623798N1101	1
Silk Black	AM23686-SB	2CLA623798N1501	1
Antique Gold	AM23686-AG	2CLA623798N1601	1
Matt Gold	AM23686-MG	2CLA623798N1701	1
Dune Sand	AM23686-DU	2CLA623798N6201	1
Mocha Brown	AM23686-MO	2CLA623798N6601	1
White Glass	AM23686-WG	2CLA623798N3001	1
Black Glass	AM23686-BG	2CLA623798N3101	1

Product	Article-No.	Order-No.	Pack/Qty
	BS Double socket outlet 13A, with USB-Charger Type-C+A, DP switch Rated voltage: 250 Vac. Rated current: 13A Double pole switch USB-C 18 W. with Advanced Charging USB-A 18 W. (shared) Includes child safety shutter Includes frame and metal support with twin earth		
Stainless Steel	AM242147-ST	2CLA643799N1101	1
Silk Black	AM242147-SB	2CLA643799N1501	1
Antique Gold	AM242147-AG	2CLA643799N1601	1
Matt Gold	AM242147-MG	2CLA643799N1701	1
Dune Sand	AM242147-DU	2CLA643799N6201	1
Mocha Brown	AM242147-MO	2CLA643799N6601	1
White Glass	AM242147-WG	2CLA643799N3001	1
Black Glass	AM242147-BG	2CLA643799N3101	1

	BS Double socket outlet 13A, with USB-Charger Type-A, DP switch Rated voltage: 250Vac / 50-60 Hz Rated current: 13A Single pole switch USB charger type A: 13W (5V - 2.6A)		
Stainless Steel	AM235147-ST	2CLA643788N1101	1
Silk Black	AM235147-SB	2CLA643788N1501	1
Antique Gold	AM235147-AG	2CLA643788N1601	1
Matt Gold	AM235147-MG	2CLA643788N1701	1
Dune Sand	AM235147-DU	2CLA643788N6201	1
Mocha Brown	AM235147-MO	2CLA643788N6601	1
White Glass	AM235147-WG	2CLA643788N3001	1
Black Glass	AM235147-BG	2CLA643788N3101	1

	BS Double socket outlet 13A, with USB-Charger Type-A, unswitched Rated voltage: 250Vac / 50-60 Hz Rated current: 13A Unswitched USB charger type A: 13W (5V - 2.6A)		
Stainless Steel	AM236147-ST	2CLA643798N1101	1
Silk Black	AM236147-SB	2CLA643798N1501	1
Antique Gold	AM236147-AG	2CLA643798N1601	1
Matt Gold	AM236147-MG	2CLA643798N1701	1
Dune Sand	AM236147-DU	2CLA643798N6201	1
Mocha Brown	AM236147-MO	2CLA643798N6601	1
White Glass	AM236147-WG	2CLA643798N3001	1
Black Glass	AM236147-BG	2CLA643798N3101	1

Millenium - Complete sets (AM)

Fuse Connection Unit

Product	Article-No.	Order-No.	Pack/Qty
	Fuse connection unit w/flex outlet 13A Rated voltage: 230Vac. Rated current: 13A Fuse size: Ø6.3x25mm Fuse breaking capacity: 6kA 264V~ 50Hz Fuse according to BS1362		
Stainless Steel	AM50653-ST	2CLA630809N1101	1
Silk Black	AM50653-SB	2CLA630809N1501	1
Antique Gold	AM50653-AG	2CLA630809N1601	1
Matt Gold	AM50653-MG	2CLA630809N1701	1
Dune Sand	AM50653-DU	2CLA630809N6201	1
Mocha Brown	AM50653-MO	2CLA630809N6601	1
White Glass	AM50653-WG	2CLA630809N3001	1
Black Glass	AM50653-BG	2CLA630809N3101	1

	Fuse connection unit w/flex outlet w/LED 13A Rated voltage: 230Vac. Rated current: 13A Fuse size: Ø6.3x25mm Fuse breaking capacity: 6kA 264V~ 50Hz Fuse according to BS1362. Status indicator LED		
Stainless Steel	AM50853-ST	2CLA630859N1101	1
Silk Black	AM50853-SB	2CLA630859N1501	1
Antique Gold	AM50853-AG	2CLA630859N1601	1
Matt Gold	AM50853-MG	2CLA630859N1701	1
Dune Sand	AM50853-DU	2CLA630859N6201	1
Mocha Brown	AM50853-MO	2CLA630859N6601	1
White Glass	AM50853-WG	2CLA630859N3001	1
Black Glass	AM50853-BG	2CLA630859N3101	1

	Switched fuse connection unit w/flex outlet w/LED 13A Rated voltage: 230Vac. Rated current: 13A Fuse size: Ø6.3x25mm Fuse breaking capacity: 6kA 264V~ 50Hz Fuse according to BS1362. Status indicator LED		
Stainless Steel	AM50753-ST	2CLA630829N1101	1
Silk Black	AM50753-SB	2CLA630829N1501	1
Antique Gold	AM50753-AG	2CLA630829N1601	1
Matt Gold	AM50753-MG	2CLA630829N1701	1
Dune Sand	AM50753-DU	2CLA630829N6201	1
Mocha Brown	AM50753-MO	2CLA630829N6601	1
White Glass	AM50753-WG	2CLA630829N3001	1
Black Glass	AM50753-BG	2CLA630829N3101	1

	Flex outlet 20A Rated current: 20A		
Stainless Steel	AM55044-ST	2CLA620729N1101	1
Silk Black	AM55044-SB	2CLA620729N1501	1
Antique Gold	AM55044-AG	2CLA620729N1601	1
Matt Gold	AM55044-MG	2CLA620729N1701	1
Dune Sand	AM55044-DU	2CLA620729N6201	1
Mocha Brown	AM55044-MO	2CLA620729N6601	1
White Glass	AM55044-WG	2CLA620729N3001	1
Black Glass	AM55044-BG	2CLA620729N3101	1

Millenium - Complete sets (AM)

Flexible Outlets

Product	Article-No.	Order-No.	Pack/Qty
	Flex outlet 45A Rated current: 45A		
Anthracite P	AM56086-AN	2CLA620739N1801	1
White	AM56086-WP	2CLA620739N2001	1

Dimmers





	Double LED/Universal Rotary dimmer Rated voltage: 250Vac / 50-60 Hz Power (min./max load): - LEDi (trailing-edge lamps): 4 / 250 W/VA. - LEDi (leading-edge lamps): 4 / 60 W/VA.* - LV LEDi with transformer type C: 4 / 250 W/VA. - LV LEDi with transformer type LC: 4 / 60 W/VA.* - LV halogen with transformer type C: 4 / 250 W/VA. - LV halogen with transformer type LC: 4 / 250 W/VA. - Incandescent lamps: 4 / 250 W/VA. - Halogen lamps: 4 / 250 W/VA. *Max. 10 lamps.		
Stainless Steel	AM41144-ST	2CLA616049N1101	1
Silk Black	AM41144-SB	2CLA616049N1501	1
Antique Gold	AM41144-AG	2CLA616049N1601	1
Matt Gold	AM41144-MG	2CLA616049N1701	1
Dune Sand	AM41144-DU	2CLA616049N6201	1
Mocha Brown	AM41144-MO	2CLA616049N6601	1
White Glass	AM41144-WG	2CLA616049N3001	1
Black Glass	AM41144-BG	2CLA616049N3101	1



	Rotary dimmer Rated voltage: 250V~ +/-10 50 Hz. Min. power: 40W / VA. Max. power: - Incandescent lamps: 400W. - Halogen lamps with ferromagnetic transformers: 300 VA. Operating temperature: 0° C to +30° C.		
Stainless Steel	AM41344-ST	2CLA626039N1101	1
Silk Black	AM41344-SB	2CLA626039N1501	1
Antique Gold	AM41344-AG	2CLA626039N1601	1
Matt Gold	AM41344-MG	2CLA626039N1701	1
Dune Sand	AM41344-DU	2CLA626039N6201	1
Mocha Brown	AM41344-MO	2CLA626039N6601	1
White Glass	AM41344-WG	2CLA626039N3001	1
Black Glass	AM41344-BG	2CLA626039N3101	1

For more functions such as TV or data outlets, please see Modular system catalogue pages.

Millenium - Complete sets (AM)

Hotel equipment

Product	Article-No.	Order-No.	Pack/Qty
	Push button, DND/MUR with bell symbol 10A Rated voltage: 250Vac Rated current 10A Red LED: "Do Not Disturb" Green LED: "Make Up Room" Premium size rocker		
Stainless Steel	AM40344-ST	2CLA621589N1101	1
	Switch 2-gang, DND/MUR 10AX Rated voltage: 250Vac Rated current 10AX Red LED: "Do Not Disturb" Green LED: "Make Up Room" LED signaling		
Stainless Steel	AM40444-ST	2CLA621509N1101	1
	Switch blind control Rated voltage 250Vac Rated current 16AX Output: 2 normally open contact Multi-way input terminal (up/down)		
Stainless Steel	AM11844-ST	2CLA624419N1101	1
	Shaver socket outlet Rated voltage: 20VA / 230Vac Outputs: 115V and 230V Dimensions: 150x90x54mm Flush wall box not included (45mm depth minimum)		
Stainless Steel	AM40188-ST	2CLA680309N1101	1
Silk Black	AM40188-SB	2CLA680309N1501	1
Antique Gold	AM40188-AG	2CLA680309N1601	1
Matt Gold	AM40188-MG	2CLA680309N1701	1
Dune Sand	AM40188-DU	2CLA680309N6201	1
Mocha Brown	AM40188-MO	2CLA680309N6601	1
White Glass	AM40188-WG	2CLA680309N3001	1
Black Glass	AM40188-BG	2CLA680309N3101	1
	Flush mounting box For shaver socket outlet AM40188-XX Dimensions: 135,5 x 74 x 50 mm"		
	803.2	2CLA080320A1001	1

Product	Article-No.	Order-No.	Pack/Qty
	Electronic card switch 16AX Rated voltage: 250Vac Rated current: 16AX Includes indication LED Time relay : 5-90 sec. Cards up to 54 mm width.		
Stainless Steel	AM40544-ST	2CLA621459N1101	1
Silk Black	AM40544-SB	2CLA621459N1501	1
Antique Gold	AM40544-AG	2CLA621459N1601	1
Matt Gold	AM40544-MG	2CLA621459N1701	1
Dune Sand	AM40544-DU	2CLA621459N6201	1
Mocha Brown	AM40544-MO	2CLA621459N6601	1
White Glass	AM40544-WG	2CLA621459N3001	1
Black Glass	AM40544-BG	2CLA621459N3101	1
	Card switch 16AX Rated voltage: 250Vac Rated current: 16AX Includes indication LED		
Stainless Steel	AM40244-ST	2CLA621419N1101	1
Silk Black	AM40244-SB	2CLA621419N1501	1
Antique Gold	AM40244-AG	2CLA621419N1601	1
Matt Gold	AM40244-MG	2CLA621419N1701	1
Dune Sand	AM40244-DU	2CLA621419N6201	1
Mocha Brown	AM40244-MO	2CLA621419N6601	1
White Glass	AM40244-WG	2CLA621419N3001	1
Black Glass	AM40244-BG	2CLA621419N3101	1
	Spare Led for card switches Rated voltage: 250Vac Rated current: 0.7mA Frontal replacement.		
	AM50093-BL	2CLA619309N1001	1

Millenium - Modular System (AMD)

The modular system of Millenium (AMD) is a clever solution to allow users to combine different functions, frames and colors.

The functions can be combined with specific frames in order to complete the installation.

The table showing the full set of frames can be found at the end of the chapter.

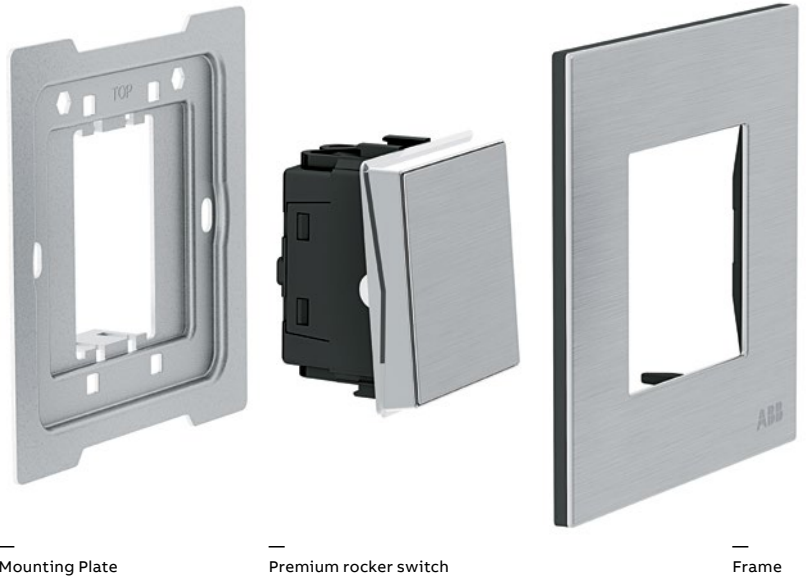



Mounting Plate

Premium rocker switch

Frame

Standard rocker switch

Product	Article-No.	Order-No.	Pack/Qty
	Switch 1-gang, 1-way, SP 10AX Rated voltage: 250Vac Rated current: 10AX		
Stainless Steel	AMD10120-ST	2CLA610100N1101	10
Silk Black	AMD10120-SB	2CLA610100N1501	10
Antique Gold	AMD10120-AG	2CLA610100N1601	10
Matt Gold	AMD10120-MG	2CLA610100N1701	10
Dune Sand	AMD10120-DU	2CLA610100N6201	10
Mocha Brown	AMD10120-MO	2CLA610100N6601	10
White Glass	AMD10120-WG	2CLA610100N3001	10
Black Glass	AMD10120-BG	2CLA610100N3101	10

Product	Article-No.	Order-No.	Pack/Qty
	Switch 1-gang, intermediate, SP 10AX Rated voltage: 250Vac Rated current: 10AX		
Stainless Steel	AMD11920-ST	2CLA611000N1101	10
Silk Black	AMD11920-SB	2CLA611000N1501	10
Antique Gold	AMD11920-AG	2CLA611000N1601	10
Matt Gold	AMD11920-MG	2CLA611000N1701	10
Dune Sand	AMD11920-DU	2CLA611000N6201	10
Mocha Brown	AMD11920-MO	2CLA611000N6601	10
White Glass	AMD11920-WG	2CLA611000N3001	5
Black Glass	AMD11920-BG	2CLA611000N3101	5

	Switch 1-gang, 2-way, SP 10AX Rated voltage: 250Vac Rated current: 10AX		
Stainless Steel	AMD10520-ST	2CLA610200N1101	10
Silk Black	AMD10520-SB	2CLA610200N1501	10
Antique Gold	AMD10520-AG	2CLA610200N1601	10
Matt Gold	AMD10520-MG	2CLA610200N1701	10
Dune Sand	AMD10520-DU	2CLA610200N6201	10
Mocha Brown	AMD10520-MO	2CLA610200N6601	10
White Glass	AMD10520-WG	2CLA610200N3001	5
Black Glass	AMD10520-BG	2CLA610200N3101	5

	Switch 1-gang, 1-way, SP 20AX Rated voltage: 250Vac Rated current: 20AX		
Stainless Steel	AMD11020-ST	2CLA610110N1101	10
Silk Black	AMD11020-SB	2CLA610110N1501	10
Antique Gold	AMD11020-AG	2CLA610110N1601	10
Matt Gold	AMD11020-MG	2CLA610110N1701	10
Dune Sand	AMD11020-DU	2CLA610110N6201	10
Mocha Brown	AMD11020-MO	2CLA610110N6601	10
White Glass	AMD11020-WG	2CLA610110N3001	10
Black Glass	AMD11020-BG	2CLA610110N3101	10

Millenium - Modular System (AMD)

Standard rocker switch and push buttons







Product	Article-No.	Order-No.	Pack/Qty
	Switch 1-gang, 2-way, SP 20AX Rated voltage: 250Vac Rated current: 20AX		
Stainless Steel	AMD11520-ST	2CLA610210N1101	10
Silk Black	AMD11520-SB	2CLA610210N1501	10
Antique Gold	AMD11520-AG	2CLA610210N1601	10
Matt Gold	AMD11520-MG	2CLA610210N1701	10
Dune Sand	AMD11520-DU	2CLA610210N6201	10
Mocha Brown	AMD11520-MO	2CLA610210N6601	10
White Glass	AMD11520-WG	2CLA610210N3001	5
Black Glass	AMD11520-BG	2CLA610210N3101	5

	Switch 1-gang, 1-way, DP 20AX Rated voltage: 250Vac Rated current: 20AX Status indicator LED		
Stainless Steel	AMD11120-ST	2CLA610130N1101	10
Silk Black	AMD11120-SB	2CLA610130N1501	10
Antique Gold	AMD11120-AG	2CLA610130N1601	10
Matt Gold	AMD11120-MG	2CLA610130N1701	10
Dune Sand	AMD11120-DU	2CLA610130N6201	10
Mocha Brown	AMD11120-MO	2CLA610130N6601	10
White Glass	AMD11120-WG	2CLA610130N3001	5
Black Glass	AMD11120-BG	2CLA610130N3101	5

	Switch 1-gang, 1-way, DP water heater 20AX Rated voltage: 250Vac Rated current: 20AX Water heater indicator LED		
Stainless Steel	AMD10920-ST	2CLA610140N1101	10
Silk Black	AMD10920-SB	2CLA610140N1501	10
Antique Gold	AMD10920-AG	2CLA610140N1601	10
Matt Gold	AMD10920-MG	2CLA610140N1701	10
Dune Sand	AMD10920-DU	2CLA610140N6201	10
Mocha Brown	AMD10920-MO	2CLA610140N6601	10
White Glass	AMD10920-WG	2CLA610140N3001	5
Black Glass	AMD10920-BG	2CLA610140N3101	5

Product	Article-No.	Order-No.	Pack/Qty
	Push-button 1-gang, 1-way, SP 10A Rated voltage: 250Vac Rated current: 10A		
Stainless Steel	AMD43020-ST	2CLA610400N1101	10
Silk Black	AMD43020-SB	2CLA610400N1501	10
Antique Gold	AMD43020-AG	2CLA610400N1601	10
Matt Gold	AMD43020-MG	2CLA610400N1701	10
Dune Sand	AMD43020-DU	2CLA610400N6201	10
Mocha Brown	AMD43020-MO	2CLA610400N6601	10
White Glass	AMD43020-WG	2CLA610400N3001	5
Black Glass	AMD43020-BG	2CLA610400N3101	5

	Push-button 1-gang, 1-way, SP with bell symbol 10A Rated voltage: 250Vac Rated current: 10A Bell symbol indicator LED		
Stainless Steel	AMD42920-ST	2CLA610440N1101	10
Silk Black	AMD42920-SB	2CLA610440N1501	10
Antique Gold	AMD42920-AG	2CLA610440N1601	10
Matt Gold	AMD42920-MG	2CLA610440N1701	10
Dune Sand	AMD42920-DU	2CLA610440N6201	10
Mocha Brown	AMD42920-MO	2CLA610440N6601	10
White Glass	AMD42920-WG	2CLA610440N3001	5
Black Glass	AMD42920-BG	2CLA610440N3101	5

						For use with: AM11120-XX, AMD11120-XX, AM18120-XX, AMD18120-XX, AM42920-XX, AMD42920-XX, AM42944-XX and AMD42944-XX.
Key symbol	AM50100-CH	2CLA600100N1101	10			
Fan symbol	AM50200-CH	2CLA600100N1201	10			
Wc symbol	AM50300-CH	2CLA600100N1301	10			
Room service symbol	AM50400-CH	2CLA600100N1401	10			
Nurse symbol	AM50500-CH	2CLA600100N1501	10			
Stop symbol	AM50600-CH	2CLA600100N1601	10			

Millenium - Modular System (AMD)

Premium rocker switch and push buttons

Product	Article-No.	Order-No.	Pack/Qty
---------	-------------	-----------	----------



Switch 1-gang, 1-way, SP premium 10AX
 Rated voltage: 250Vac
 Rated current: 10AX
 Premium size rocker

Stainless Steel	AMD10144-ST	2CLA620100N1101	10
Silk Black	AMD10144-SB	2CLA620100N1501	10
Antique Gold	AMD10144-AG	2CLA620100N1601	10
Matt Gold	AMD10144-MG	2CLA620100N1701	10
Dune Sand	AMD10144-DU	2CLA620100N6201	10
Mocha Brown	AMD10144-MO	2CLA620100N6601	10
White Glass	AMD10144-WG	2CLA620100N3001	5
Black Glass	AMD10144-BG	2CLA620100N3101	5



Switch 1-gang, 2-way, SP premium 10AX
 Rated voltage: 250Vac
 Rated current: 10AX
 Premium size rocker

Stainless Steel	AMD10544-ST	2CLA620200N1101	10
Silk Black	AMD10544-SB	2CLA620200N1501	10
Antique Gold	AMD10544-AG	2CLA620200N1601	10
Matt Gold	AMD10544-MG	2CLA620200N1701	10
Dune Sand	AMD10544-DU	2CLA620200N6201	10
Mocha Brown	AMD10544-MO	2CLA620200N6601	10
White Glass	AMD10544-WG	2CLA620200N3001	5
Black Glass	AMD10544-BG	2CLA620200N3101	5



Switch 1-gang, intermediate, SP premium 10AX
 Rated voltage: 250Vac
 Rated current: 10AX
 Premium size rocker

Stainless Steel	AMD11944-ST	2CLA621000N1101	10
Silk Black	AMD11944-SB	2CLA621000N1501	10
Antique Gold	AMD11944-AG	2CLA621000N1601	10
Matt Gold	AMD11944-MG	2CLA621000N1701	10
Dune Sand	AMD11944-DU	2CLA621000N6201	10
Mocha Brown	AMD11944-MO	2CLA621000N6601	10
White Glass	AMD11944-WG	2CLA621000N3001	5
Black Glass	AMD11944-BG	2CLA621000N3101	5

Product	Article-No.	Order-No.	Pack/Qty
---------	-------------	-----------	----------



Switch 1-gang, 1-way, SP premium 20AX
 Rated voltage: 250Vac
 Rated current: 20AX
 Premium size rocker

Stainless Steel	AMD11044-ST	2CLA620110N1101	10
Silk Black	AMD11044-SB	2CLA620110N1501	10
Antique Gold	AMD11044-AG	2CLA620110N1601	10
Matt Gold	AMD11044-MG	2CLA620110N1701	10
Dune Sand	AMD11044-DU	2CLA620110N6201	10
Mocha Brown	AMD11044-MO	2CLA620110N6601	10
White Glass	AMD11044-WG	2CLA620110N3001	5
Black Glass	AMD11044-BG	2CLA620110N3101	5



Switch 1-gang, 2-way, SP premium 20AX
 Rated voltage: 250Vac
 Rated current: 20AX
 Premium size rocker

Stainless Steel	AMD11544-ST	2CLA620210N1101	10
Silk Black	AMD11544-SB	2CLA620210N1501	10
Antique Gold	AMD11544-AG	2CLA620210N1601	10
Matt Gold	AMD11544-MG	2CLA620210N1701	10
Dune Sand	AMD11544-DU	2CLA620210N6201	10
Mocha Brown	AMD11544-MO	2CLA620210N6601	10
White Glass	AMD11544-WG	2CLA620210N3001	5
Black Glass	AMD11544-BG	2CLA620210N3101	5

Millenium - Modular System (AMD)

Premium rocker switch and push buttons

Product	Article-No.	Order-No.	Pack/Qty
	Switch 1-gang, 1-way, DP premium 20AX w/LED Rated voltage: 250Vac Rated current: 20A Status indicator LED Premium size rocker		
Stainless Steel	AMD11140-ST	2CLA620130N1101	10
Silk Black	AMD11140-SB	2CLA620130N1501	10
Antique Gold	AMD11140-AG	2CLA620130N1601	10
Matt Gold	AMD11140-MG	2CLA620130N1701	10
Dune Sand	AMD11140-DU	2CLA620130N6201	10
Mocha Brown	AMD11140-MO	2CLA620130N6601	10
White Glass	AMD11140-WG	2CLA620130N3001	5
Black Glass	AMD11140-BG	2CLA620130N3101	5

	Switch 1-gang, 1-way, DP premium 32A w/LED Rated voltage: 250Vac Rated current: 32A Status indicator LED Premium size rocker		
Stainless Steel	AMD11240-ST	2CLA620180N1101	10
Silk Black	AMD11240-SB	2CLA620180N1501	10
Antique Gold	AMD11240-AG	2CLA620180N1601	10
Matt Gold	AMD11240-MG	2CLA620180N1701	10
Dune Sand	AMD11240-DU	2CLA620180N6201	10
Mocha Brown	AMD11240-MO	2CLA620180N6601	10
White Glass	AMD11240-WG	2CLA620180N3001	5
Black Glass	AMD11240-BG	2CLA620180N3101	5

	Fan isolator 3 poles double 10A Rated voltage: 250Vac Rated power: 10A 3 poles		
Stainless Steel	AMD13444-ST	2CLA620500N1101	10
Silk Black	AMD13444-SB	2CLA620500N1501	10
Antique Gold	AMD13444-AG	2CLA620500N1601	10
Matt Gold	AMD13444-MG	2CLA620500N1701	10
Dune Sand	AMD13444-DU	2CLA620500N6201	10
Mocha Brown	AMD13444-MO	2CLA620500N6601	10
White Glass	AMD13444-WG	2CLA620500N3001	5
Black Glass	AMD13444-BG	2CLA620500N3101	5

Product	Article-No.	Order-No.	Pack/Qty
	Push-button 1-gang, 1-way, SP premium 10A Rated voltage: 250Vac Rated current: 10A Premium size rocker		
Stainless Steel	AMD43044-ST	2CLA620400N1101	10
Silk Black	AMD43044-SB	2CLA620400N1501	10
Antique Gold	AMD43044-AG	2CLA620400N1601	10
Matt Gold	AMD43044-MG	2CLA620400N1701	10
Dune Sand	AMD43044-DU	2CLA620400N6201	10
Mocha Brown	AMD43044-MO	2CLA620400N6601	10
White Glass	AMD43044-WG	2CLA620400N3001	5
Black Glass	AMD43044-BG	2CLA620400N3101	5

	Push-button 1-gang, 1-way, SP premium 10A w/bell symbol Rated voltage: 250Vac Rated current: 10A Bell symbol indicator LED Premium size rocker		
Stainless Steel	AMD42944-ST	2CLA620440N1101	10
Silk Black	AMD42944-SB	2CLA620440N1501	10
Antique Gold	AMD42944-AG	2CLA620440N1601	10
Matt Gold	AMD42944-MG	2CLA620440N1701	10
Dune Sand	AMD42944-DU	2CLA620440N6201	10
Mocha Brown	AMD42944-MO	2CLA620440N6601	10
White Glass	AMD42944-WG	2CLA620440N3001	5
Black Glass	AMD42944-BG	2CLA620440N3101	5

Millenium - Modular System (AMD)

Half/double rocker switches and push buttons

Product	Article-No.	Order-No.	Pack/Qty
	Switch 1-gang, 1-way, SP half rocker 10AX Rated voltage: 250Vac Rated current: 10AX Half rocker size		
Stainless Steel	AMD10222-ST	2CLA680100N1101	10
Silk Black	AMD10222-SB	2CLA680100N1501	10
Antique Gold	AMD10222-AG	2CLA680100N1601	10
Matt Gold	AMD10222-MG	2CLA680100N1701	10
Dune Sand	AMD10222-DU	2CLA680100N6201	10
Mocha Brown	AMD10222-MO	2CLA680100N6601	10
White Glass	AMD10222-WG	2CLA680100N3001	5
Black Glass	AMD10222-BG	2CLA680100N3101	5

Product	Article-No.	Order-No.	Pack/Qty
	Switch 1-gang, 1-way, SP half rocker 20AX Rated voltage: 250Vac Rated current: 20AX Half rocker size		
Stainless Steel	AMD11422-ST	2CLA680110N1101	10
Silk Black	AMD11422-SB	2CLA680110N1501	10
Antique Gold	AMD11422-AG	2CLA680110N1601	10
Matt Gold	AMD11422-MG	2CLA680110N1701	10
Dune Sand	AMD11422-DU	2CLA680110N6201	10
Mocha Brown	AMD11422-MO	2CLA680110N6601	10
White Glass	AMD11422-WG	2CLA680110N3001	5
Black Glass	AMD11422-BG	2CLA680110N3101	5

	Switch 1-gang, 2-way, SP half rocker 10AX Rated voltage: 250Vac Rated current: 10AX Half rocker size		
Stainless Steel	AMD10622-ST	2CLA680200N1101	10
Silk Black	AMD10622-SB	2CLA680200N1501	10
Antique Gold	AMD10622-AG	2CLA680200N1601	10
Matt Gold	AMD10622-MG	2CLA680200N1701	10
Dune Sand	AMD10622-DU	2CLA680200N6201	10
Mocha Brown	AMD10622-MO	2CLA680200N6601	10
White Glass	AMD10622-WG	2CLA680200N3001	5
Black Glass	AMD10622-BG	2CLA680200N3101	5

	Switch 1-gang, 2-way, SP half rocker 20AX Rated voltage: 250Vac Rated current: 20AX Half rocker size		
Stainless Steel	AMD11622-ST	2CLA680210N1101	10
Silk Black	AMD11622-SB	2CLA680210N1501	10
Antique Gold	AMD11622-AG	2CLA680210N1601	10
Matt Gold	AMD11622-MG	2CLA680210N1701	10
Dune Sand	AMD11622-DU	2CLA680210N6201	10
Mocha Brown	AMD11622-MO	2CLA680210N6601	10
White Glass	AMD11622-WG	2CLA680210N3001	5
Black Glass	AMD11622-BG	2CLA680210N3101	5

	Switch 1-gang, intermediate, SP half rocker 10AX Rated voltage: 250Vac Rated current: 10AX Half rocker size		
Stainless Steel	AMD12922-ST	2CLA681000N1101	10
Silk Black	AMD12922-SB	2CLA681000N1501	10
Antique Gold	AMD12922-AG	2CLA681000N1601	10
Matt Gold	AMD12922-MG	2CLA681000N1701	10
Dune Sand	AMD12922-DU	2CLA681000N6201	10
Mocha Brown	AMD12922-MO	2CLA681000N6601	10
White Glass	AMD12922-WG	2CLA681000N3001	5
Black Glass	AMD12922-BG	2CLA681000N3101	5

Millenium - Modular System (AMD)

Half/double rocker switches and push buttons

Product	Article-No.	Order-No.	Pack/Qty
	Switch 1-gang, 1-way, DP half rocker 20AX w/LED, Left-side Rated voltage: 250Vac Rated current: 20A Status indicator LED Half rocker size – Left-side rocker		
Stainless Steel	AMD11722-ST	2CLA680220N1101	10
Silk Black	AMD11722-SB	2CLA680220N1501	10
Antique Gold	AMD11722-AG	2CLA680220N1601	10
Matt Gold	AMD11722-MG	2CLA680220N1701	10
Dune Sand	AMD11722-DU	2CLA680220N6201	10
Mocha Brown	AMD11722-MO	2CLA680220N6601	10
White Glass	AMD11722-WG	2CLA680220N3001	5
Black Glass	AMD11722-BG	2CLA680220N3101	5

	Switch 1-gang, 1-way, DP half rocker 20AX w/LED, Right-side Rated voltage: 250Vac Rated current: 20A Status indicator LED Half rocker size – Right-side rocker		
Stainless Steel	AMD11822-ST	2CLA680230N1101	10
Silk Black	AMD11822-SB	2CLA680230N1501	10
Antique Gold	AMD11822-AG	2CLA680230N1601	10
Matt Gold	AMD11822-MG	2CLA680230N1701	10
Dune Sand	AMD11822-DU	2CLA680230N6201	10
Mocha Brown	AMD11822-MO	2CLA680230N6601	10
White Glass	AMD11822-WG	2CLA680230N3001	5
Black Glass	AMD11822-BG	2CLA680230N3101	5

Product	Article-No.	Order-No.	Pack/Qty
	Push button 1-gang, 1-way, SP half rocker 10A Rated voltage: 250Vac Rated current: 10A Half rocker size		
Stainless Steel	AMD43222-ST	2CLA680400N1101	10
Silk Black	AMD43222-SB	2CLA680400N1501	10
Antique Gold	AMD43222-AG	2CLA680400N1601	10
Matt Gold	AMD43222-MG	2CLA680400N1701	10
Dune Sand	AMD43222-DU	2CLA680400N6201	10
Mocha Brown	AMD43222-MO	2CLA680400N6601	10
White Glass	AMD43222-WG	2CLA680400N3001	5
Black Glass	AMD43222-BG	2CLA680400N3101	5

Millenium - Modular System (AMD)

Triple rocker switches and push buttons

Product	Article-No.	Order-No.	Pack/Qty
	Switch 3-gang, 2-way, triple rocker 10AX Rated voltage: 250Vac Rated power: 10AX Total		
Stainless Steel	AMD10753-ST	2CLA630200N1101	10
Silk Black	AMD10753-SB	2CLA630200N1501	10
Antique Gold	AMD10753-AG	2CLA630200N1601	10
Matt Gold	AMD10753-MG	2CLA630200N1701	10
Dune Sand	AMD10753-DU	2CLA630200N6201	10
Mocha Brown	AMD10753-MO	2CLA630200N6601	10
White Glass	AMD10753-WG	2CLA630200N3001	5
Black Glass	AMD10753-BG	2CLA630200N3101	5

	Switch 3-gang, 2-way, triple rocker 16AX Rated voltage: 250Vac Rated power: 16AX Total		
Stainless Steel	AMD12153-ST	2CLA630210N1101	10
Silk Black	AMD12153-SB	2CLA630210N1501	10
Antique Gold	AMD12153-AG	2CLA630210N1601	10
Matt Gold	AMD12153-MG	2CLA630210N1701	10
Dune Sand	AMD12153-DU	2CLA630210N6201	10
Mocha Brown	AMD12153-MO	2CLA630210N6601	10
White Glass	AMD12153-WG	2CLA630210N3001	5
Black Glass	AMD12153-BG	2CLA630210N3101	5

Product	Article-No.	Order-No.	Pack/Qty
	Push button 3-gang, 1-way, triple rocker 10AX Rated voltage: 250Vac Rated power: 10AX Total		
Stainless Steel	AMD43053-ST	2CLA630400N1101	10
Silk Black	AMD43053-SB	2CLA630400N1501	10
Antique Gold	AMD43053-AG	2CLA630400N1601	10
Matt Gold	AMD43053-MG	2CLA630400N1701	10
Dune Sand	AMD43053-DU	2CLA630400N6201	10
Mocha Brown	AMD43053-MO	2CLA630400N6601	10
White Glass	AMD43053-WG	2CLA630400N3001	5
Black Glass	AMD43053-BG	2CLA630400N3101	5

Millenium - Modular System (AMD)

Function | Dimmers

Product	Article-No.	Order-No.	Pack/Qty	
 <p>Universal rotary dimmer – 1M Rated voltage: 230 Vac ± 10% Frequency: 50-60Hz Power (min./max load): - LEDi (trailing-edge lamps), LV LEDi with transformer type C, LV halogen with transformer (type C or LC) and incandescent and halogen lamps: 4/250 W/VA. - LEDi (leading-edge lamps) and LV LEDi with transformer type LC: 4/60W/VA* * Max. 10 lamps Load selection 2 or 3 wire connection OFF position Electronic back-up fuse and overload protection Ambient temperature: 0° C to +35° C</p>	Anthracite P.	N2160.3 AP	2CLA216030B1001	1
	White	N2160.3 BL	2CLA216030B1101	1

Product	Article-No.	Order-No.	Pack/Qty	
 <p>Universal rotary dimmer – 2M Rated voltage: 230 Vac ± 10% Frequency: 50Hz (250W/VA) / 60Hz (200W/VA) Power (min./max load): - LEDi, dimmable CFL and LV LEDi with transformer (L or LC): 2/100W/VA* - Incandescent and halogen lamps: 10/250W/VA - LV halogen w/transformer (L or LC): 10/250W/VA* * max. 10 lamps 2 wire connection Optional: auxiliary on/off with 2-way switch N2X02 Indicator LED lamp included Electronic back-up fuse and overload protection Ambient temperature 0° C to +35° C</p>	Anthracite P.	N2260.3 AP	2CLA226030B1001	1
	White	N2260.3 BL	2CLA226030B1101	1

 <p>1-10V rotary dimmer - 2M Rated voltage: 127 - 230 Vac / 50-60Hz Dimmable electronic ballast/driver 1-10V control input. Max. power (max. 6 ballasts per device): 700 VA @ 230 Vac / 350 VA @ 127 Vac Indicator LED lamp included.</p>	Anthracite P.	N2260.9 AP	2CLA226090B1001	1
	White	N2260.9 BL	2CLA226090B1101	1

Millenium - Modular System (AMD)

Function | Socket outlets

Product	Article-No.	Order-No.	Pack/Qty
	Insert - Modular BS socket outlet Rated voltage: 250 Vac Rated current: 13A Type G: 2P + E Includes child safety shutter Frame AMD5144-XX & AMD5244-XX		
Anthracite P.	N2237 AP	2CLA223700B1001	10
White	N2237 BL	2CLA223700B1101	10

	Insert - Modular Schuko socket outlet Rated voltage: 250 Vac Rated current: 16A Type F: 2P + E Includes child safety shutter Frame AMD5144-XX & AMD5244-XX		
Anthracite P.	N2288 AP	2CLA228800B1001	10
White	N2288 BL	2CLA228800B1101	10

	Insert - Modular Universal socket outlet Rated voltage: 250 Vac / 125 Vac Rated current: 16A / 13A Multiple type: 2P + E Includes child safety shutter Frame AMD5144-XX & AMD5244-XX		
Anthracite P.	N2239 AP	2CLA223900B1001	10
White	N2239 BL	2CLA223900B1101	10

	Insert - Modular Euro-American socket outlet Rated voltage: 250 Vac / 125 Vac Rated current: 16A / 13A Type B+C: 2P / NEMA 5-15R Includes child safety shutter Frame AMD5144-XX & AMD5244-XX		
Anthracite P.	N2238 AP	2CLA223800B1001	10
White	N2238 BL	2CLA223800B1101	10

Product	Article-No.	Order-No.	Pack/Qty
	Insert - Modular Italian socket outlet Rated voltage: 250 Vac Rated current: 16A Type L: 2P + E / P17/11 Includes child safety shutter Frame AMD5144-XX & AMD5244-XX		
Anthracite P.	N2133 AP	2CLA213300B1001	20
White	N2133 BL	2CLA213300B1101	20

	Insert - Modular Euro-American socket outlet 22 x 44 Rated voltage: 250 Vac / 125 Vac Rated current: 16A / 15A Type B 2P / NEMA 5-15R Includes child safety shutter Frame AMD5144-XX & AMD5244-XX		
Anthracite P.	N2138 AP	2CLA213800B1001	20
White	N2138 BL	2CLA213800B1101	20

Millenium - Modular System (AMD)

Function | USB chargers

Product	Article-No.	Order-No.	Pack/Qty
 <p>USB charger Type A+C 18W 250 Vac / 50-60 Hz USB charger (Type C): Max. Power output: 18W Output voltage: 5 ... 9 Vdc. Output current: 3 ... 1.5 A.</p> <p>Charging Protocols: PD 3.0: Yes QC 4: Yes BC1.2: Yes MFI: Yes</p> <p>USB charger (Type A): Max Power output: 10.5 W Output voltage: 5 Vdc Output current: 2.1 A Frame AMD5144-XX & AMD5244-XX.</p>			
	Anthracite P.	N2285.1 AP	2CLA228510B1001
White	N2285.1 BL	2CLA228510B1101	1

 <p>USB charger Type-A 10W 250 Vac / 50-60 Hz</p> <p>USB charger (Type A): Max. Power output: 10.5W Output voltage: 5 Vdc Output current: 2.1 A</p> <p>Charging Protocols: PD 3.0: No QC 4: No BC1.2: Yes MFI: Yes</p> <p>Frame AMD5144-XX & AMD5244-XX</p>			
	Anthracite P.	N2185.2 AP	2CLA218520B1001
White	N2185.2 BL	2CLA218520B1101	1

Millenium - Modular System (AMD)

Function I TV/SAT outlets

Product	Article-No.	Order-No.	Pack/Qty
	TV terminal outlet M-type - 22 x 44 Single TV outlet - Dead-end M type - 9.52 mm male For 75Ω impedance coaxial cable Avoid small bending radius Frequency range: 5 - 2.400 Mhz Connection loss: 1 dB Isolation: >16 dB Return loss: >7,6 dB DC path (Vdc / mA / Tono): 34 max. / 500 max. / 22kHz-DiSEqC Frame AMD5144-XX & AMD5244-XX		
Anthracite P.	N2150.7 AP	2CLA215070B1001	10
White	N2150.7 BL	2CLA215070B1101	10

	TV terminal F-type screw-in 22 x 44 Single TV outlet F type - female For 75 Ω impedance coaxial cable Frequency range: 0 - 2.0 Working voltage: 250 VRMS max. 00 Mhz Dielectric withstanding voltage: 500 VRMS min. Frame AMD5144-XX & AMD5244-XX		
Anthracite P.	N2150 AP	2CLA215000B1001	10
White	N2150 BL	2CLA215000B1101	10

	TV outlet M-type + SAT F-Type dead-end 22 x 44 Single TV outlet - Dead end - TV: M type - 9.52 mm male - SAT: F type - female For 75 Ω impedance coaxial cable Frequency range (TV / SAT): 5 - 862 Mhz / 950 - 2.400 MHz Output loss (TV / SAT): 1dB/1dB Through loss (TV / SAT): 4dB/4dB DC path (Vdc / mA / Tono): 34 max. / 500 max. / 22kHz - DiSEqC. Frame AMD5144-XX & AMD5244-XX		
Anthracite P.	N2151.7 AP	2CLA215170B1001	10
White	N2151.7 BL	2CLA215170B1101	10

Product	Article-No.	Order-No.	Pack/Qty
	TV terminal M-type 44 x 44 Single TV outlet - Dead-end M type - 9.52 mm. male For 75Ω impedance coaxial cable Avoid small bending radius Frequency range: 5 - 2.400 Mhz Connection loss: 1 dB Isolation: >16 dB Return loss: >7,6 dB DC path (Vdc / mA / Tono): 34 max. / 500 max. / 22kHz- DiSEqC Frame AMD5144-XX & AMD5244-XX		
Anthracite P.	N2250.7 AP	2CLA225070B1001	10
White	N2250.7 BL	2CLA225070B1101	10

	TV/SAT outlet F-type screw-in 44 x 44 Single TV outlet F type - female For 75 Ω impedance coaxial cable Frequency range: 0 - 2.000 Mhz Working voltage: 250 VRMS max. Dielectric withstanding voltage: 500 VRMS min. Frame AMD5144-XX & AMD5244-XX		
Anthracite P.	N2250 AP	2CLA225000B1001	10
White	N2250 BL	2CLA225000B1101	10

	TV outlet M-type + SAT F-Type intermediate 22 x 44 Single TV outlet - intermediate - TV: M type - 9.52 mm male - SAT: F type - female For 75 Ω impedance coaxial cable Frequency range (TV / SAT): 5 - 862 Mhz / 950 - 2.400 MHz. Output loss (TV / SAT): 1 dB / 1 dB. DC path (Vdc / mA / Tono): 34 max. / 500 max. / 22kHz - DiSEqC.. Frame AMD5144-XX & AMD5244-XX		
Anthracite P.	N2151.7 AP	2CLA215180B1001	10
White	N2151.7 BL	2CLA215180B1101	10

Millenium - Modular System (AMD)

Function I Data and telephone outlets

Product	Article-No.	Order-No.	Pack/Qty
	Phone outlet RJ45 Cat6A 22 x 44 8 pole Cat 6A STP Frame AMD5144-XX & AMD5244-XX		
Anthracite P.	N2118.7 AP	2CLA211870B1001	10
White	N2118.7 BL	2CLA211870B1101	10

Product	Article-No.	Order-No.	Pack/Qty
	Phone outlet RJ45 Cat 6A 44 x 44 8 pole Cat 6A STP Frame AMD5144-XX & AMD5244-XX		
Anthracite P.	N2218.7 AP	2CLA221870B1001	10
White	N2218.7 BL	2CLA221870B1101	10

	Phone outlet RJ45 Cat6 22 x 44 Data outlet RJ45 Cat6 22 x 44 8 pole Cat 6 UTP Frame AMD5144-XX & AMD5244-XX		
Anthracite P.	N2118.6 AP	2CLA211860B1001	10
White	N2118.6 BL	2CLA211860B1101	10

	Phone outlet RJ45 Cat6 44 x 44 Data outlet RJ45 Cat6 44 x 44 8 pole Cat 6 UTP Frame AMD5144-XX & AMD5244-XX		
Anthracite P.	N2218.6 AP	2CLA221860B1001	10
White	N2218.6 BL	2CLA221860B1101	10

	Phone outlet RJ12 22 x 44 RJ12 type connection 6 contacts Frame AMD5144-XX & AMD5244-XX		
Anthracite P.	N2117.6 AP	2CLA211760B1001	10
White	N2117.6 BL	2CLA211760B1101	10

	Phone outlet RJ12 44 x 44 RJ12 type connection 6 contacts Frame AMD5144-XX & AMD5244-XX		
Anthracite P.	N2217.6 AP	2CLA221760B1001	10
White	N2217.6 BL	2CLA221760B1101	10

Millenium - Modular System (AMD)

Voice data & information connectors

Product	Article-No.	Order-No.	Pack/Qty
	Inclined cover plate with shutter for RJ45 connector 1-gang Cover plate for one data connector housing (refs.: AMD6016, AMD6016.1, AMD6016.2 and AMD6016.3) With labeling area for stickers With shutter Combination with frames: AMD5144-XX, AMD5244-XX, AMD5344-XX & AMD5444		
Anthracite P	AMD33544-AN	2CLA621670N1801	5
White	AMD33544-WP	2CLA621670N2001	5

	Inclined cover plate with shutter for RJ45 connector 2-gang Cover plate for two data connector housing (refs.: AMD6016, AMD6016.1, AMD6016.2 and AMD6016.3) With labeling area for stickers With shutter Combination with frames: AMD5144-XX, AMD5244-XX, AMD5344-XX & AMD5444		
Anthracite P	AMD33644-AN	2CLA621680N1801	5
White	AMD33644-WP	2CLA621680N2001	5

	Flat cover plate with shutter for RJ45 connector 1-gang Cover plate for one data connector housing (refs.: AMD6016, AMD6016.1, AMD6016.2 and AMD6016.3) With labeling area for stickers With shutter Combination with frames: AMD5144-XX, AMD5244-XX, AMD5344-XX & AMD5444		
Anthracite P	AMD33144-AN	2CLA621630N1801	10
White	AMD33144-WP	2CLA621630N2001	10

	Flat cover plate with shutter for RJ45 connector 2-gang Cover plate for two data connector housing (refs.: AMD6016, AMD6016.1, AMD6016.2 and AMD6016.3) With labeling area for stickers With shutter Combination with frames: AMD5144-XX, AMD5244-XX, AMD5344-XX & AMD5444		
Anthracite P	AMD33244-AN	2CLA621640N1801	10
White	AMD33244-WP	2CLA621640N2001	10

Product	Article-No.	Order-No.	Pack/Qty
	RJ45 Keystone, 3M & AMP system adaptor Combined with cover plates: AMD33144-XX, AMD33244-XX, AMD33544-XX & AMD33644-XX Combination with frames: AMD5144-XX, AMD5244-XX, AMD5344-XX & AMD5444		
	AMD6016	2CLA601600A1001	10

	RJ45 Systimax system adaptor Combined with cover plates: AMD33144-XX, AMD33244-XX, AMD33544-XX & AMD33644-XX Combination with frames: AMD5144-XX, AMD5244-XX, AMD5344-XX & AMD5444		
	AMD6016.1	2CLA601610A1001	10

	RJ45 Panduit system adaptor Combined with cover plates: AMD33144-XX, AMD33244-XX, AMD33544-XX & AMD33644-XX Combination with frames: AMD5144-XX, AMD5244-XX, AMD5344-XX & AMD5444		
	AMD6016.2	2CLA601620A1001	10

	RJ45 R&M system adaptor Combined with cover plates: AMD33144-XX, AMD33244-XX, AMD33544-XX & AMD33644-XX Combination with frames: AMD5144-XX, AMD5244-XX, AMD5344-XX & AMD5444		
	AMD6016.3	2CLA601630A1001	10

Millenium - Modular System (AMD)

Connectors, blank plates and bell function

Product	Article-No.	Order-No.	Pack/Qty
	2RCA connection unit Front: 2x RCA connectors (Red / White) Rear: screw terminals (4 wires) Combination with frames: AMD5144-XX, AMD5244-XX, AMD5344-XX & AMD5444-XX.		
Anthracite P	AMD55222-AN	2CLA615520N1801	1
White	AMD55222-WP	2CLA615520N2001	1

	3RCA connection unit Front: 3x RCA connectors (Red / White / Yellow) Rear: screw terminals (6 wires) Combination with frames: AMD5144-XX, AMD5244-XX, AMD5344-XX & AMD5444-XX.		
Anthracite P	AMD55322-AN	2CLA615530N1801	1
White	AMD55322-WP	2CLA615530N2001	1

	Mini-Jack connection unit Front: 1x Mini-Jack connector (3,5mm stereo audio jack) Rear: screw terminals (3/4 wires) Combination with frames: AMD5144-XX, AMD5244-XX, AMD5344-XX & AMD5444-XX.		
Anthracite P	AMD55422-AN	2CLA615540N1801	1
White	AMD55422-WP	2CLA615540N2001	1

	VGA connection unit Front: 1x VGA connector (DE-15 connector) Rear: screw terminals (15 wires) Combination with frames: AMD5144-XX, AMD5244-XX, AMD5344-XX & AMD5444-XX.		
Anthracite P	AMD55522-AN	2CLA615550N1801	1
White	AMD55522-WP	2CLA615550N2001	1

	HDMI connector female Front: 1x HDMI connector (Type A connector) Rear: 1x HDMI connector (Type A connector) fitted at 90° angle Combination with frames: AMD5144-XX, AMD5244-XX, AMD5344-XX & AMD5444-XX.		
Anthracite P	AMD55722-AN	2CLA615570N1801	5
White	AMD55722-WP	2CLA615570N2001	1

	USB connector female USB adaptor. No charger Front: 1x USB 2.0 connector (Type A connector) Rear: 1x USB 2.0 connector (Type A connector) fitted at 90° angle Combination with frames: AMD5144-XX, AMD5244-XX, AMD5344-XX & AMD5444-XX.		
Anthracite P	AMD55922-AN	2CLA615590N1801	1
White	AMD55922-WP	2CLA615590N2001	1

Product	Article-No.	Order-No.	Pack/Qty
	Blank cover plate - 1M Flat blank plate Frame AMD5144-XX & AMD5244-XX		
Anthracite P.	N2100 AP	2CLA210000B1001	1
White	N2100 BL	2CLA210000B1101	1

	Blank cover plate - 2M Flat blank plate Frame AMD5144-XX & AMD5244-XX		
Anthracite P.	N2200 AP	2CLA220000B1001	1
White	N2200 BL	2CLA220000B1101	1

	Buzzer - 2M Rated voltage: 127-230 Vac ; 50-60 Hz. Rated power: 8 VA. Adjustable tone. Acoustic power at 1 meter with cover plate: 75 dB. Combination with frames AMD5144-XX, AMD5244-XX, AMD5344-XX & AMD5444-XX.		
Anthracite P	AMD19144-AN	2CLA621900N1801	5
White	AMD19144-WP	2CLA621900N2001	5

	Electronic door bell 230Vac - 2M Rated voltage: 230 Vac ; 50-60 Hz. 4 melodies available. Acoustic power at 1 meter with cover plate: 72 dB. Combination with frames AMD5144-XX, AMD5244-XX, AMD5344-XX & AMD5444-XX.		
Anthracite P	AMD24144-AN	2CLA622400N1801	5
White	AMD24144-WP	2CLA622400N2001	5

Millenium - Modular System (AMD)

Function | Hospitality

Product	Article-No.	Order-No.	Pack/Qty
	Push button 2-gang, DND/MUR with bell symbol 10A Rated voltage: 250Vac Rated power: 10A "Do Not Disturb" "Make Up my Room" LED signalling		
Stainless Steel	AMD40344-ST	2CLA621580N1101	5
Silk Black	AMD40344-SB	2CLA621580N1501	5
Antique Gold	AMD40344-AG	2CLA621580N1601	5
Matt Gold	AMD40344-MG	2CLA621580N1701	5
Dune Sand	AMD40344-DU	2CLA621580N6201	5
Mocha Brown	AMD40344-MO	2CLA621580N6601	5
White Glass	AMD40344-WG	2CLA621580N3001	5
Black Glass	AMD40344-BG	2CLA621580N3101	5

	Switch 2-gang, DND/MUR 10AX Rated voltage: 250Vac Rated power: 10AX "Do Not Disturb" "Make Up my Room" LED signalling		
Stainless Steel	AMD40444-ST	2CLA621500N1101	5
Silk Black	AMD40444-SB	2CLA621500N1501	5
Antique Gold	AMD40444-AG	2CLA621500N1601	5
Matt Gold	AMD40444-MG	2CLA621500N1701	5
Dune Sand	AMD40444-DU	2CLA621500N6201	5
Mocha Brown	AMD40444-MO	2CLA621500N6601	5
White Glass	AMD40444-WG	2CLA621500N3001	5
Black Glass	AMD40444-BG	2CLA621500N3101	5

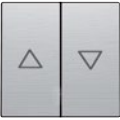
	Switch blind control Rated voltage: 250Vac Rated power: 16AX Output: 2 normally open contact Multi-way input terminal (up/down)		
Stainless Steel	AMD11844-ST	2CLA624410N1101	10
Silk Black	AMD11844-SB	2CLA624410N1501	10
Antique Gold	AMD11844-AG	2CLA624410N1601	10
Matt Gold	AMD11844-MG	2CLA624410N1701	10
Dune Sand	AMD11844-DU	2CLA624410N6201	10
Mocha Brown	AMD11844-MO	2CLA624410N6601	10
White Glass	AMD11844-WG	2CLA624410N3001	5
Black Glass	AMD11844-BG	2CLA624410N3101	5

Product	Article-No.	Order-No.	Pack/Qty
	Card switch 16AX Rated voltage: 250 Vac Rated current: 16AX Max. power: iLED 200W. Includes LED indicator Function size: 44 x 44 mm Frame AMD5144-XX & AMD5244-XX.		
Anthracite P.	N2214.1 AP	2CLA221410B1001	10
White	N2214.1 BL	2CLA221410B1101	10

	Electronic Card switch 16AX w/timer Rated voltage: 250 Vac Rated current: 16AX Max. power: iLED200W / Traditional: 1600W Includes LED indicator Adjustable time-out: 5-90 seg. Function size: 44 x 44 mm Frame AMD5144-XX & AMD5244-XX.		
Anthracite P.	N2214.5 AP	2CLA221450B1001	1
White	N2214.5 BL	2CLA221450B1101	1

	Electronic Card switch 16AX w/RFID 250 Vac 50-60 HN. / 16A Rated voltage: 110 230 V AC, ±10 %, RFID card-only option:Yes 4 programming modes: ECO, STANDARD, EXTENDED, CUSTOM Status backlight: Yes Dim-out deactivation: Yes Adjustable time-out: 0-240 seg. Output: 2*NO cotact Electronic relay: Yes Load compatibility (min. / max load): -LEDi: 250 W/VA. -LV LEDi with transformer type C: 4 / 250 W/VA. -LV LEDi with transformer type LC: 4 / 60 W/VA.* -LV halogen with transformer type C: 4 / 250 W/VA. -LV halogen with transformer type LC: 4 / 250 W/VA. -Incandescent lamps: 4 / 250 W/VA. -Halogen lamps: 4 / 250 W / VA. -Blind control (M-type) max. 2 A rame AMD5144-XX & AMD5244-XX.		
Anthracite P.	N2214.6 AP	2CLA221460B1001	1
White	N2214.6 BL	2CLA221460B1101	1

Millenium - Modular system

Function | Microswitches

Product	Article-No.	Order-No.	Pack/Qty
---------	-------------	-----------	----------



Microswitch 1/2 channels - 2M
 Binary input for SELV systems
 Rated voltage: 5-24 Vac or Vdc
 Max. current: 50 mA (per switch)
 Included: 2 indicator LED lamps
 Function size: 44 x 44 mm

White	N2205.1 BL	2CLA220510N1101	1
Silver	N2205.1 PL	2CLA220510N1301	1
Anthracite	N2205.1 AN	2CLA220510N1801	1
Champagne	N2205.1 CV	2CLA220510N1901	1



Microswitch 2/4 channels - 2M
 Binary input for SELV systems
 Rated voltage: 5-24 Vac or Vdc
 Max. current: 50 mA (per switch)
 Included: 4 indicator LED lamps
 Function size: 44 x 44 mm

White	N2205.2 BL	2CLA220520N1101	1
Silver	N2205.2 PL	2CLA220520N1301	1
Anthracite	N2205.2 AN	2CLA220520N1801	1
Champagne	N2205.2 CV	2CLA220520N1901	1



Microswitch 3/6 channels - 2M
 Binary input for SELV systems
 Rated voltage: 5-24 Vac or Vdc
 Max. current: 50 mA (per switch)
 Included: 6 indicator LED lamps
 Function size: 44 x 44 mm

White	N2205.3 BL	2CLA220530N1101	1
Silver	N2205.3 PL	2CLA220530N1301	1
Anthracite	N2205.3 AN	2CLA220530N1801	1
Champagne	N2205.3 CV	2CLA220530N1901	1

Millenium - Modular system

Function | Room Temperature Controllers

Product	Article-No.	Order-No.	Pack/Qty
---------	-------------	-----------	----------



ON/OFF Room Temperature Controller
 For triggering the ventilation and fan-coil actuators in ON/OFF type installations.
 Thermostat for fan-coil units in 2 pipes systems.
 Display elements: LCD showing four operation modes: Cooling/Fan only/Energy saving/Sleep
 Selected models can use Modbus RS485 protocol.

Rated voltage: 110-250 Vac / 50-60 Hz
 Load capacity: Resistive: 4 A; Inductive: 2 A
 Output voltage: 230 Vac
 Temperature sensor: internal NTC
 Temperature Setting Range 5-35°C (0.5°C sensitivity)
 Temperature accuracy: +/- 1°C
 Installation box: 86 x 86 x 47 mm (BS type)

Standard models:

White	BR417	2TCZ204001R0010	1
Black	BR417-885	2TCZ204001R4410	1

Modbus RS485 option models:

White	BR432	2TCZ204003R0010	1
Black	BR432-885	2TCZ204003R4410	1

Product	Article-No.	Order-No.	Pack/Qty
---------	-------------	-----------	----------



0-10Vdc Modulating Room Temperature Controller
 For triggering the ventilation and fan-coil actuators in modulating 0-10Vdc valve installations.
 Thermostat for fan-coil units in 2 pipe systems.
 Display elements: LCD showing four operation modes: Cooling/Fan only/Energy saving/Sleep
 Selected models can use Modbus RS485 protocol.

Rated voltage: 24 Vac / 50-60 Hz
 Load capacity: Resistive: 4 A; Inductive: 2 A
 Output voltage: 0-10 Vdc (valve), 230 Vac (fan)
 Temperature sensor: internal NTC
 Temperature Setting Range 5-35°C (0.5°C sensitivity)
 Temperature accuracy: +/- 1°C
 Installation box 86 x 86 x 47 mm (BS type)

Standard models:

White	BR483	2TCZ204002R0010	1
Black	BR483 -885	2TCZ204002R4410	1

Modbus RS485 option models:

White	BR484	2TCZ204004R0010	1
Black	BR484 -885	2TCZ204004R4410	1

Millenium - Modular System (AMD)

Sound system

Product	Article-No.	Order-No.	Pack/Qty
	Modular sound system, BT receiver with amplifier Rated voltage: 110-230 Vac \pm 15%; 50-60 Hz Max. consumption: 7W Stand-by consumption: 0,2W Amplifier power: 2+2 W; <1% distortion (16 Ω) Speaker impedance: 16 Ω (2+2 W audio) 3 audio inputs: Bluetooth, AUX (front), TV (rear)		
Anthracite P	AMD68444-AN	2CLA626840N1801	1
White	AMD68444-WP	2CLA626840N2001	1

	FM stereo receiver with RDS Rated voltage: 230 Vac \pm 15% / 50-60 Hz Max. consumption:100 mA Stand-by consumption with the display illumination at minimum:0.2 W Stand-by consumption ref. AMD68044-AN + AMD68344-AN9368: 0.6 W Maximum output power: 2+2 W; <1% distortion (16 W) Speaker Impedance: 16 W (2+2 W audio) Combination with frames AMD5144-XX, AMD5244-XX, AMD5344-XX & AMD5444-XX.		
Anthracite P	AMD68044-AN	2CLA626800N1801	1
White	AMD68044-WP	2CLA626800N2001	1

	Input/output, USB & Bluetooth® module Power supply through AUX.: 9 V Bluetooth® v2.1 2.4GHz IEEE 802.15.1 Maximum reach from the module to user's Bluetooth® device: 10 m. Maximum consumption: 175 ~ 200 mA Consumption stand-by: 0.4 W Headphones impedance: 16 ~ 600 Ω (25 + 25 mW audio phones) Combination with frames AMD5144-XX, AMD5244-XX, AMD5344-XX & AMD5444-XX.		
Anthracite P	AMD68344-AN	2CLA626830N1801	1
White	AMD68344-WP	2CLA626830N2001	1

	Remote control unit for 9368.1 Power supply: 230 V~ / 127 V~ ; \pm 15% ; 50-60 Hz Maximum power consumption ref. 9368.2: 15 mA Stand-by consumption with the display illumination at minimum :0.5 W Stand-by consumption ref. AMD68244-AN + AMD68344-AN: 0.9 W Combination with frames AMD5144-XX, AMD5244-XX, AMD5344-XX & AMD5444-XX.		
Anthracite P	AMD68244-AN	2CLA626820N1801	1
White	AMD68244-WP	2CLA626820N2001	1

Product	Article-No.	Order-No.	Pack/Qty
	Radio/amplifier module for ceiling with Bluetooth® 9368.1 Bluetooth®: 230 V~ / 127 V~; \pm 15%; 50-60 Hz Maximum reach from the module to user's Bluetooth® device: 10 m. Maximum power consumption: 200 mA Consumption stand-by: 0.3 W Antenna impedance: 75 Ω Maximum power headphone output: 6+6 W; <1% distortion (4 Ω) Minimum impedance of headphones: 4 Ω (6+6 W audio)		
	9368.1	2CLA936810A1002	10

	Loudspeaker 5" Installation in flush box ref. 9399 drilling 17mm or embedded ring ref. 9399.1 drilling 160mm. Max. Power: 6W Impedance: 16 Ω Response frequency: 70Hz to 10kHz		
	9329.1	2CLA932910A1001	1

	Flush box for loudspeaker 5"		
	9399	2CLA939900A1001	12

	Embedded ring for loudspeaker 5"		
	9399.1	2CLA939910A1001	12

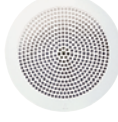
	Styling grid for loudspeaker 5"		
	9399.2	2CLA939920A1001	12

Millenium - Modular System (AMD)

ABB-free@home®

Product	Article-No.	Order-No.	Pack/Qty
	For switching 230 V~ consumers. With integrated switch actuator. Switching function is available also without prior programming (pre-configured). Only to be used in combination with ABB-free@home® 1/2-Fold sensor cover plate. 44 mm. × 44 mm. × 45 mm. Outputs: 1× normally open contact, potential free. Suitable for: ohmic. Rated current: 10 A. Rated power: 2300 W. Suitable for: capacitive. Rated current: 10 AX. Protection class of device: IP 20. Mounting depth: 32 mm.		
	SSA-F-1.1.PB.1	2CKA006220A0232	1
Wireless	SSA-F-1.1.PB.1-WL	2CKA006200A0108	1

	For dimming 230 V~ loads. With integrated universal dimming actuator for controlling different lamps. The dimming function is available also without prior programming (pre-configured). Only to be used in combination with ABB-free@home® 1/2-Fold sensor cover plate. 44 mm. × 44 mm. × 45 mm. Outputs: 1× dimming channel. Suitable for: 230 V incandescent lamps and low-voltage halogen lamps with conventional transformers or electronic transformers. Rated power: 10 – 180 W / VA. Suitable for: LEDi and energy-saving bulbs; typical. Rated power: 2 – 80 W / VA. Protection class of device: IP 20. Mounting depth: 32 mm.		
	SDA-F-1.1.PB.1	2CKA006220A0235	1
Wireless	SDA-F-1.1.PB.1-WL	2CKA006200A0111	1

	For controlling blind and awning motors. With integrated blind actuator. Blind function is available also without prior programming (pre-configured). Only to be used in combination with ABB-free@home® 1/2-Fold sensor cover plate. 44 mm. × 44 mm. × 45 mm. Outputs: 1× Change-over contacts/ normally open contact, potential bound. Rated power: 920 VA. Rated current: 4 A. Suitable for: Operating mode blind. Protection class of device: IP 20. Mounting depth: 32 mm.		
	SBA-F-1.1.PB.1	2CKA006220A0237	1
Wireless	SBA-F-1.1.PB.1-WL	2CKA006200A0113	1

Product	Article-No.	Order-No.	Pack/Qty
	For sending switching, dimming and blind commands to an ABB-free@home® actuator. Only to be used in combination with ABB-free@home® 1/2-Fold sensor cover plate. 44 mm. × 44 mm. × 45 mm. Control: Push buttons up/down. LEDS: Used as orientation light or as switching status. Protection class of device: IP 20. Mounting depth: 9 mm.		
	SU-F-1.0.PB.1	2CKA006220A0222	1
Wireless	SU-F-1.0.PB.1-WL	2CKA006200A0106	1

	1/2-Fold sensor cover plate Cover plate ABB-free@home® 1/2-Fold sensor for the SSA-F-1.1.PB.1, SDAF-1.1.PB.1, SBA-F-1.1.PB.1 and SU-F-1.0.PB.1 sensors. Combination with frames AMD5144-XX, AMD5244-XX, AMD5344-XX & AMD5444-XX.		
Anthracite P	SR-2-AMAN	2CLA622620N1801	5
White	SR-2-AMWP	2CLA622620N2001	5

	For switching 230 V~ consumers. With one integrated switch actuator. Switching function is available also without prior programming (pre-configured). Only to be used in combination with ABB-free@home® 2/4-Fold sensor cover plate. 44 mm. × 44 mm. × 45 mm. Outputs: 1× normally open contact, potential free. Suitable for: ohmic. Rated current: 10 A. Rated power: 2300 W. Suitable for: capacitive. Rated current: 10 AX. Protection class of device: IP 20. Mounting depth: 32 mm.		
	SSA-F-2.1.PB.1	2CKA006220A0233	1
Wireless	SSA-F-2.1.PB.1-WL	2CKA006200A0109	1

	For switching 230 V~ consumers. With two integrated switch actuators. Switching function is available also without prior programming (pre-configured). Only to be used in combination with ABB-free@home® 2/4-Fold sensor cover plate. 44 mm. × 44 mm. × 45 mm. Outputs: 2× normally open contact, potential free. Suitable for: ohmic. Rated current: 10 A. Rated power: 2300 W. Suitable for: capacitive. Rated current: 10 AX. Protection class of device: IP 20. Mounting depth: 32 mm.		
	SSA-F-2.2.PB.1	2CKA006220A0234	1
Wireless	SSA-F-2.2.PB.1-WL	2CKA006200A0110	1

Millenium - Modular System (AMD)

ABB-free@home®

Product	Article-No.	Order-No.	Pack/Qty
	For dimming 230 V~ loads. With integrated universal dimming actuator for controlling different lamps. The dimming function is available also without prior programming (pre-configured). Only to be used in combination with ABB-free@home® 2/4-Fold sensor cover plate. 44 mm. × 44 mm. × 45 mm. Outputs: 1× dimming channel. Suitable for: 230 V incandescent lamps and low-voltage halogen lamps with conventional transformers or electronic transformers. Rated power: 10 – 180 W / VA. Suitable for: LEDi and energy-saving bulbs; typical. Rated power: 2 – 80 W / VA Protection class of device: IP 20. Mounting depth: 32 mm.		
	SDA-F-2.1.PB.1	2CKA006220A0236	1
Wireless	SDA-F-2.1.PB.1-WL	2CKA006200A0112	1

	For controlling blind and awning motors. With integrated blind actuator. Blind function is available also without prior programming (pre-configured). Only to be used in combination with ABB-free@home® 2/4-Fold sensor cover plate. 44 mm. × 44 mm. × 45 mm. Outputs: 1× Change-over contacts/ normally open contact, potentialbound. Rated power: 920 VA. Rated current: 4 A. Suitable for: Operating mode blind. Protection class of device: IP 20. Mounting depth: 32 mm.		
	SBA-F-2.1.PB.1	2CKA006220A0238	1
Wireless	SBA-F-2.1.PB.1-WL	2CKA006200A0114	1

	For sending switching, dimming and blind commands to an ABB-free@home® actuator. Only to be used in combination with ABB-free@home® 2/4-Fold sensor cover plate. 44 mm. × 44 mm. × 45 mm. Control: Push buttons up/down. LEDs: Used as orientation light or as switching status. Protection class of device: IP 20. Mounting depth: 9 mm.		
	SU-F-2.0.PB.1	2CKA006220A0223	1
Wireless	SU-F-2.0.PB.1-WL	2CKA006200A0107	1

	2/4-Fold sensor cover plate Cover plate ABB-free@home® 2/4-Fold sensor for the SSA-F-2.1.PB.1, SSA-F-2.2.PB.1, SDA-F-2.1.PB.1, SBA-F-2.1PB.1 and SU-F-2.0.PB.1 sensors. Combination with frames AMD5144-XX, AMD5244-XX, AMD5344-XX & AMD5444-XX.		
Anthracite P	SR-4-AMAN	2CLA622640N1801	5
White	SR-4-AMWP	2CLA622640N2001	5

Product	Article-No.	Order-No.	Pack/Qty
	For controlling the room temperature with thermostat functions. Control of conventional actuators or analog actuator (constant regulation) with the HA-M-0.6.1 and HA-M-0.12.1 actuators. With NOMINAL temperature indication. Only to be used in combination with ABB-free@home® room temperature controller cover plate. 44 mm. × 44 mm. × 45 mm. Visualization: LCD status mode indicator. Protection class of device: IP 20. Mounting depth: 14 mm.		
	RTC-F-1.PB	2CKA006220A0276	1
Wireless	RTC-F-1.PB-WL	2CKA006200A0115	1

	Room temperature controller cover plate. Cover plate ABB-free@home® for RTC-F-1.PB		
Anthracite P	CP-RTC-AMAN	2CLA624060N1801	5
White	CP-RTC-AMWP	2CLA624060N2001	5





	Watchdog sensor 180° with lens for the detection of animals. For the automatic switching of the ABB-free@home® actuators. Only to be used in combination with ABB-free@home® Watchdog 180° flush mounted cover plate. 44 mm. × 44 mm. × 45 mm. Detection range: 6m front, 3m lateral. Angle: 180°. Brightness range: 1-500 Lux. Protection class of device: IP 20. Mounting depth: 9 mm.		
	MSA-F-1.1.PB.1	2CKA006220A0231	1
Wireless	MSA-F-1.1.PB.1 -WL	2CKA006200A0117	1

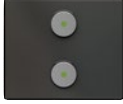

	Watchdog sensor 180 cover plate. Cover plate ABB-free@home® for Watchdog sensor MSA-F-1.1.PB.1. Combination with frames AMD5144-XX, AMD5244-XX, AMD5344-XX & AMD5444-XX.		
Anthracite P	CP-MD-AMAN	2CLA624160N1801	5
White	CP-MD-AMWP	2CLA624160N2001	5

	Light symbol button ABB-free@home® Blind symbol button ABB-free@home® Scene symbol button ABB-free@home® Dimmer symbol button ABB-free@home®		
Light Anthracite P	SBL-AMAN	2CLA602610N1801	20
Light White	SBL-AMWP	2CLA602610N2001	20
Blind Anthracite P	SBB-AMAN	2CLA602620N1801	20
Blind White	SBB-AMWP	2CLA602620N2001	20
Scene Anthracite P	SBS-AMAN	2CLA602630N1801	20
Scene White	SBS-AMWP	2CLA602630N2001	20
Dimmer Anthracite P	SBD-AMAN	2CLA602640N1801	20
Dimmer White	SBD-AMWP	2CLA602640N2001	20

Millenium - Modular System (AMD)

KNX system

Product	Article-No.	Order-No.	Pack/Qty
 <p>2-Fold sensor Incl. 10 logic channels (light scene actuator, sequence actuator, logic gates, etc.). Control element: Switch contacts. Display elements: LED to indicate the function. Protection class (Device): IP 20. Temperature range (Device): -5 °C to 45 °C. Combine with frame AMD5153-XX and AMD5253-XX.</p>	AMD72053-AN (6125/20-981-500)	2CKA006115A0443	1
	AMD72053-WP (6125/20-214-500)	2CKA006115A0500	1
 <p>4-Fold sensor Incl. 10 logic channels (light scene actuator, sequence actuator, logic gates, etc.). Control element: Switch contacts. Display elements: LED to indicate the function. Protection class (Device): IP 20. Temperature range (Device): -5 °C to 45 °C. Combine with frame AMD5153-XX and AMD5253-XX.</p>	AMD74053-AN (6126/20-981-500)	2CKA006116A0218	1
	AMD74053-WP (6126/20-214-500)	2CKA006115A0501	1
 <p>6-Fold sensor Incl. 10 logic channels (light scene actuator, sequence actuator, logic gates, etc.). Control element: Switch contacts. Display elements: LED to indicate the function. Protection class (Device): IP 20. Temperature range (Device): -5 °C to 45 °C. Combine with frame AMD5153-XX and AMD5253-XX.</p>	AMD76053-AN (6129/20-981-500)	2CKA006118A0104	1
	AMD76053-WP (6129/20-214-500)	2CKA006115A0502	1
 <p>6-Fold sensor with IR Incl. 10 logic channels (light scene actuator, sequence actuator, logic gates, etc.). Control element: Switch contacts. Display elements: LED to indicate the function. Protection class (Device): IP 20. Temperature range (Device): -5 °C to 45 °C. Combine with frame AMD5153-XX and AMD5253-XX.</p>	AMD76153-AN (6129/21-981-500)	2CKA006118A0107	1
	AMD76153-WP (6129/21-214-500)	2CKA006134A0355	1
 <p>Watchdog 180° flush mounted Movement sensor with up to four channels. Detection range: frontal: 6 m., lateral: 6 m. Detection angle: 180 °. Brightness limit value: 5 Lux - 150 Lux. Mounting height: 1.1 m. Protection class (Device): IP 20. Temperature range (Device): -5 °C to 45 °C. Combine with frame AMD5153-XX and AMD5253-XX. Position for installation: vertical.</p>	AMD70153-AN (6122/20-981-500)	2CKA006132A0306	1
	AMD70153-WP (6122/20-214-500)	2CKA006132A0424	1

Product	Article-No.	Order-No.	Pack/Qty
 <p>Room thermostat heating/cooling fan coil Control element with room thermostat function for triggering the heating, ventilation and fan-coil actuators. The controller is a thermostat for fan coil units in 2- and 4-pipe systems and conventional heating or cooling systems. The fan stage can be switched manually or in automatic mode. Incl. 10 logic channels (light scene actuator, sequence actuator, logic gates, etc.). Switch contacts for operating mode selection and dial for setpoint or fan speed adjustment. Display elements: LCD showing operation modes. Protection class (Device): IP 20. Temperature range (Device): -5 °C to 45 °C. Combine with frame AMD5153-XX and AMD5253-XX.</p>	AMD70053-AN (6124/08-981-500)	2CKA006134A0309	1
	AMD70053-WP (6124/08-214-500)	2CKA006134A0354	1
 <p>Ceiling light symbol Blind symbol Scene symbol Temperature symbol Light symbol Fan coil symbol Labelling insert for Millenium control covers 1 / 2-gang, 2 / 4-gang, 3 / 6-gang and 3 / 6-gang with infrared</p>	AM50701-GR (6123/20-500)	2CKA006123A0001	10
	AM50702-GR (6123/21-500)	2CKA006123A0002	10
AM50703-GR (6123/22-500)	2CKA006123A0003	10	
AM50704-GR (6123/23-500)	2CKA006123A0004	10	
AM50705-GR (6123/24-500)	2CKA006123A0005	10	
AM50706-GR (6123/26-500)	2CKA006123A0006	10	
AM50701-WH (6123/20-214-500)	2CKA006123A0007	10	
AM50702-WH (6123/21-214-500)	2CKA006123A0008	10	
AM50703-WH (6123/22-214-500)	2CKA006123A0009	10	
AM50704-WH (6123/23-214-500)	2CKA006123A0010	10	
AM50705-WH (6123/24-214-500)	2CKA006123A0011	10	
AM50706-WH (6123/26-214-500)	2CKA006123A0012	10	

Millenium - Modular System (AMD)

Access control KNX

Product	Article-No.	Order-No.	Pack/Qty
	Mifare transponder reader 1) Access Control transponder reader able to be completely integrated into every KNX installation. 2) 1 binary input for connecting cardholder 3) 1 output 4A (24 V AC/DC) Required additional power supply (10...32 V DC/12...24 V AC) Combination with frames AMD5144-XX, AMD5244-XX, AMD5344-XX & AMD5444-XX.		
TR/U 1.1		2CSY235683R2001	1

	Mifare transponder holder Access Control transponder holder able to be completely integrated into every KNX installation. 1) 1 binary input (ON/OFF, dimmer, shutter) 2) 1 output 4A (24 V AC/DC) Required additional power supply (12...24 V AC/DC) Combination with frames AMD5144-XX, AMD5244-XX, AMD5344-XX & AMD5444-XX.		
TH/U 1.1		2CSY265232R2021	1

	Set of 10 transponder cards The transponder card uses passive transponder technology operating in radio frequency (MIFARE technology), without the need for contact between the reader and the card itself. The transponder card is read by swiping it in front of the reader at a maximum distance of 20 mm (can be reduced according to installation environment).		
TS/T 1		2CSY259412R2041	1

Product	Article-No.	Order-No.	Pack/Qty
	Software MiniMAC 4.1 Configuration and supervision software for ABB Access Control system. Main functionalities are: management of keys, room state monitoring. Guest check in/check out, front desk room load monitoring, management of guest and employee databases, front desk management of room climate, ...		
SW MiniMAC 4.1		2CSY258202R2051	1

Millenium - Modular System (AMD)

Frames including metal support

Product	Article-No.	Order-No.	Pack/Qty
	Frame 1-gang – Window 44 x 44 -Single Frame dimensions: 86 x 86 mm Window size: 44 x 44 mm Includes metal support and screws Extra robustness for Premium switches (single function only)		
Stainless Steel	AMD5044-ST	2CLA617110N1101	10
Silk Black	AMD5044-SB	2CLA617110N1501	10
Antique Gold	AMD5044-AG	2CLA617110N1601	10
Matt Gold	AMD5044-MG	2CLA617110N1701	10
Dune Sand	AMD5044-DU	2CLA617110N6201	10
Mocha Brown	AMD5044-MO	2CLA617110N6601	10
White Glass	AMD5044-WG	2CLA617110N3001	4
Black Glass	AMD5044-BG	2CLA617110N3101	4

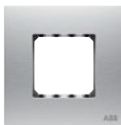
	Frame 1-gang – Window 44 x 44 –Multifunction Frame dimensions: 86 x 86 mm Window size: 44 x 44 mm Includes metal support and screws For multiple function configurations		
Stainless Steel	AMD5144-ST	2CLA627100N1101	10
Silk Black	AMD5144-SB	2CLA627100N1501	10
Antique Gold	AMD5144-AG	2CLA627100N1601	10
Matt Gold	AMD5144-MG	2CLA627100N1701	10
Dune Sand	AMD5144-DU	2CLA627100N6201	10
Mocha Brown	AMD5144-MO	2CLA627100N6601	10
White Glass	AMD5144-WG	2CLA627100N3001	10
Black Glass	AMD5144-BG	2CLA627100N3101	10

	Frame 2-gang – Window 44 x 44 – Multifunction Frame dimensions: 147 x 86 mm Window size: 2*44 x 44 mm Includes metal support and screws For multiple function configurations		
Stainless Steel	AMD5244-ST	2CLA647200N1101	10
Silk Black	AMD5244-SB	2CLA647200N1501	10
Antique Gold	AMD5244-AG	2CLA647200N1601	10
Matt Gold	AMD5244-MG	2CLA647200N1701	10
Dune Sand	AMD5244-DU	2CLA647200N6201	10
Mocha Brown	AMD5244-MO	2CLA647200N6601	10
White Glass	AMD5244-WG	2CLA647200N3001	5
Black Glass	AMD5244-BG	2CLA647200N3101	5

Product	Article-No.	Order-No.	Pack/Qty
	Frame 3-gang –Window 44 x 44 – Multifunction Frame dimensions: 228 x 86 mm Window size: 3*44 x 44 mm Includes metal support and screws For multiple function configurations Compatible with box model: 1099		
Stainless Steel	AMD5344-ST	2CLA667310N1101	5
Silk Black	AMD5344-SB	2CLA667310N1501	5
Antique Gold	AMD5344-AG	2CLA667310N1601	5
Matt Gold	AMD5344-MG	2CLA667310N1701	5
Dune Sand	AMD5344-DU	2CLA667310N6201	5
Mocha Brown	AMD5344-MO	2CLA667310N6601	5
White Glass	AMD5344-WG	2CLA667310N3001	2
Black Glass	AMD5344-BG	2CLA667310N3101	2

	Frame 4-gang – Window 44 x 44 – Multifunction Frame dimensions: 293 x 86 mm Window size: 4*44 x 44 mm Includes metal support and screws For multiple function configurations Compatible with box model: 1099		
Stainless Steel	AMD5444-ST	2CLA687410N1101	5
Silk Black	AMD5444-SB	2CLA687410N1501	5
Antique Gold	AMD5444-AG	2CLA687410N1601	5
Matt Gold	AMD5444-MG	2CLA687410N1701	5
Dune Sand	AMD5444-DU	2CLA687410N6201	5
Mocha Brown	AMD5444-MO	2CLA687410N6601	5
White Glass	AMD5444-WG	2CLA687410N3001	2
Black Glass	AMD5444-BG	2CLA687410N3101	2

Millenium - Modular System (AMD)

Frames including metal support

Product	Article-No.	Order-No.	Pack/Qty
	Frame 1-gang – Window 21 x 32 -Single Frame dimensions: 86 x 86 mm Window size: 21 x 32 mm Includes metal support and screws Extra robustness for Small switches (single function only)		
Stainless Steel	AMD5120-ST	2CLA617100N1101	10
Silk Black	AMD5120-SB	2CLA617100N1501	10
Antique Gold	AMD5120-AG	2CLA617100N1601	10
Matt Gold	AMD5120-MG	2CLA617100N1701	10
Dune Sand	AMD5120-DU	2CLA617100N6201	10
Mocha Brown	AMD5120-MO	2CLA617100N6601	10
White Glass	AMD5120-WG	2CLA617100N3001	4
Black Glass	AMD5120-BG	2CLA617100N3101	4

Product	Article-No.	Order-No.	Pack/Qty
	Frame 1-gang – Window 53 x 44 Frame dimensions: 86 x 86 mm Window size: 53 x 44 mm Includes metal support and screws For Triple rocker switches		
Stainless Steel	AMD5153-ST	2CLA637100N1101	10
Silk Black	AMD5153-SB	2CLA637100N1501	10
Antique Gold	AMD5153-AG	2CLA637100N1601	10
Matt Gold	AMD5153-MG	2CLA637100N1701	10
Dune Sand	AMD5153-DU	2CLA637100N6201	10
Mocha Brown	AMD5153-MO	2CLA637100N6601	10
White Glass	AMD5153-WG	2CLA637100N3001	10
Black Glass	AMD5153-BG	2CLA637100N3101	10

	Frame 2-gang – Window 53 x 44 Frame dimensions: 147 x 86 mm Window size: 2*53 x 44 mm Includes metal support and screws For Triple rocker switches		
Stainless Steel	AMD5253-ST	2CLA667200N1101	10
Silk Black	AMD5253-SB	2CLA667200N1501	10
Antique Gold	AMD5253-AG	2CLA667200N1601	10
Matt Gold	AMD5253-MG	2CLA667200N1701	10
Dune Sand	AMD5253-DU	2CLA667200N6201	10
Mocha Brown	AMD5253-MO	2CLA667200N6601	10
White Glass	AMD5253-WG	2CLA667200N3001	5
Black Glass	AMD5253-BG	2CLA667200N3101	5

Diagrams, technical data and measurements

All of the information at your disposal

Thinking of making your job easier. We create these supports to optimize your time. We offer you all the technical information, diagrams and dimensions of each of our products in a clear and precise manner to facilitate understanding.

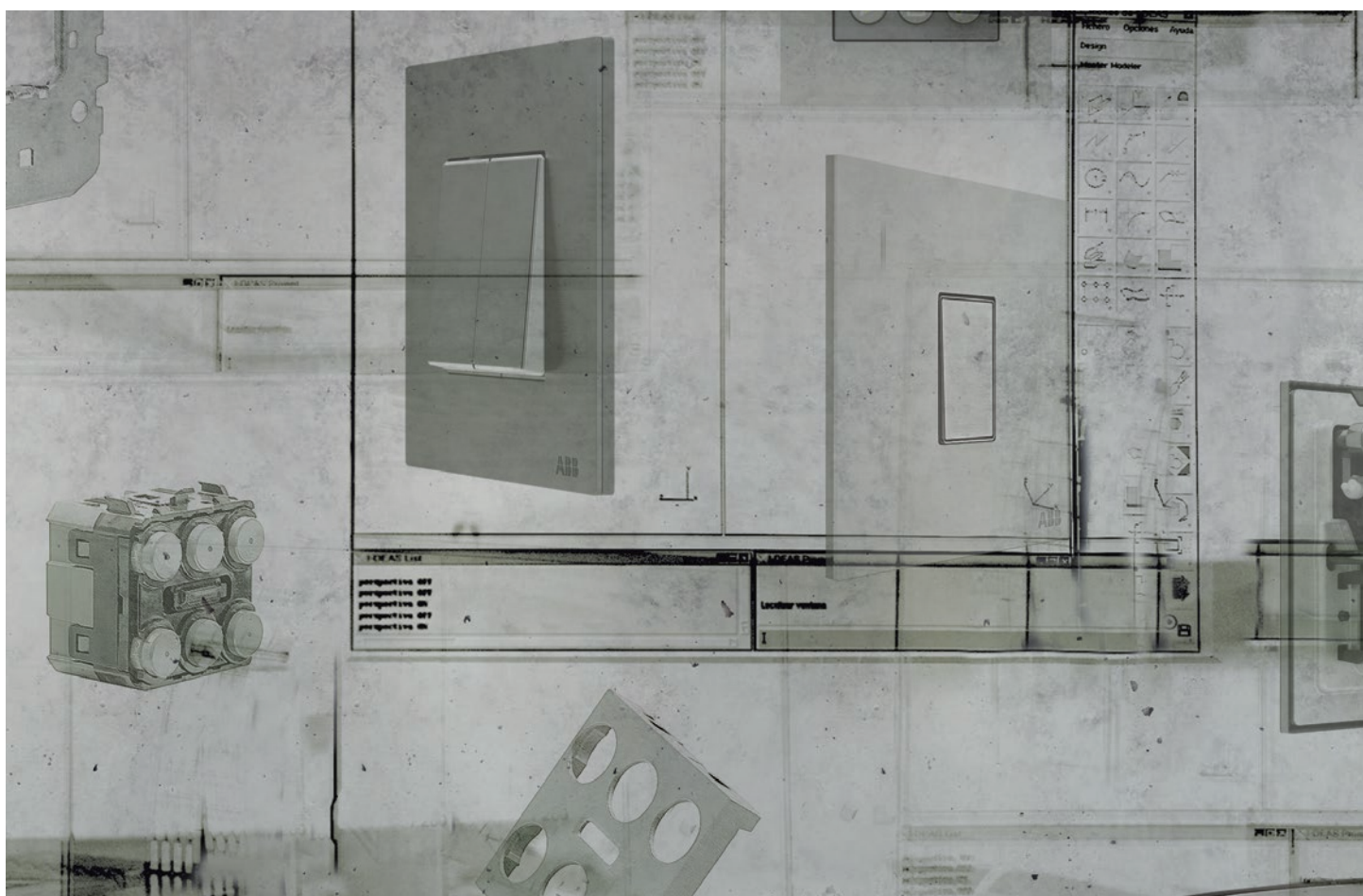

Millenium

Frame dimensions

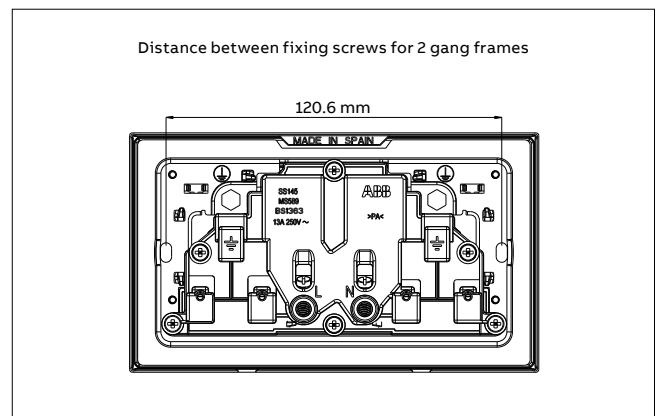
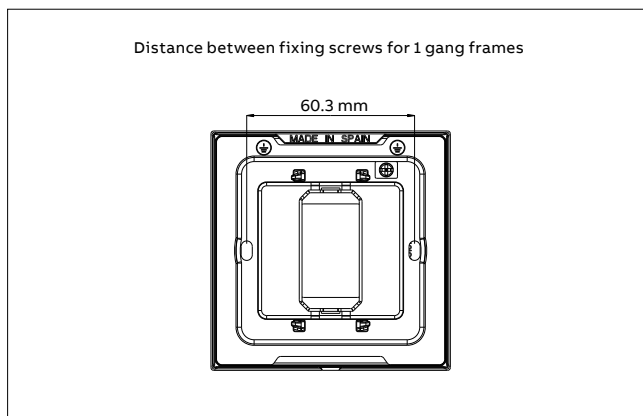
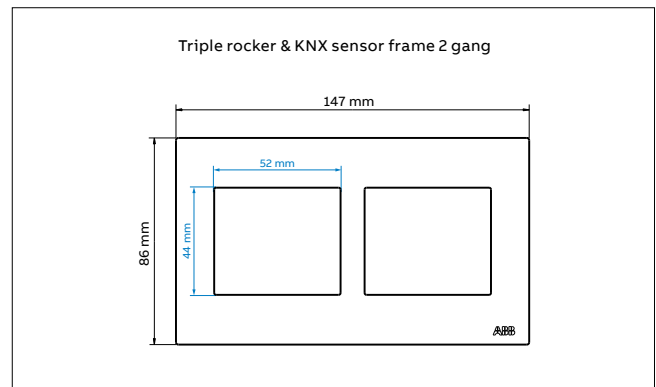
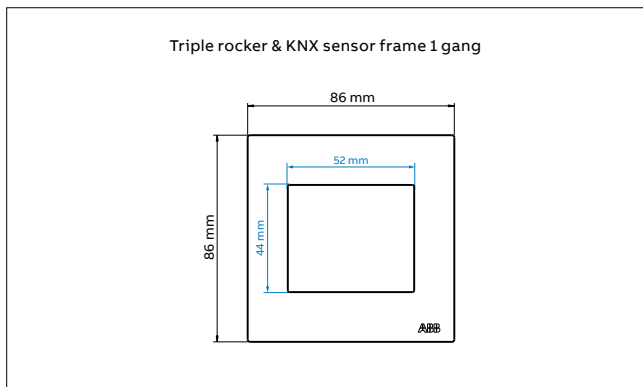
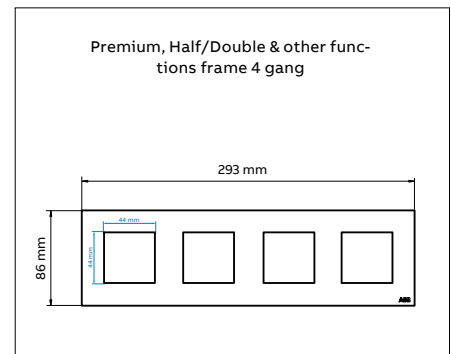
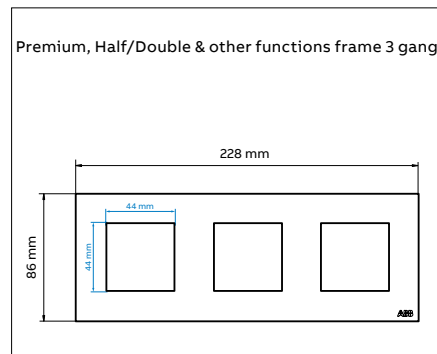
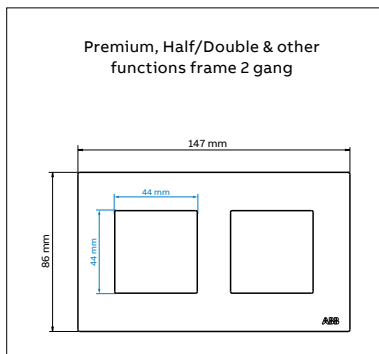
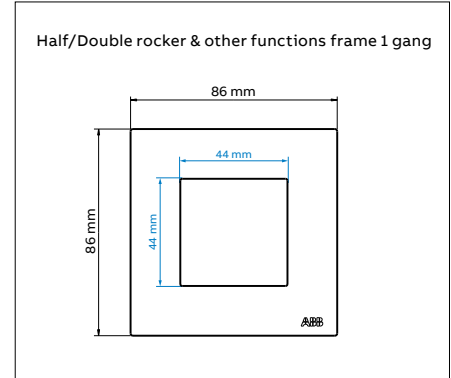
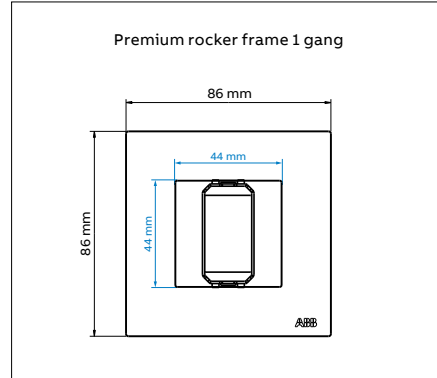
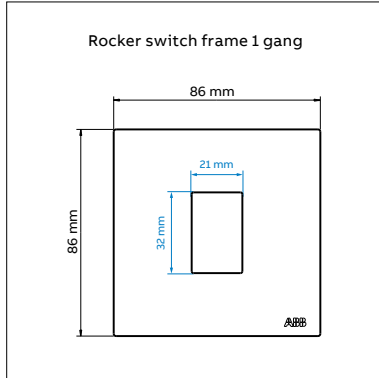

—
Suitable for flush wall boxes of 35 mm minimum except shaver socket. Cooker unit and 45 DP switch.

Millenium

Circuit connection diagrams

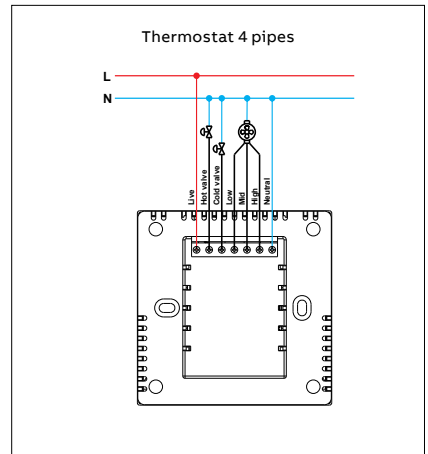
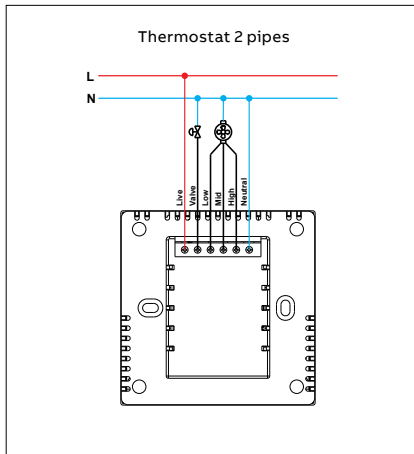
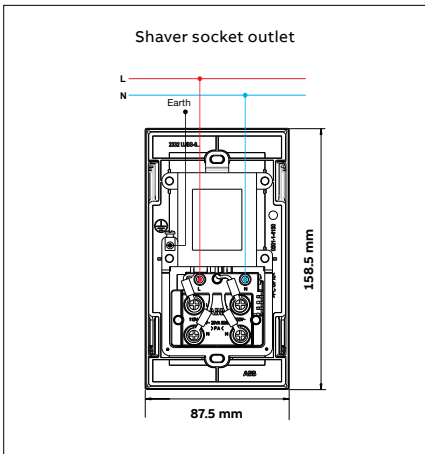
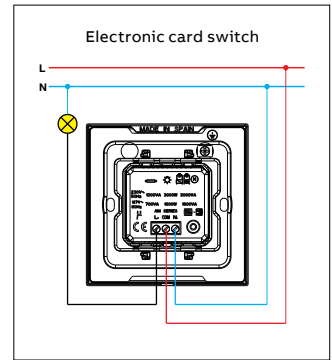
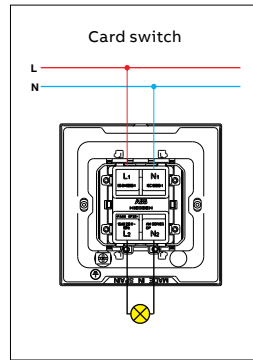
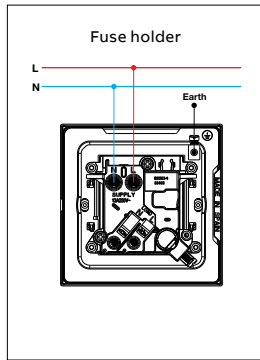
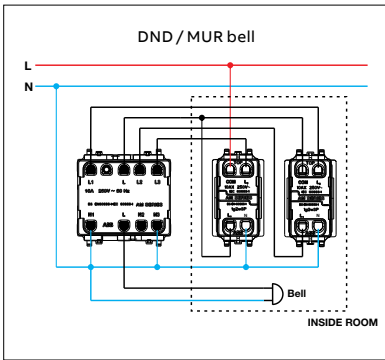
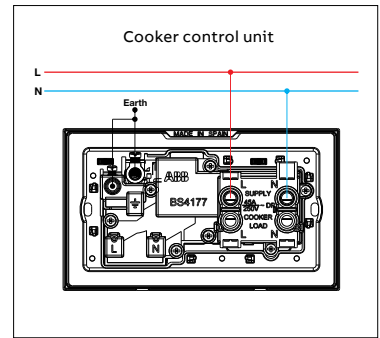
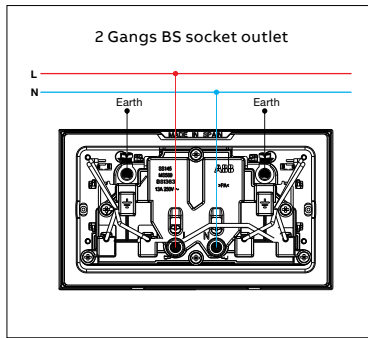
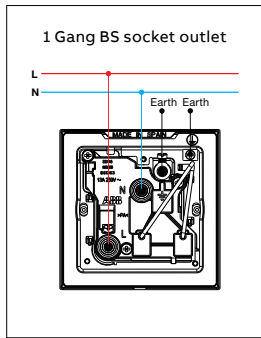
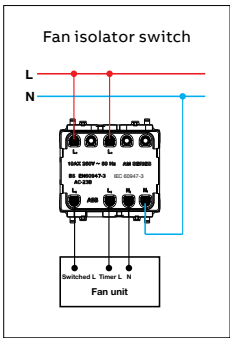
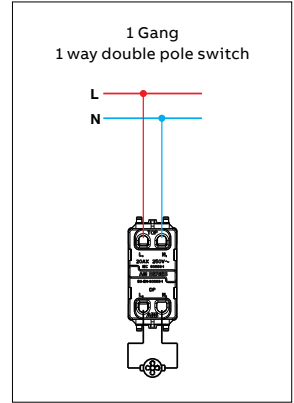
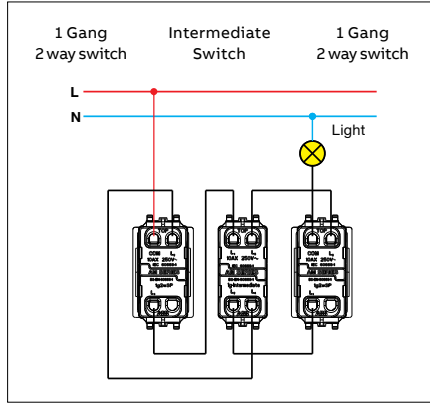
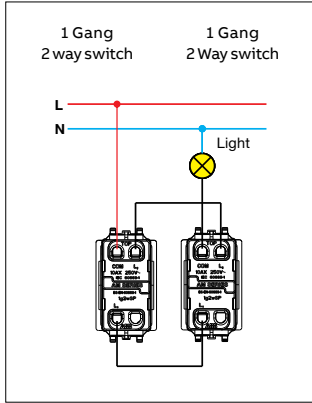
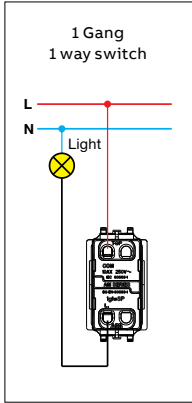

Millenium

Rotary/push dimmer LED AMD60344-AN

1.- Introduction

1. Product to be wired in accordance with wiring diagram.
2. Short circuit and overload will damage product.
3. In case of inductance load, take inductance power loss into account.
4. Please read the installation guide carefully before installation.
5. Electrical installation must be carried out by a qualified electrician in accordance with the accepted wiring practice and relevant regulations.

Disconnect the power during installation.

2.- Technical Characteristics



250 V~ ; ± 10 % ; 50 Hz

LEDi ⁽²⁾

Min./max. Load (230 V~): 2 W / VA, 100 W / VA ⁽²⁾
Num: 10 ⁽³⁾

230 V~ dimmable energy saving lamps ⁽²⁾

Min./max. Load (230 V~): 2 W / VA, 100 W / VA ⁽²⁾
Num: 10 ⁽³⁾

LV LEDi with transformer ^(1,2)

Min./max. Load (230 V~): 4 W / VA, 100 W / VA
Num: 10 ⁽³⁾

230 V~ incandescent lamps

Min./max. Load (230 V~): 10 W / VA, 250 W / VA

230 V~ halogen lamps

Min./max. Load (230 V~): 10 W / VA, 250 W / VA

LV halogen lamps with transformer ⁽¹⁾

Min./max. Load (230 V~): 10 W / VA, 250 W / VA

EMC COMPLIANT ACCORDING IEC 60669-2-1.

3.- Assembly / Connection

3.1 Wiring diagram

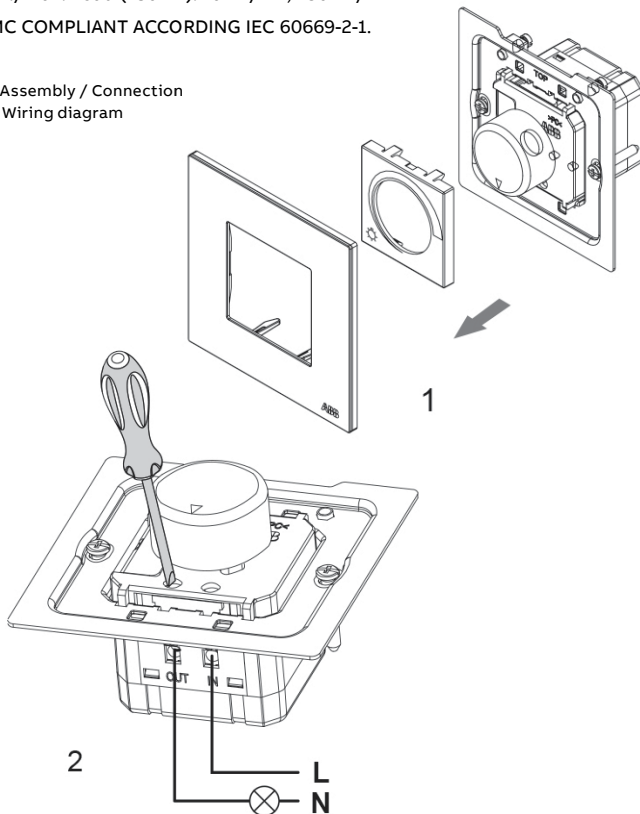

3.2 Installation

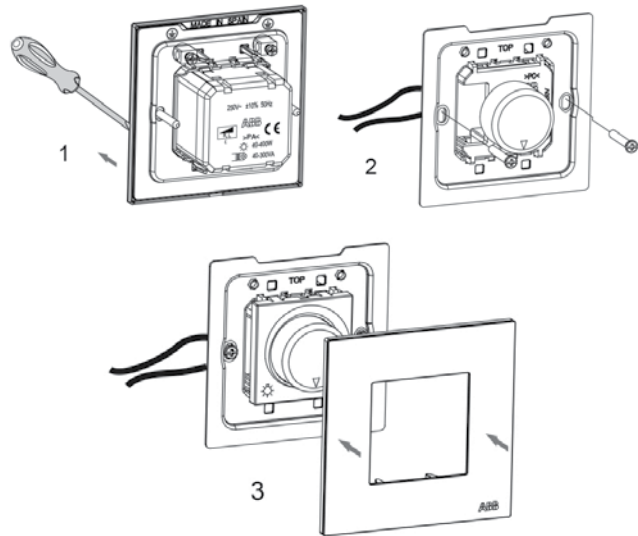

4.- Operation

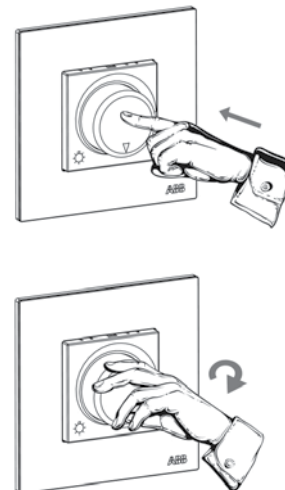

Millenium

Rotary/push dimmer AMD60244-AN

1.- Technical Data

Electrical Characteristics - Power Supply: 230 V~ ; 50 Hz

- **Minimum Power:** 60 W / VA

- **Maximum Power:** 500 W incandescent lamps
500 VA halogen lamps with electronic transformer.
400 VA halogen lamps with ferromagnetic transformer.

- Room temperature for operation: 0 to 30 °C.

Operating Characteristics

- LED indicator pilot **Detecting the Type of Load**

- After wiring the device to the mains voltage, the regulator assesses the characteristics of the load connected.

Overload

- If the device overloads above the maximum permitted nominal power, or if the operating temperature exceeds the maximum, the regulator will automatically stop working as a safety measure.

Short Circuit

In case of short circuit, the device will stop working as a safety measure.

Note: Disconnect the device from the power supply if you are making changes to the load.

2.- Assembly / Connection

2.1 Wiring diagram

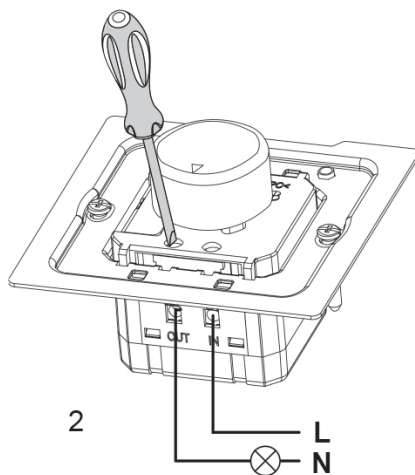
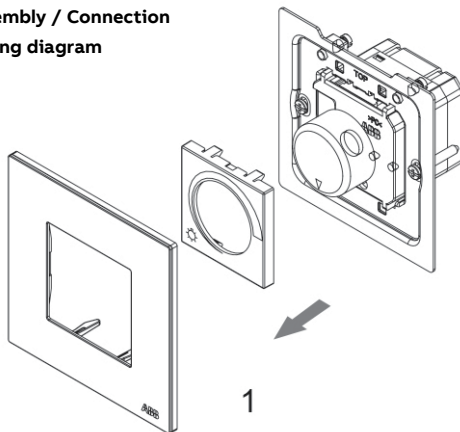

2.2 Installation

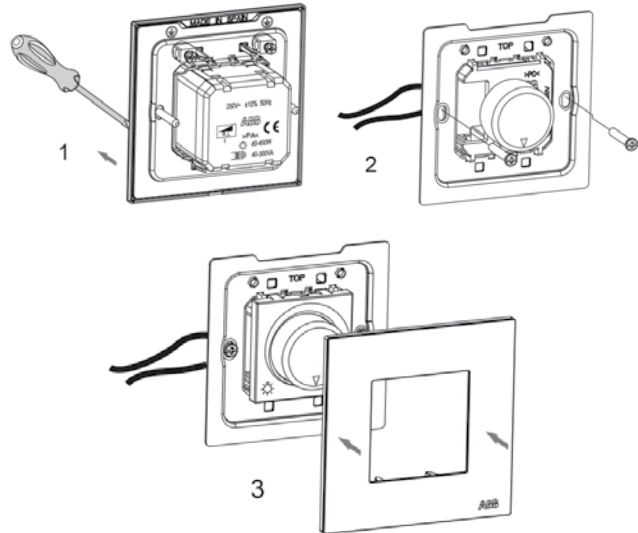

3.- Operation

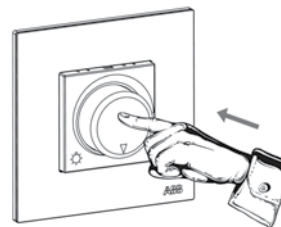

Millenium

Rotary dimmer for fluorescent AMD60944-AN

1.- Technical Data

Power Supply: 230 V~ ; 50 Hz

- **Nominal power:** 700 VA

- **Load type:** Dimmable electronic ballast with 1-10V control input.

2.- Assembly/Connection

2.1.- Connection

Follow the steps below to install the mechanism:

1. Connect the device according to the connection schemes. Figure 2 and Figure 3.
2. Assemble the device on the flush mounting box.
3. Then, place the plate.

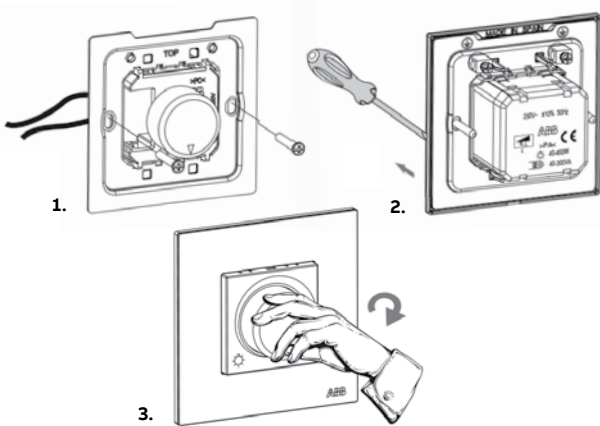

Important: Disconnect the power supply when installing.

2.2.- Connection

The fluorescent lighting dimmer AMD60944-AN may be connected to dimmable electronic ballasts with a control input of 1-10 V as shown in Figure 2:

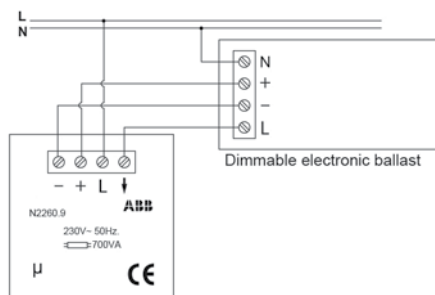

The maximum charge to be connected to the control terminals +/- should not exceed 50 mA.

See technical specifications of the dimmable electronic ballast to be installed.

Electronic ballasts generate a very high instantaneous peak current at connection, therefore it is recommended not to connect more than 6 ballasts to the AMD60944-AN fluorescence regulator.

In installations where it is required to connect more than 6 electronic ballasts to the same regulator mechanism, it is recommended to use a contactor to protect the mechanism contacts. See Figure 3.

3.- Operation button turns in the clockwise direction

If the charge is disconnected, i.e. the rotatory button is completely turned counter-clockwise, when turning right the charge will turn on (a "click" will be heard) and the intensity level will increase as we turn the button in the clockwise direction.

If the charge is at a given point of regulation, the charge intensity will increase as we turn the button in that direction.

If we turn the button completely in the clockwise direction, this will stop in a limit, which will coincide with the maximum regulation intensity level.

Operation button turns in the counter-clockwise direction

Intensity level will reduce as we turn the button in the counter-clockwise direction.

If we turn the button completely in the counter-clockwise direction, a "click" will be heard and the button will stop in a limit, the charge will be disconnected.

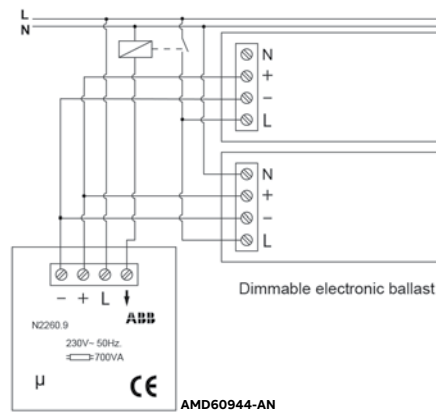

Figure 3: Connection using a contactor

Millenium

LED/Universal rotatory dimmer - 1M
AMD60322 & AM41144

1. Technical data

	Mode	AMD60322 AM41144 (1 module)	
		max ↓ ↓ ↓	max W. 230V~50/60Hz
Leading-Edge	I. LEDi	10	4 - 60 W
	II. LED	10	4 - 60 W
	III. HALOGEN 12V	-	4 - 60 W
Trailing-Edge	IV. LEDi	-	4 - 250 W
	V. LED	-	4 - 250 W
	VI. HALOGEN 12V	-	4 - 250 W
	VII. INCANDESCEN.	-	4 - 250 W

Types of load supported (see table 1)

Leading-edge dimmable loads:

- I. LED lamps at 230V/127V type L
- II. LED lamps at 12V with electronic transformer
- III. Halogen lamps at 12V with electronic transformer

Trailing-edge dimmable loads (recommended):

- IV. LED lamps at 230V/127V type C
- V. LED lamps at 12V with electronic transformer
- VI. Halogen lamps at 12V with electronic transformer

Traditional loads:

- VII. Incandescent and halogen lamps.

Technical data

Nominal input voltage	(see tables 1)
Nominal input frequency	50 / 60Hz
Operating temperature	-5°C... +35°C
Maximum power supported:	(see tables 1 and 2)
Load type selector	Yes
Off position	Yes
Possible extension for ON/OFF	No
Connection wires	2 o 3
Short-circuit & overload protection	Yes
Temperature protection	Yes
IP protection	IP20
Safety standard	IEC 60669-2-1

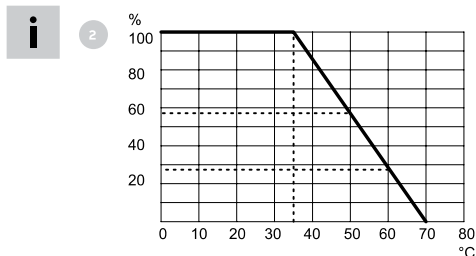

Performance

The dimmer's nominal power will decrease according to ambient temperature in line with the graph. If 2 regulators are installed adjacent, reduce max. power to 50%. If 3 adjacent regulators are installed, reduce max. power to 25%.

2. Wiring diagram

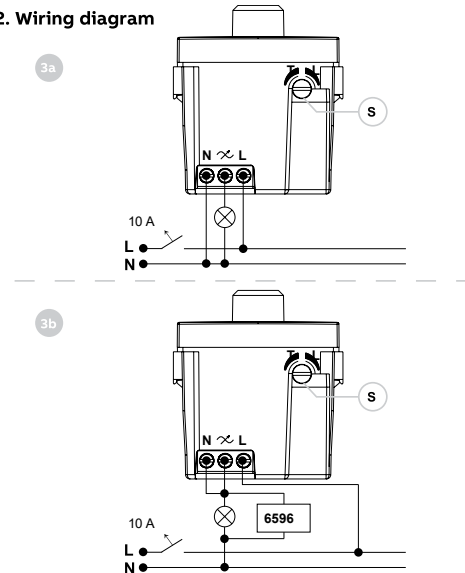

3. Connection

3 WIRES (recommended):

Figure '3a' shows an example of a 3-wire connection.

2 WIRES:

Figure '3b' shows an example of a 2-wire connection. This connection is subject to load compatibility, and correct functioning in all cases cannot be guaranteed (see note above). The minimum load installed must exceed 14W and it must be complemented with a 6596 compensation filter in parallel.

4. Set-up

1. Check the voltage is disconnected.
2. Configure the dimmer functioning mode using the adjustment dial, according to the type of load (see table 1)
3. Place the arrow at the bottom end (-) of the selector dial 'S'
4. Connect all wires through the rear terminals.
5. Make sure that the wires are correctly installed and free of potential short-circuits.
6. Restore the general power supply.
7. Switch on the lamps by turning the dimmer switch.
8. Adjust the minimum threshold by placing the arrow of the selector dial 'S' at the lowest point at which the lamps emit light without flashing.
9. Insert the mechanism in the recess box.

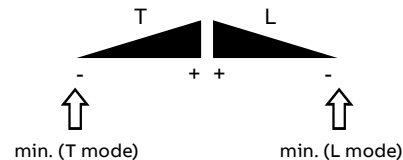

Make sure that the proper functioning mode has been configured (L or T) according to the type of load. Otherwise, the dimmer and the lamp could be damaged.

Note

Given the heterogeneity of the lamps and manufacturers in the market, some LED lamps may not be compatible with the dimmer resulting in persistent flashing problems. To avoid these problems, we recommend using the lamps of recognised manufacturers, avoiding the mixture of models and types whenever this is possible.

Millenium

FM stereo receiver with RDS AMD68044-AN

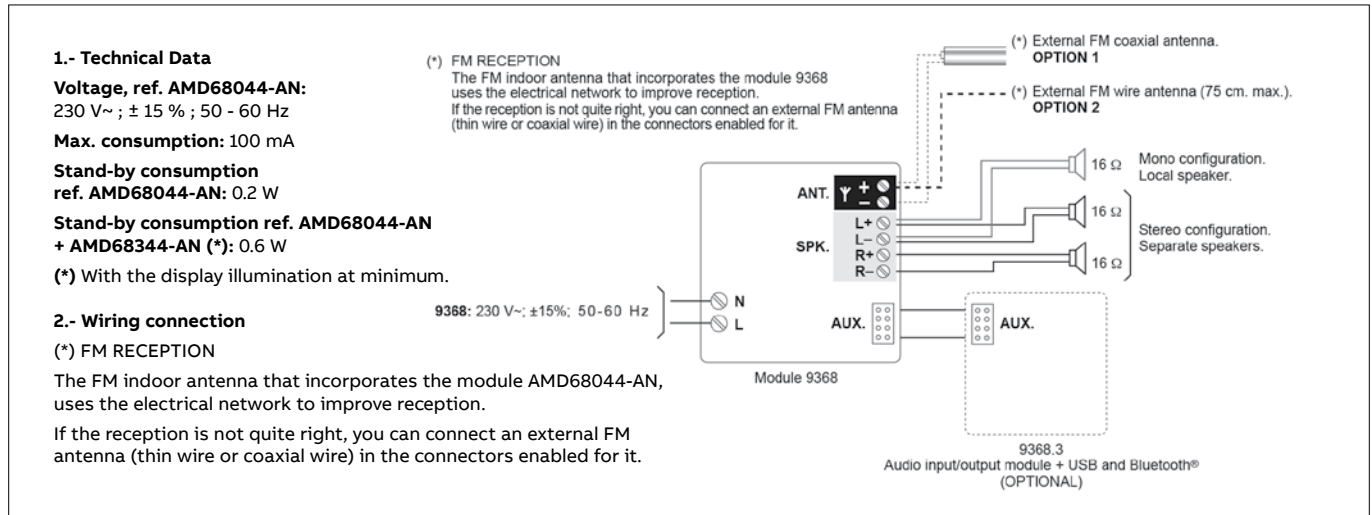

Input/output USB & Bluetooth® module AMD68344-AN

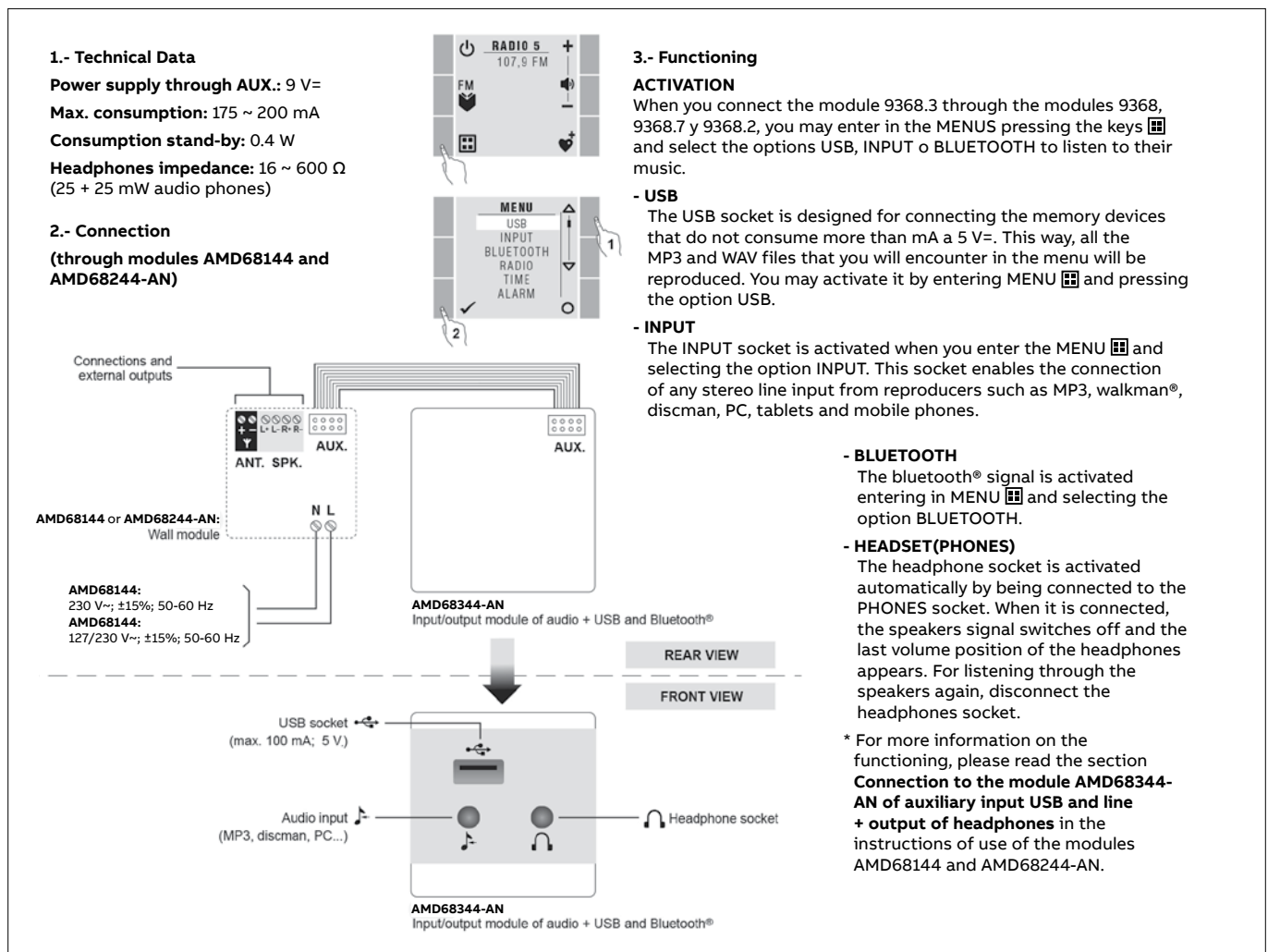

Millenium

Flush-mounted remote control AMD68244-AN

1.- Technical Data

Power supply ref. AMD68144:

230 V~ / 127 V~ ; ± 15 % ; 50 - 60 Hz

Power supply ref. AMD68244-AN:

230 V~ / 127 V~ ; ± 15 % ; 50 - 60 Hz

Bluetooth®:

Maximum reach from the ceiling module
AMD68144 to user's Bluetooth® device: 10 m.

Maximum power consumption ref.

AMD68144: 200 mA

Maximum power consumption ref. AMD68244-AN:

15 mA

Stand-by consumption ref. AMD68144:

0,3 W

Stand-by consumption ref. AMD68244-AN

(*): 0.5 W

Stand-by consumption

ref. AMD68244-AN + AMD68344-AN (*):
0.9 W

(*): With the display illumination at minimum.

Maximum power ref. AMD68144:
6+6 W; <1% distortion (4 W)

Speaker impedance ref. AMD68144:
4 W (6+6 W audio)

2.- Connection

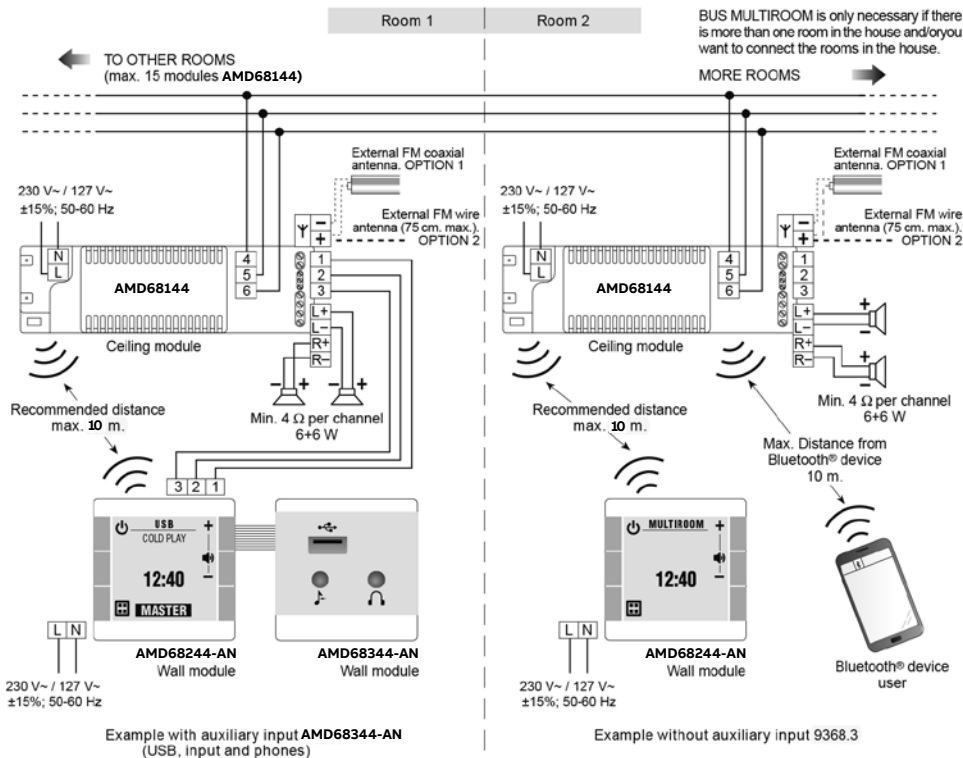

NOTE: Due to the radiofrequency nature of these devices, and in order to avoid possible interactions between them, it is highly recommended NOT TO INSTALL modules of the same reference at less than 1m. Thereby avoiding group assembly.

3.- Linking modules AMD68144 and AMD68244-AN

Important:

Modules AMD68144 and AMD68244-AN only work if both are interlinked by radio.

Module AMD68244-AN has to be connected by radio with ceiling module AMD68144, and only when this bond is created, can the system work efficiently.

Linking:

In order to connect two modules, make sure the connection diagram is similar to the one shown above, and that both modules are linked to the electricity network.

Then, access the rear of the ceiling module AMD68144 and press the internal key CONNECT with a clip or micro-screwdriver.

Once you have pressed the button you have got two minutes to go to the second module AMD68244-AN (the one you want to link with) and press simultaneously the keys **⏏** during two seconds.

When the two modules are associated, the screen should read "LINKED TO NEW EQUIPMENT".

Note:

It is important that the process of connection between various equipments is done step-by-step, by matching each module AMD68144 to each AMD68244-AN selected.

If not, a faulty connection may occur.

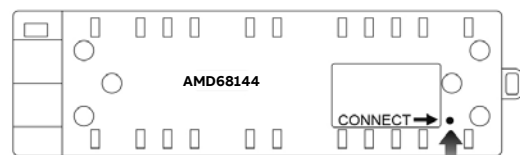

Back of ref. 9368.1 to access key internal CONNECT.

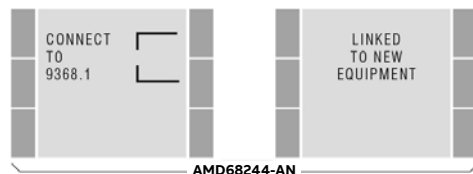

Millenium

Radio/amplifier module for ceiling with Bluetooth® AMD68144-AN

1.- Technical Data

Power supply:
230 V~ / 127 V~ ; ± 15 % ; 50 - 60 Hz

Bluetooth®:
Maximum reach from the ceiling module AMD68144 to user's Bluetooth® device: 10 m.

Maximum power consumption:
200 mA

Consumption stand-by:
0.3 W

Antenna impedance:
75 Ω

Maximum power headphone output:
6 + 6 W ; < 1 % distortion (4 Ω)

Minimum impedance of headphones:
4 Ω (6+6 W audio)

2.- Connection

BUS MULTIROOM is only necessary if there is more than one room in the house and/or you want to connect the rooms in the house.

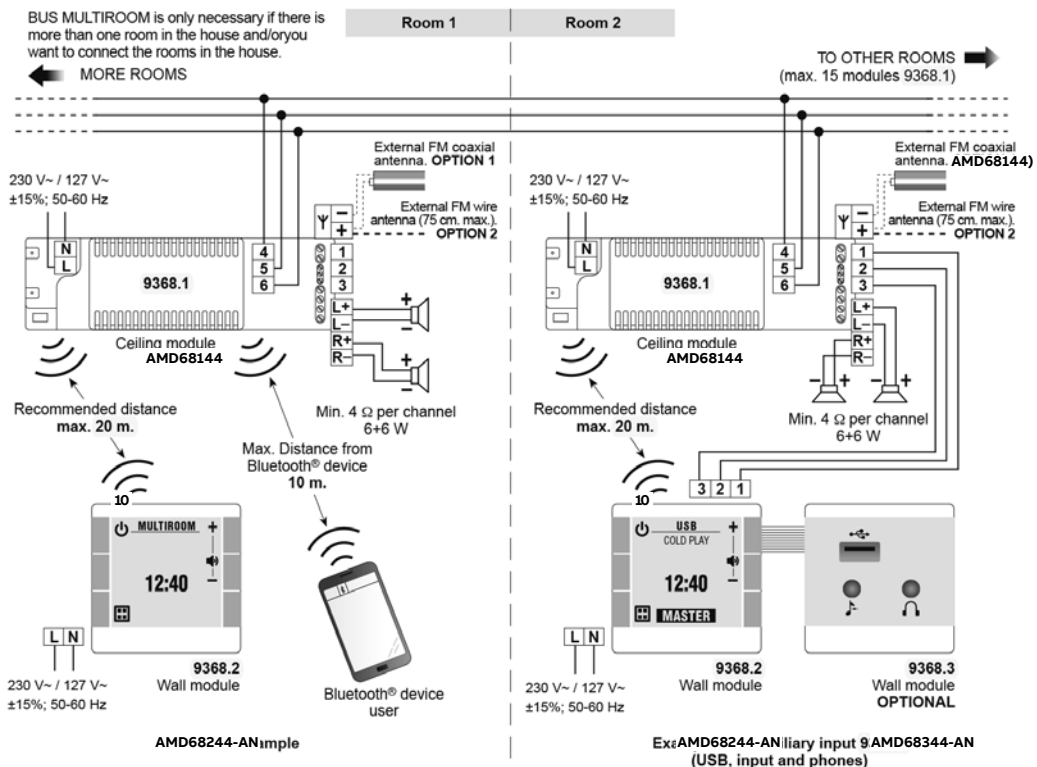

NOTE: Due to the radiofrequency nature of these devices, and in order to avoid possible interactions between them, it is highly recommended NOT TO INSTALL modules of the same reference at less than 1m. Thereby avoiding group assembly. **AMD68344-AN**

3.- Linking modules AMD68144 and AMD68244-AN

Important:

Modules AMD68144 and AMD68244-AN only work if both are interlinked by radio.

Module AMD68244-AN has to be connected by radio with ceiling module AMD68144, and only when this bond is created, can the system work efficiently.

Linking:

In order to connect two modules, make sure the connection diagram is similar to the one shown above, and that both modules are linked to the electricity network.

Then, access the rear of the ceiling module AMD68144 and press the internal key **CONNECT** with a clip or micro-screwdriver.

Once you have pressed the button you have got two minutes to go to the second module AMD68244-AN (the one you want to link with) and press simultaneously the keys **CONNECT** during two seconds.

When the two modules are associated, the screen should read "LINKED TO NEW EQUIPMENT".

Note:

It is important that the process of connection between various equipments is done step-by-step, by matching each module AMD68144 to each AMD68244-AN selected.

If not, a faulty connection may occur.

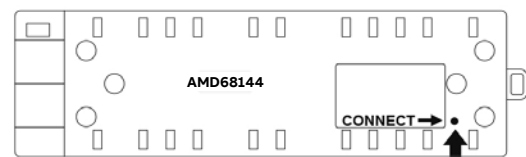

Back of ref. 9368.1 to access key internal **CONNECT**.

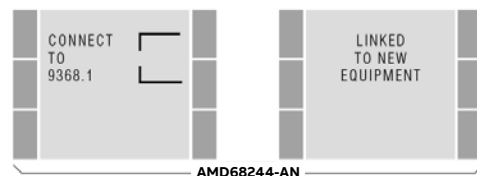

* For more information on the functioning of the system, please read the instructions for use of the module

Millenium - Combination sets (AMD)

International standards

Product description	Standard	Description
Switches	BS EN 60669-1 / IEC 60669-1 / SS 227 / MS IEC 60669-1	Switches for household and similar fixed electrical installation
Fan isolator 3 pole	IEC 60947-1 / IEC 60947-3 BS EN 60947-1 / BS EN 60647-3	Low-voltage switchgear and controlgear-Part 3: switches, disconnectors, switch-disconnectors and fuse-combination units
Fused Connection Unit	BS 1363-4 / SS403	Specification for 13A fused connection units switched and unswitched
20A / 32A / 45A double pole switches	IEC 60669-1	Switches for household and similar fixed electrical installation
45A Cooker control unit	BS 4177	Cooker control unit
13A socket outlets	BS 1363-2 / SS 145 / SASO 2023 / MS 589-2	13A switched and unswitched socket outlets
13A socket outlets with USB charger	BS 1363-2 / SASO 2023 / SS 145-2	13A switched and unswitched socket outlets with USB charger
15A socket outlets	BS 546 / SS 472 / MS 1577	Two-pole and earthing-pin plugs, socket outlets and socket-outlet adaptors
5A socket outlets	BS 546	Two-pole and earthing-pin plugs, socket outlets and socket-outlet adaptors
20A Connection Units	BS 5733 / MS 1144	General requirements for electrical accessories
Universal socket outlets	BS 5733	General requirements for electrical accessories
Telephone outlet RJ11, 4-pole	TIA / EIA 568-A,568-B	Commercial building telecommunications cabling standard-Part2: Balanced twisted pair cabling components
BS Telephone outlet, 6-pole	BS 6312-2-1 / BS 6312-2-2.2	Connectors for analogue telecommunication interfaces
Computer outlet RJ45, 8-pole	TIA / EIA 568-A, 568-B	Commercial building telecommunications cabling standard-Part2: Balanced twisted pair cabling components
TV outlet	BS 3041-2 / IEC 60169-2	Radio-frequency connectors. Specification for coaxial unmatched connector
Shaver Unit	IEC 61558-1 / IEC61558-2-5	Safety of transformers, reactors, power supply units and combinations thereof - Part 2-5: Particular requirements and test for transformer
Electronic Switches	IEC 60669-2-1	Switches for household and similar fixed electrical installations-Part 2-1: Particular requirements-Electronics switches
Thermostat Controller	IEC 60730-1 / IEC60730-2-9	Automatic electrical controls for household and similar use-Part 2-9: Particular requirements for temperature sensing controls
Frames and plates	BS 5733 / MS 1144	Specification for general requirements for electrical accessories

*Maximum rated power for Self Ballast Lamp Loads according to IEC 60669-1: 2017, clause 8

Rated current i (A)	Max. power of the SBL circuit (W)
$i \leq 10$	100
$10 < i \leq 13$	150
$13 < i \leq 16$	200
$16 < i \leq 20$	250

Millenium

List of products

Code	Finished	Pack. (unit)	Page
9399		12	44
803.2		1	27
9329.1		1	43
9368.1		10	43
9399.1		12	43
9399.2		12	43
AM10120	ST	1	19
AM10144	ST	1	20
AM10244	ST	1	21
AM10520	ST	1	19
AM10544	ST	1	20
AM10644	ST	1	21
AM10753	ST	1	21
AM10920	ST	1	19
AM11020	ST	1	19
AM11044	ST	1	20
AM11120	ST	1	19
AM11144	ST	1	20
AM11244	ST	1	20
AM11444	ST	1	21
AM11520	ST	1	19
AM11544	ST	1	20
AM11644	ST	1	21
AM118147	ST, SB, MG, AG, DU, MO, WG, BG	1	23
AM11844	ST	1	27
AM11920	ST	1	19
AM11944	ST	1	20
AM12153	ST	1	21
AM13444	ST	1	21
AM17744	ST, SB, MG, AG, DU, MO, WG, BG	1	20
AM17844	ST, SB, MG, AG, DU, MO, WG, BG	1	20
AM19188	ST	1	21
AM19588	ST	1	21
AM20986	ST, SB, MG, AG, DU, MO, WG, BG	1	24
AM22186	ST, SB, MG, AG, DU, MO, WG, BG	1	24
AM23186	ST, SB, MG, AG, DU, MO, WG, BG	1	24
AM23386	ST, SB, MG, AG, DU, MO, WG, BG	1	22
AM23486	ST, SB, MG, AG, DU, MO, WG, BG	1	22
AM23586	ST, SB, MG, AG, DU, MO, WG, BG	1	25
AM242147	ST, SB, MG, AG, DU, MO, WG, BG	1	25
AM235147	ST, SB, MG, AG, DU, MO, WG, BG	1	25
AM236147	ST, SB, MG, AG, DU, MO, WG, BG	1	25

Code	Finished	Pack. (unit)	Page
AM242147	ST, SB, MG, AG, DU, MO, WG, BG	1	25
AM23686	ST, SB, MG, AG, DU, MO, WG, BG	1	25
AM23786	ST, SB, MG, AG, DU, MO, WG, BG	1	22
AM23886	ST, SB, MG, AG, DU, MO, WG, BG	1	22
AM239147	ST, SB, MG, AG, DU, MO, WG, BG	1	22
AM240147	ST, SB, MG, AG, DU, MO, WG, BG	1	22
AM29486	ST, SB, MG, AG, DU, MO, WG, BG	1	24
AM24286	ST, SB, MG, AG, DU, MO, WG, BG	1	25
AM40188	ST, SB, MG, AG, DU, MO, WG, BG	1	27
AM40244	ST, SB, MG, AG, DU, MO, WG, BG	1	27
AM40344	ST	1	27
AM40444	ST	1	27
AM40544	ST, SB, MG, AG, DU, MO, WG, BG	1	27
AM41144	ST, SB, MG, AG, DU, MO, WG, BG	1	26
AM41344	ST, SB, MG, AG, DU, MO, WG, BG	1	26
AM42920	ST	1	19
AM42944	ST	1	20
AM43020	ST	1	19
AM43044	ST	1	20
AM43053	ST	1	21
AM50093	BL	1	27
AM50100	CH	10	29
AM50200	CH	10	29
AM50300	CH	10	29
AM50400	CH	10	29
AM50444	CH	10	
AM50444	CH	1	26
AM50500	CH	10	29
AM50600	ST, SB, MG, AG, DU, MO, WG, BG	10	43
AM50653	ST, SB, MG, AG, DU, MO, WG, BG	1	26
AM50701	GR, WH	10	46
AM50702	GR, WH	10	46
AM50703	GR, WH	10	46
AM50704	GR, WH	10	46
AM50705	GR, WH	10	46
AM50706	GR, WH	10	46
AM50753	ST, SB, MG, AG, DU, MO, WG, BG	1	26
AM50853	ST, SB, MG, AG, DU, MO, WG, BG	1	26

Millenium

List of products

Code	Finished	Pack. (unit)	Page
AM55044	ST, SB, MG, AG, DU, MO, WG, BG	1	26
AM56086	AN, WP	1	26
AMD10120	ST, SB, MG, AG, DU, MO, WG, BG	10	28
AMD10144	WG, BG	5	30
AMD10144	ST, SB, MG, DU, MO, AG	10	30
AMD10222	WG, BG	5	32
AMD10222	ST, SB, AG, MG, DU, MO	10	32
AMD10520	ST, SB, MG, AG, DU, MO, WG, BG	10	28
AMD10520	ST, SB, MG, DU, MO, AG	5	28
AMD10544	WG, BG	5	30
AMD10544	ST, SB, MG, DU, MO, AG	10	30
AMD10622	WG, BG	5	32
AMD10622	ST, SB, AG, MG, DU, MO	10	32
AMD10753	WG, BG	5	34
AMD10753	ST, SB, AG, MG, DU, MO	10	34
AMD10920	WG, BG	5	29
AMD10920	ST, SB, MG, AG, DU, MO, WG, BG	10	29
AMD11020	ST, SB, MG, AG, DU, MO	10	28
AMD11044	WG, BG	5	30
AMD11044	ST, SB, MG, DU, MO, AG	10	30
AMD11120	WG, BG	5	29
AMD11120	ST, SB, MG, DU, MO, AG	10	29
AMD11140	WG, BG	5	31
AMD11140	ST, SB, MG, DU, MO, AG	10	31
AMD11240	WG, BG	5	31
AMD11240	ST, SB, MG, DU, MO, AG	10	31
AMD11422	WG, BG	5	32
AMD11422	ST, SB, AG, MG, DU, MO	10	32
AMD11520	ST, SB, MG, AG, DU, MO, WG, BG	10	29
AMD11520	WG, BG	5	29
AMD11544	WG, BG	5	30
AMD11544	ST, SB, MG, DU, MO, AG	10	30
AMD11622	WG, BG	5	32
AMD11622	ST, SB, MG, AG, DU, MO	10	32
AMD11722	WG, BG	5	33
AMD11722	ST, SB, MG, AG, DU, MO	10	33
AMD11822	WG, BG	5	33
AMD11822	ST, SB, MG, AG, DU, MO	10	33
AMD11844	WG, BG	5	42
AMD11844	ST, SB, MG, AG, DU, MO	5	42
AMD11920	ST, SB, MG, AG, DU, MO, WG, BG	10	28
AMD11920	ST, SB, MG, DU, MO, AG	5	28
AMD11944	WG, BG	5	30
AMD11944	ST, SB, MG, DU, MO, AG	10	30
AMD12153	WG, BG	5	34
AMD12153	ST, SB, MG, AG, DU, MO	10	34

Code	Finished	Pack. (unit)	Page
AMD12922	WG, BG	5	32
AMD12922	ST, SB, AG, MG, DU, MO	10	32
AMD13444	WG, BG	5	43
AMD13444	ST, SB, AG, MG, DU, MO	10	31
AMD19144	AN, WP	5	41
AMD24144	AN, WP	5	41
AMD33144	AN, WP	10	40
AMD33244	AN, WP	10	40
AMD33544	AN, WP	5	40
AMD33644	ST, SB, MG, AG, DU, MO, WG, BG	5	40
AMD40344	ST, SB, MG, AG, DU, MO, WG, BG	5	42
AMD40444	ST, SB, MG, AG, DU, MO, WG, BG	5	42
AMD42920	WG, BG	5	29
AMD42920	ST, SB, MG, DU, MO, AG	10	29
AMD42944	ST, SB, MG, DU, MO, AG	10	31
AMD42944	WG, BG	5	31
AMD43020	WG, BG	5	29
AMD43020	ST, SB, MG, DU, MO, AG	10	29
AMD43044	WG, BG	5	31
AMD43044	ST, SB, AG, MG, DU, MO	10	31
AMD43053	WG, BG	5	34
AMD43053	ST, SB, MG, AG, DU, MO	5	34
AMD43222	WG, BG	10	33
AMD43222	AP, BL	5	33
AMD5044	WG, BG	4	48
AMD5044	ST, SB, AG, MG, DU, MO	10	48
AMD5120	WG, BG	4	49
AMD5120	ST, SB, AG, MG, DU, MO	10	49
AMD5144	ST, SB, AG, MG, DU, MO	10	48
AMD5153	ST, SB, AG, MG, DU, MO	10	49
AMD5244	WG, BG	5	48
AMD5244	ST, SB, AG, MG, DU, MO	10	48
AMD5253	WG, BG	5	49
AMD5253	ST, SB, AG, MG, DU, MO	10	49
AMD5344	WG, BG	2	48
AMD5344	ST, SB, AG, MG, DU, MO	5	48
AMD5444	WG, BG	2	48
AMD5444	ST, SB, AG, MG, DU, MO	5	48
AMD55222	AN, WP	1	41
AMD55322	AN, WP	1	41
AMD55422	AN, WP	1	41
AMD55522	AN, WP	1	41
AMD55722	AN, WP	1	41
AMD55922		1	41
AMD6016		10	40
AMD6016.1		10	40
AMD6016.2		10	40
AMD6016.3	AN, WP	10	40

Millenium



















List of products

Code	Finished	Pack. (unit)	Page
AMD68044	AN, WP	1	43
AMD68244	AN, WP	1	43
AMD68344	AN, WP	1	43
AMD68444	AN, WP	1	43
AMD70053	AN, WP	1	46
SSA-F-1.1.PB.1	WL	1	44
SDA-F-1.1.PB.1	WL	1	44
SBA-F-1.1.PB.1	WL	1	44
SU-F-1.0.PB.1	WL	1	44
SR-2-AMAN		5	44
SR-2-AMWP		5	44
SSA-F-2.1.PB.1	WL	1	44
SSA-F-2.2.PB.1	WL	1	44
SDA-F-2.1.PB.1	WL	1	45
SBA-F-2.1.PB.1	WL	1	45
SU-F-2.0.PB.1	WL	1	45
SR-4-AMAN		5	45
SR-4-AMWP		5	45
RTC-F-1.PB	WL	1	45
CP-RTC-AMAN		5	45
CP-RTC-AMWP		5	45
MSA-F-1.1.PB.1	WL	1	45
CP-MD-AMAN		5	45
CP-MD-AMWP		5	45
TR/U 1.1		1	47
TH/U 1.1		1	47
TS/T 1		1	47
SW MiniMAC 4.1		1	47
SBL-AMAN	Light Anthracite P	20	45
SBL-AMWP	Light White	20	45
SBB-AMAN	Blind Anthracite P	20	45
SBB-AMWP	Blind White	20	45
SBS-AMAN	Scene Anthracite P	20	45
SBS-AMWP	Scene White	20	45
SBD-AMAN	Dimmer Anthracite	20	45
SBD-AMWP	Dimmer White	20	45
AMD70153	AN, WP	1	46
AMD72053	AN, WP	1	46
AMD74053	AN, WP	1	46
AMD76053	AN, WP	1	46
AMD76153	WG, BG	1	46
N2100	AP, BL	1	41
N2117.6	AP, BL	10	39
N2118.6	AP, BL	10	39
N2118.7	AP, BL	10	39
N2133	AP, BL	20	36
N2138	AP, BL	20	36
N2150	AP, BL	10	38
N2150.7	AP, BL	10	38
N2151.7	AP, BL	10	38

Code	Finished	Pack. (unit)	Page
N2160.3	AP, BL	1	35
N2185.2	AP, BL	1	37
N2200	AP, BL	1	41
N2214.1	AP, BL	10	42
N2214.5	AP, BL	1	42
N2214.6	AP, BL	1	42
N2217.6	AP, BL	10	39
N2218.6	AP, BL	10	39
N2218.7	AP, BL	10	39
N2237	AP, BL	10	36
N2238	AP, BL	10	36
N2239	AP, BL	10	36
N2250	AP, BL	10	38
N2250.7	AP, BL	10	38
N2260.3	AP, BL	1	35
N2260.9	AP, BL	1	35
N2285.1	AP, BL	1	37
N2288	AP, BL	10	36

Frame selection chart

Select the right frame for each function size:

		1-gang	2-gang	3-gang	4-gang
Function size (mm)		BS standard 3x3"	BS standard 6x3"	ABB Custom box model 1099	ABB Custom box model 1099
	Screw distance Box Dimensions	 60.3 mm 72 mm (H) x 72 mm (W) x 35 mm (D)	 120.6 mm 132 mm (H) x 72 mm (W) x 35 mm (D)	 60 mm x 3 boxes 65 mm (H) x 65 mm (H) x 40 mm (D)	 60 mm x 4 boxes 65 mm (H) x 65 mm (H) x 40 mm (D)
22 x 44 (H x W)	Small rocker switches 	AMD5120  Window 22 x 44 -Single			
44 x 44 (H x W)	Premium rocker switches 	AMD5044  Window 44 x 44 -Single	AMD5244  Window 44 x 44 - Multifunction	AMD5344  Window 44 x 44 - Multifunction	AMD5444  Window 44 x 44 - Multifunction
44 x 44 (H x W)	Function combinations 	AMD5144  Window 44 x 44 - Multifunction	AMD5244  Window 44 x 44 - Multifunction	AMD5344  Window 44 x 44 - Multifunction	AMD5444  Window 44 x 44 - Multifunction
53 x 44 (H x W)	Triple rocker switches 	AMD5153  Window 53 x 44	AMD5253  Window 53 x 44		

Cleaning the products

Clean the surface with a cloth.

Do not use acetone, tar-removing cleaning agents or trichloroethylene.

Resistance to the following cleaning substances:

Hexane (EN 60669-1), Methylated spirit, Soapy water, Diluted ammonia, Pure bleach diluted to 10%, Window-cleaning products, Pre-impregnated wipes

Caution: Always test before using other special cleaning products.



Asea Brown Boveri, S.A.
Fábrica Niessen

Pol. Ind. de Aranguren, 6
20180 OIARTZUN
Spain
Tel.: +34 943 260 101
Fax: +34 943 260 240
www.abb.es/niessen

